

MITSUBISHI THYRISTOR MODULES
TM400HA-M,-H,-24,-2H

MEDIUM POWER GENERAL USE
 INSULATED TYPE

TM400HA-M,-H,-24,-2H



- **IT (AV)** Average on-state current **400A**
- **VRRM** Repetitive peak reverse voltage
 **400/800/1200/1600V**
- **VDRM** Repetitive peak off-state voltage
 **400/800/1200/1600V**
- **ONE ARM**
- **Insulated Type**
- **UL Recognized**

Yellow Card No. E80276 (N)
 File No. E80271

APPLICATION

DC motor control, NC equipment, AC motor control, Contactless switches,
 Electric furnace temperature control, Light dimmers

OUTLINE DRAWING & CIRCUIT DIAGRAM

Dimensions in mm

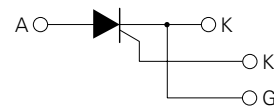
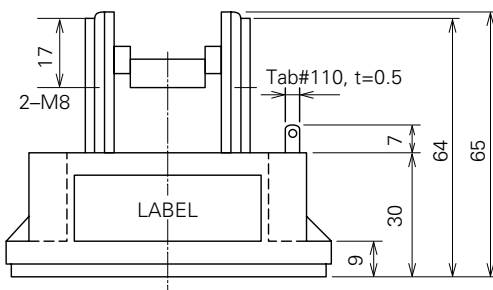
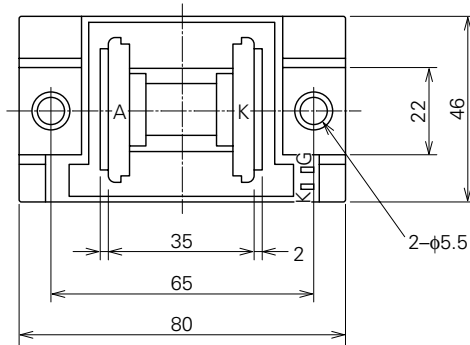

TM400HA-M,-H,-24,-2H

MEDIUM POWER GENERAL USE

INSULATED TYPE

ABSOLUTE MAXIMUM RATINGS

Symbol	Parameter	Voltage class				Unit
		M	H	24	2H	
VRRM	Repetitive peak reverse voltage	400	800	1200	1600	V
VRSM	Non-repetitive peak reverse voltage	480	960	1350	1700	V
VR (DC)	DC reverse voltage	320	640	960	1280	V
VDRM	Repetitive peak off-state voltage	400	800	1200	1600	V
VDSM	Non-repetitive peak off-state voltage	480	960	1350	1700	V
VD (DC)	DC off-state voltage	320	640	960	1280	V

Symbol	Parameter	Conditions	Ratings	Unit
IT (RMS)	RMS on-state current		620	A
IT (AV)	Average on-state current	Single-phase, half-wave 180° conduction, Tc=66°C	400	A
ITSM	Surge (non-repetitive) on-state current	One half cycle at 60Hz, peak value	8000	A
I ² t	I ² t for fusing	Value for one cycle of surge current	2.7 × 10 ⁵	A ² s
di/dt	Critical rate of rise of on-state current	V _D =1/2V _{DRM} , I _G =1.0A, T _j =125°C	100	A/μs
PGM	Peak gate power dissipation		10	W
PG (AV)	Average gate power dissipation		3.0	W
VFGM	Peak gate forward voltage		10	V
VRGM	Peak gate reverse voltage		5.0	V
IFGM	Peak gate forward current		4.0	A
T _j	Junction temperature		-40~+125	°C
T _{stg}	Storage temperature		-40~+125	°C
V _{iso}	Isolation voltage	Charged part to case	2500	V
—	Mounting torque	Main terminal screw M8	8.83~10.8	N·m
			90~110	kg·cm
		Mounting screw M5	1.47~1.96	N·m
			15~20	kg·cm
—	Weight	Typical value	450	g

ELECTRICAL CHARACTERISTICS

Symbol	Parameter	Test conditions	Limits			Unit
			Min.	Typ.	Max.	
I _{RRM}	Repetitive peak reverse current	T _j =125°C, V _{RRM} applied	—	—	40	mA
I _{DRM}	Repetitive peak off-state current	T _j =125°C, V _{DRM} applied	—	—	40	mA
V _{TM}	On-state voltage	T _j =125°C, I _{TM} =1200A, instantaneous meas.	—	—	1.4	V
dv/dt	Critical rate of rise of off-state voltage	T _j =125°C, V _D =2/3V _{DRM}	500	—	—	V/μs
V _{GT}	Gate trigger voltage	T _j =25°C, V _D =6V, R _L =2Ω	—	—	3.0	V
V _{GD}	Gate non-trigger voltage	T _j =125°C, V _D =1/2V _{DRM}	0.25	—	—	V
I _{GT}	Gate trigger current	T _j =25°C, V _D =6V, R _L =2Ω	15	—	100	mA
R _{th (j-c)}	Thermal resistance	Junction to case, per 1/2 module	—	—	0.1	°C/W
R _{th (c-f)}	Contact thermal resistance	Case to fin, conductive grease applied, per 1/2 module	—	—	0.08	°C/W
—	Insulation resistance	Measured with a 500V megohmmeter between main terminal and case	10	—	—	MΩ

TM400HA-M,-H,-24,-2H

MEDIUM POWER GENERAL USE
INSULATED TYPE

PERFORMANCE CURVES

MAXIMUM ON-STATE CHARACTERISTIC

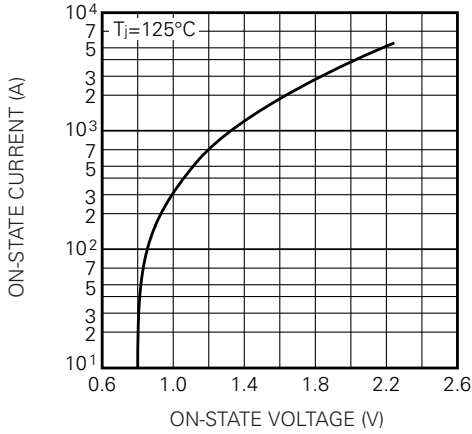

RATED SURGE (NON-REPETITIVE) ON-STATE CURRENT

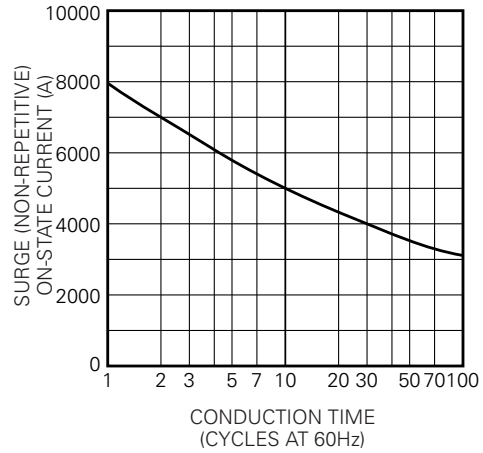

GATE CHARACTERISTICS

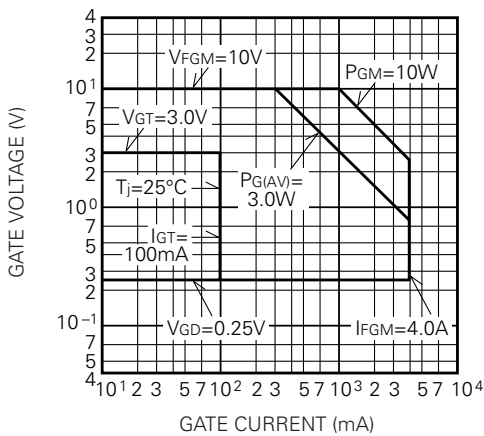

MAXIMUM TRANSIENT THERMAL IMPEDANCE (JUNCTION TO CASE)

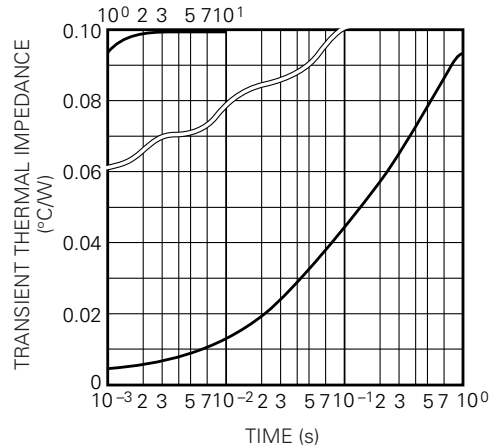

MAXIMUM AVERAGE ON-STATE POWER DISSIPATION (SINGLE PHASE HALF WAVE)

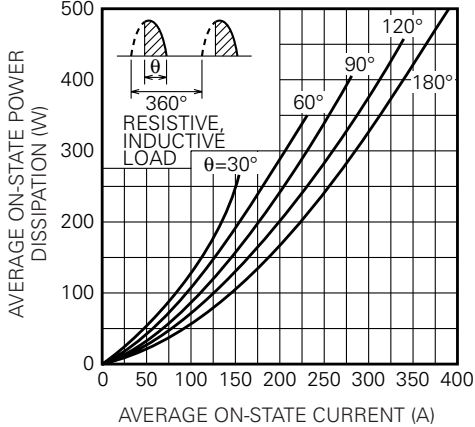

LIMITING VALUE OF THE AVERAGE ON-STATE CURRENT (SINGLE PHASE HALF WAVE)

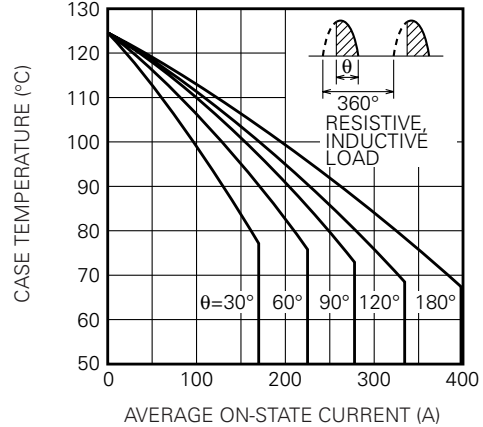

TM400HA-M,-H,-24,-2H

MEDIUM POWER GENERAL USE
INSULATED TYPE

