

MITSUBISHI THYRISTOR MODULES  
**TM130RZ/EZ/GZ-24,-2H**

HIGH VOLTAGE HIGH POWER GENERAL USE  
 INSULATED TYPE

TM130RZ/EZ/GZ-24,-2H



(RZ Type)

- **IT (AV)** Average on-state current ..... **130A**
- **IF (AV)** Average forward current ..... **130A**
- **VRRM** Repetitive peak reverse voltage  
..... **1200/1600V**
- **VDRM** Repetitive peak off-state voltage  
..... **1200/1600V**
- **MIX DOUBLE ARMS**
- **Insulated Type**
- **UL Recognized**

Yellow Card No. E80276 (N)  
 File No. E80271

**APPLICATION**

DC motor control, NC equipment, AC motor control, contactless switches,  
 electric furnace temperature control, light dimmers

**OUTLINE DRAWING & CIRCUIT DIAGRAM**

Dimensions in mm

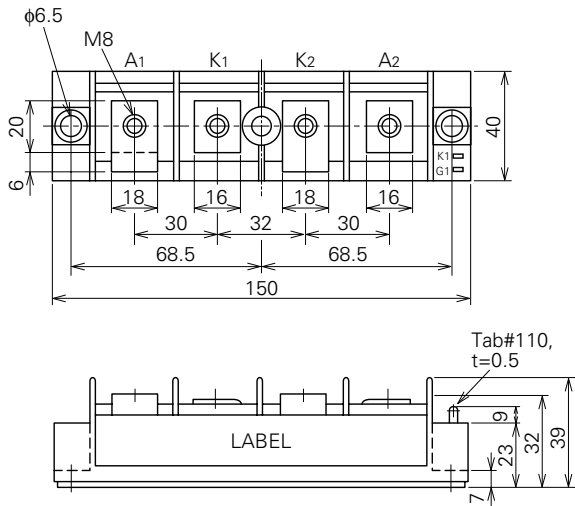

(RZ Type)

(RZ)

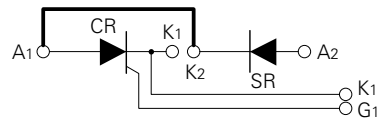

(EZ)

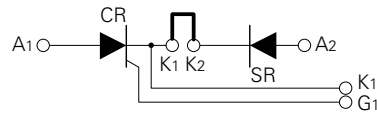

(GZ)

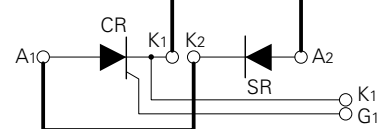

(Bold line is connective bar.)

# TM130RZ/EZ/GZ-24,-2H

HIGH VOLTAGE HIGH POWER GENERAL USE  
INSULATED TYPE

## ABSOLUTE MAXIMUM RATINGS

Symbol	Parameter	Voltage class		Unit
		24	2H	
VRRM	Repetitive peak reverse voltage	1200	1600	V
VRSM	Non-repetitive peak reverse voltage	1350	1700	V
VR (DC)	DC reverse voltage	960	1280	V
VDRM	Repetitive peak off-state voltage	1200	1600	V
VDSM	Non-repetitive peak off-state voltage	1350	1700	V
VD (DC)	DC off-state voltage	960	1280	V

Symbol	Parameter	Conditions	Ratings	Unit
$I_T$ (RMS), $I_F$ (RMS)	RMS current		205	A
$I_T$ (AV), $I_F$ (AV)	Average current	Single-phase, half-wave 180° conduction, $T_C=78^\circ\text{C}$	130	A
$I_{TSM}$ , $I_{FSM}$	Surge (non-repetitive) current	One half cycle at 60Hz, peak value	2600	A
$I^2t$	$I^2t$ for fusing	Value for one cycle of surge current	$2.8 \times 10^4$	$\text{A}^2\text{s}$
$di/dt$	Critical rate of rise of on-state current	$V_D=1/2V_{DRM}$ , $I_G=1.0\text{A}$ , $T_j=125^\circ\text{C}$	100	$\text{A}/\mu\text{s}$
PGM	Peak gate power dissipation		10	W
PG (AV)	Average gate power dissipation		3.0	W
VFGM	Peak gate forward voltage		10	V
VRGM	Peak gate reverse voltage		5.0	V
IFGM	Peak gate forward current		4.0	A
$T_j$	Junction temperature		-40~125	$^\circ\text{C}$
$T_{stg}$	Storage temperature		-40~125	$^\circ\text{C}$
$V_{iso}$	Isolation voltage	Charged part to case	2500	V
—	Mounting torque	Main terminal screw M8	8.83~10.8	N·m
			90~110	kg·cm
		Mounting screw M6	1.96~3.92	N·m
			20~40	kg·cm
—	Weight	Typical value	300	g

## ELECTRICAL CHARACTERISTICS

Symbol	Parameter	Test conditions	Limits			Unit
			Min.	Typ.	Max.	
IRRM	Repetitive peak reverse current	$T_j=125^\circ\text{C}$ , $V_{RRM}$ applied	—	—	30	mA
IDRM	Repetitive peak off-state current	$T_j=125^\circ\text{C}$ , $V_{DRM}$ applied	—	—	30	mA
$V_{TM}$ , $V_{FM}$	Forward voltage	$T_j=125^\circ\text{C}$ , $I_{TM}=I_{FM}=390\text{A}$ , instantaneous meas.	—	—	1.5	V
$dv/dt$	Critical rate of rise of off-state voltage	$T_j=125^\circ\text{C}$ , $V_D=2/3V_{DRM}$	500	—	—	$\text{V}/\mu\text{s}$
VGT	Gate trigger voltage	$T_j=25^\circ\text{C}$ , $V_D=6\text{V}$ , $R_L=2\Omega$	—	—	3.0	V
VGD	Gate non-trigger voltage	$T_j=125^\circ\text{C}$ , $V_D=1/2V_{DRM}$	0.25	—	—	V
IGT	Gate trigger current	$T_j=25^\circ\text{C}$ , $V_D=6\text{V}$ , $R_L=2\Omega$	15	—	100	mA
$R_{th(j-c)}$	Thermal resistance	Junction to case (per 1/2 module)	—	—	0.22	$^\circ\text{C}/\text{W}$
$R_{th(c-f)}$	Contact thermal resistance	Case to fin, conductive grease applied (per 1/2 module)	—	—	0.1	$^\circ\text{C}/\text{W}$
—	Insulation resistance	Measured with a 500V megohmmeter between main terminal and case	10	—	—	$\text{M}\Omega$

Note: Items of the above table applies to the Thyristor part and the Diode part as circled in the following tables.

# TM130RZ/EZ/GZ-24,-2H

HIGH VOLTAGE HIGH POWER GENERAL USE  
INSULATED TYPE

## MAXIMUM RATINGS

Item	VRRM	VRSM	VR (DC)	VDRM	VD SM	VD (DC)	IT (RMS)	IT (AV)	ITSM	$i^2t$	di/dt
							IF (RMS)	IF (AV)	IFSM		
Thyristor	○	○	○	○	○	○	○	○	○	○	○
Diode	○	○	○	—	—	—	○	○	○	○	—

Item	PGM	PG (AV)	VFGM	IFGM	T <sub>j</sub>	T <sub>stg</sub>
Thyristor	○	○	○	○	○	○
Diode	—	—	—	—	○	○

## ELECTRICAL CHARACTERISTICS

Item	IRRM	IDRM	VTM	dv/dt	VGT	VGD	IGT	Rth (j-c)	Rth (c-f)
			VFM						
Thyristor	○	○	○	○	○	○	○	○	○
Diode	○	—	○	—	—	—	—	○	○

## PERFORMANCE CURVES

MAXIMUM FORWARD CHARACTERISTIC

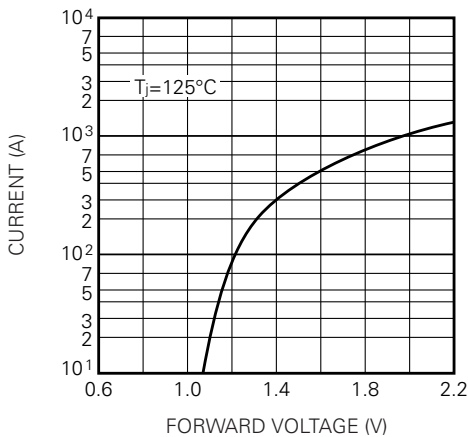

RATED SURGE (NON-REPETITIVE) CURRENT

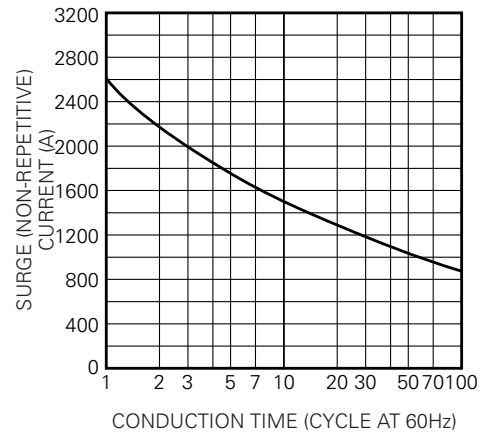

GATE CHARACTERISTICS

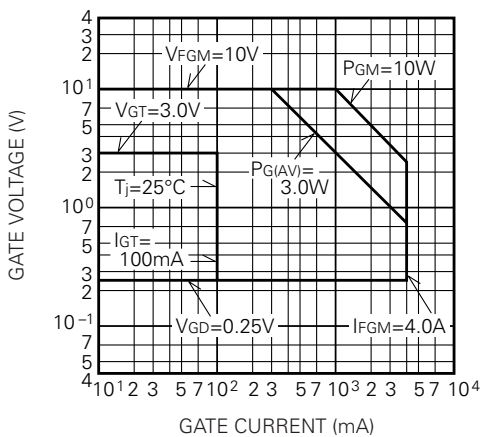

MAXIMUM TRANSIENT THERMAL IMPEDANCE (JUNCTION TO CASE)

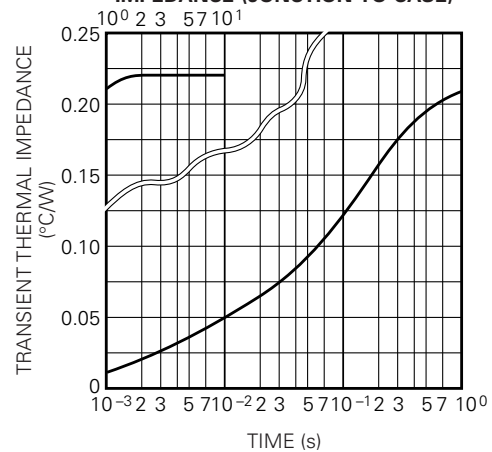

# TM130RZ/EZ/GZ-24,-2H

HIGH VOLTAGE HIGH POWER GENERAL USE  
INSULATED TYPE

**MAXIMUM AVERAGE POWER DISSIPATION (SINGLE PHASE HALF WAVE)**

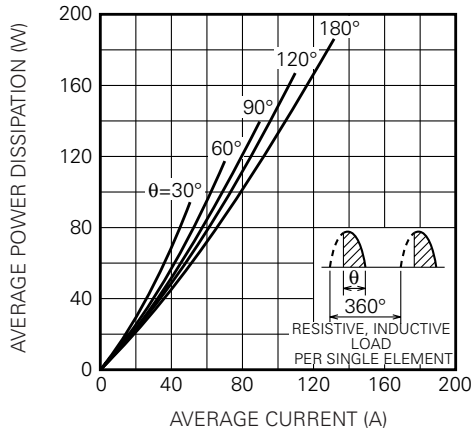

**LIMITING VALUE OF THE AVERAGE CURRENT (SINGLE PHASE HALF WAVE)**

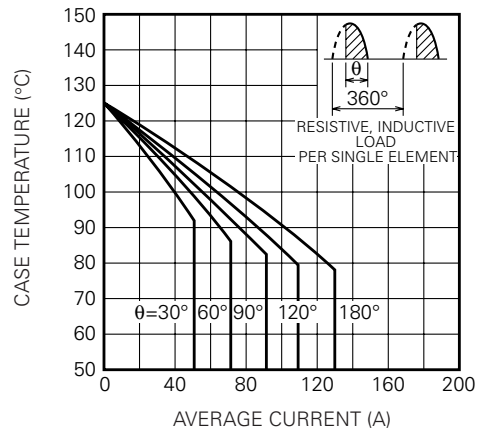

**MAXIMUM AVERAGE POWER DISSIPATION (RECTANGULAR WAVE)**

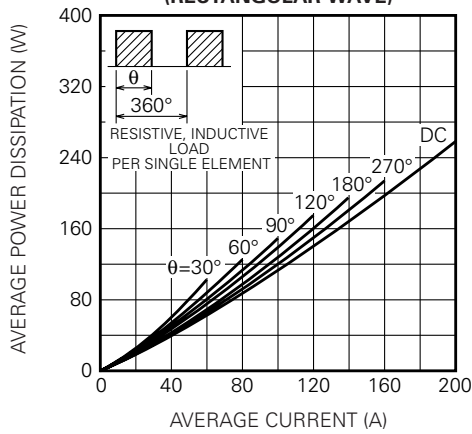

**LIMITING VALUE OF THE AVERAGE CURRENT (RECTANGULAR WAVE)**

