

TM100SZ-M

MEDIUM POWER GENERAL USE
NON-INSULATED TYPE

TM100SZ-M



- **IT (AV)** Average on-state current **100A**
- **VRRM** Repetitive peak reverse voltage
..... **400V**
- **VDRM** Repetitive peak off-state voltage
..... **400V**
- **TRIPLE ARMS**
- **Non-Insulated Type**

APPLICATION

Welders

OUTLINE DRAWING & CIRCUIT DIAGRAM

Dimensions in mm

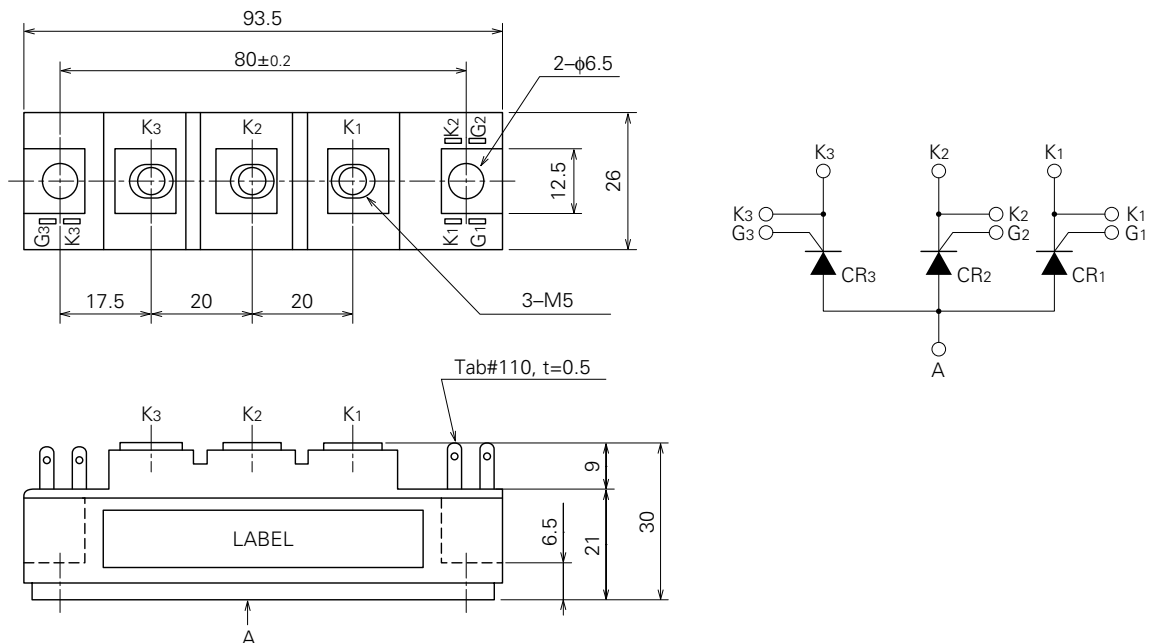

TM100SZ-M

MEDIUM POWER GENERAL USE

NON-INSULATED TYPE

ABSOLUTE MAXIMUM RATINGS

Symbol	Parameter	Voltage class		Unit
			M	
VRRM	Repetitive peak reverse voltage		400	V
VRSM	Non-repetitive peak reverse voltage		480	V
VR (DC)	DC reverse voltage		320	V
VDRM	Repetitive peak off-state voltage		400	V
VDSM	Non-repetitive peak off-state voltage		480	V
VD (DC)	DC off-state voltage		320	V

Symbol	Parameter	Conditions	Ratings	Unit
IT (RMS)	RMS on-state current		155	A
IT (AV)	Average on-state current	Three-phase, half-wave, Tc=122°C	100	A
ITSM	Surge (non-repetitive) on-state current	One half cycle at 60Hz, peak value	2000	A
I ² t	I ² t for fusing	Value for one cycle of surge current	1.7 × 10 ⁴	A ² s
di/dt	Critical rate of rise of on-state current	V _D =1/2V _{DRM} , I _G =1.0A, T _j =150°C	50	A/μs
PGM	Peak gate power dissipation		5.0	W
PG (AV)	Average gate power dissipation		0.5	W
VFGM	Peak gate forward voltage		10	V
VRGM	Peak gate reverse voltage		5.0	V
IFGM	Peak gate forward current		2.0	A
T _j	Junction temperature		-40~+150	°C
T _{stg}	Storage temperature		-40~+125	°C
—	Mounting torque	Main terminal screw M5	1.47~1.96	N·m
			15~20	kg·cm
		Mounting screw M6	1.96~2.94	N·m
			20~30	kg·cm
—	Weight	Typical value	160	g

ELECTRICAL CHARACTERISTICS

Symbol	Parameter	Test conditions	Limits			Unit
			Min.	Typ.	Max.	
IRRM	Repetitive peak reverse current	T _j =150°C, VRRM applied	—	—	30	mA
IDRM	Repetitive peak off-state current	T _j =150°C, VDRM applied	—	—	30	mA
VTM	On-state voltage	T _j =150°C, I _{TM} =300A, instantaneous meas.	—	—	1.15	V
dv/dt	Critical rate of rise of off-state voltage	T _j =150°C, V _D =2/3V _{DRM}	200	—	—	V/μs
VGT	Gate trigger voltage	T _j =25°C, V _D =6V, R _L =2Ω	—	—	3.0	V
VGD	Gate non-trigger voltage	T _j =150°C, V _D =1/2V _{DRM}	0.25	—	—	V
IGT	Gate trigger current	T _j =25°C, V _D =6V, R _L =2Ω	15	—	100	mA
R _{th (j-c)}	Thermal resistance	Junction to case (per 1/3 module)	—	—	0.2	°C/W
R _{th (c-f)}	Contact thermal resistance	Case to fin, conductive grease applied (per 1/3 module)	—	—	0.3	°C/W

TM100SZ-M

MEDIUM POWER GENERAL USE
NON-INSULATED TYPE

PERFORMANCE CURVES

MAXIMUM ON-STATE CHARACTERISTIC

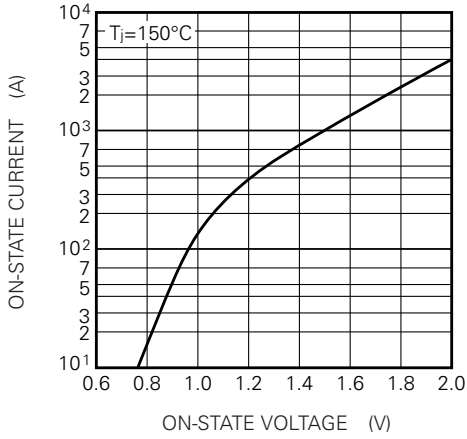

RATED SURGE (NON-REPETITIVE) ON-STATE CURRENT

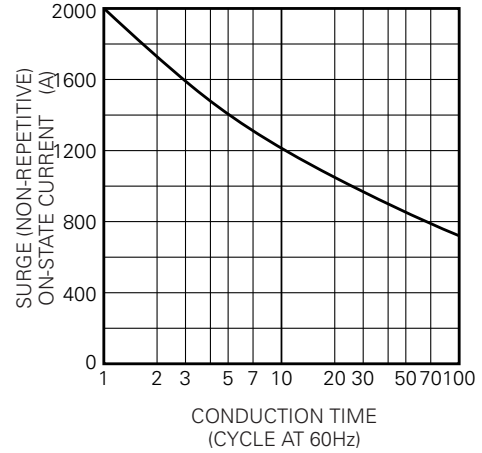

GATE CHARACTERISTICS

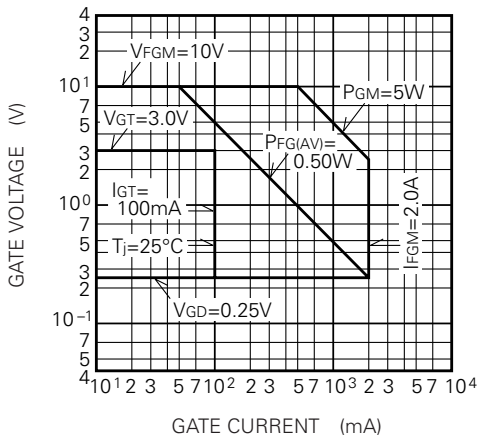

MAXIMUM TRANSIENT THERMAL IMPEDANCE (JUNCTION TO CASE)

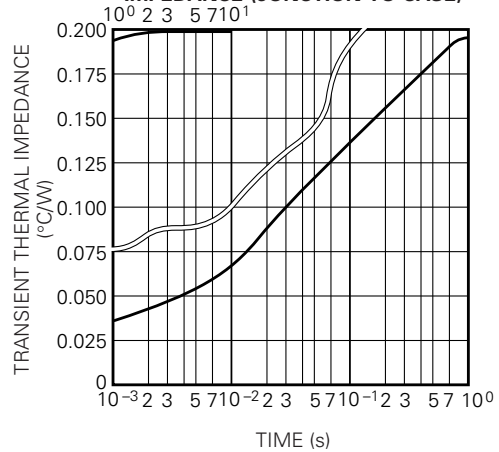

MAXIMUM AVERAGE ON-STATE POWER DISSIPATION (SINGLE PHASE HALFWAVE)

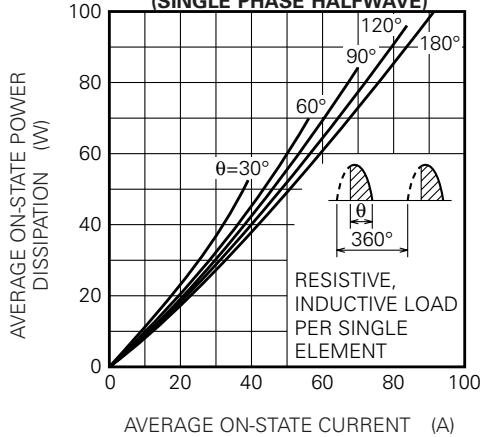

LIMITING VALUE OF THE AVERAGE ON-STATE CURRENT (SINGLE PHASE HALFWAVE)

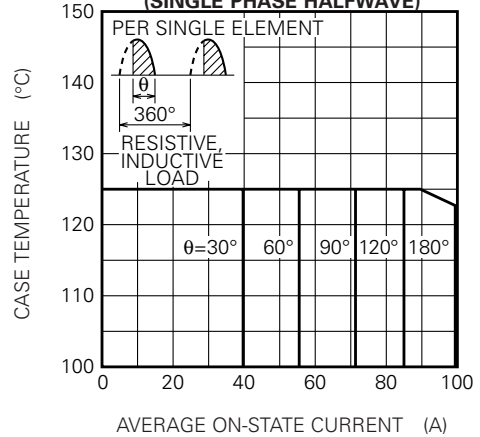

TM100SZ-M

MEDIUM POWER GENERAL USE
NON-INSULATED TYPE

