

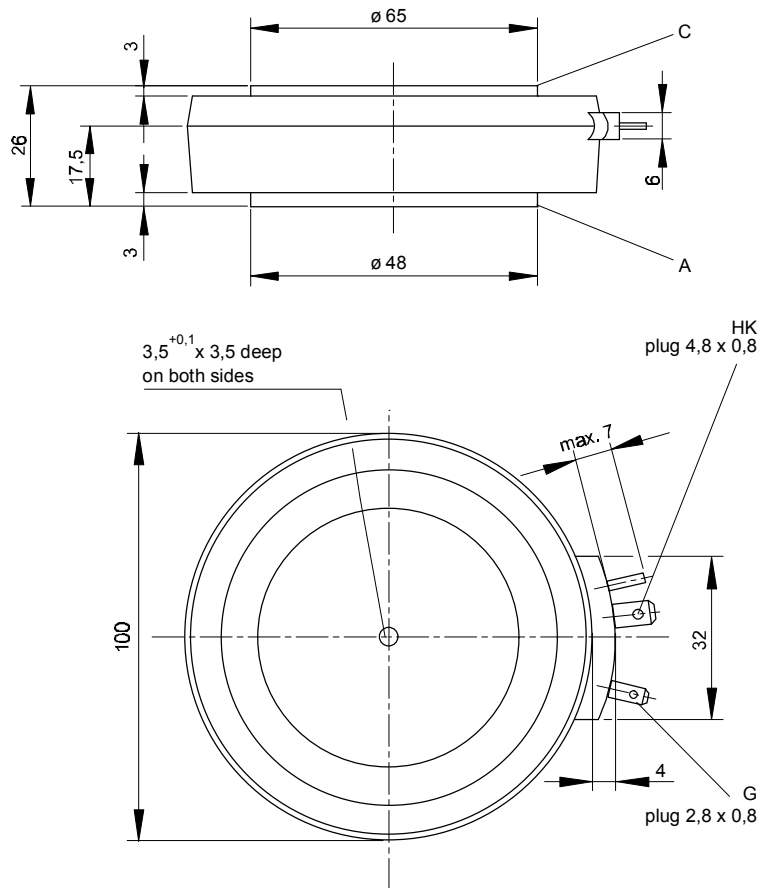

European Power-Semiconductor and Electronics Company

Marketing Information T 1989 N



T 1989 N

Elektrische Eigenschaften

Höchstzulässige Werte

Periodische Vorwärts- und Rückwärts-

Stromsperrspannung

Vorwärts-Stoßsperrspannung

Rückwärts-Stoßsperrspannung

Durchlaßstrom-Grenzeffektivwert

Dauergrenzstrom

Stoßstrom-Grenzwert

Grenzlastintegral

Kritische Stromsteilheit

Kritische Spannungssteilheit

Charakteristische Werte

Durchlaßspannung

Schleusenspannung

Ersatzwiderstand

Zündstrom

Zündspannung

Nicht zündender Steuerstrom

Nicht zündende Steuerspannung

Haltestrom

Einraststrom

Vorwärts- und Rückwärts-Sperrstrom

Zündverzögerung

Freierdezeit

Thermische Eigenschaften

Innerer Wärmewiderstand

Übergangs-Wärmewiderstand

Höchstzul. Sperrschichttemperatur

Betriebstemperatur

Lagertemperatur

Mechanische Eigenschaften

Si-Element mit Druckkontakt, Amplifying-

Gate

Anpreßkraft

Gewicht

Kriechstrecke

Feuchteklasse

Schwingfestigkeit

Gehäuse

Electrical properties

Maximum rated values

repetitive peak forward off-state and

reverse voltages

non-repetitive peak forward off-state

voltage

non-repetitive peak reverse voltage

RMS on-state current

average on-state current

surge current

I²t-value

critical rate of rise of on-state current

critical rate of rise of off-state voltage

Characteristic values

on-state voltage

threshold voltage

slope resistance

gate trigger current

gate trigger voltage

gate non-trigger current

gate non-trigger voltage

holding current

latching current

forward off-state and reverse currents

gate controlled delay time

circuit commutated turn-off time

Thermal properties

thermal resistance, junction to case

thermal resistance, case to heatsink

max. junction temperature

operating temperature

storage temperature

Mechanical properties

Si-pellet with pressure contact, amplifying

gate

clamping force

weight

creepage distance

humidity classification

vibration resistance

case

$t_{vj} = -40^{\circ}\text{C} \dots t_{vj\text{max}}$

$t_{vj} = -40^{\circ}\text{C} \dots t_{vj\text{max}}$

$t_{vj} = +25^{\circ}\text{C} \dots t_{vj\text{max}}$

$t_c = 85^{\circ}\text{C}$

$t_c = 65^{\circ}\text{C}$

$t_{vj} = 25^{\circ}\text{C}, t_p = 10 \text{ ms}$

$t_{vj} = t_{vj\text{max}}, t_p = 10 \text{ ms}$

$t_{vj} = 25^{\circ}\text{C}, t_p = 10 \text{ ms}$

$t_{vj} = t_{vj\text{max}}, t_p = 10 \text{ ms}$

DIN IEC 747-6, f = 50 Hz,

$v_L = 10 \text{ V}, i_{GM} = 1 \text{ A}, di_G/dt = 1 \text{ A}/\mu\text{s}$

$t_{vj} = t_{vj\text{max}}, v_D = 0,67 V_{DRM}$

5.Kennbuchstabe/5th letter C

5.Kennbuchstabe/5th letter F

$t_{vj} = t_{vj\text{max}}, i_T = 8000 \text{ A}$

$t_{vj} = t_{vj\text{max}}$

$t_{vj} = t_{vj\text{max}}$

$t_{vj} = 25^{\circ}\text{C}, v_D = 6 \text{ V}$

$t_{vj} = 25^{\circ}\text{C}, v_D = 6 \text{ V}$

$t_{vj} = t_{vj\text{max}}, v_D = 6 \text{ V}$

$t_{vj} = t_{vj\text{max}}, v_D = 0,5 V_{DRM}$

$t_{vj} = t_{vj\text{max}}, v_D = 0,5 V_{DRM}$

$t_{vj} = 25^{\circ}\text{C}, v_D = 6 \text{ V}, R_A = 5 \Omega$

$t_{vj} = 25^{\circ}\text{C}, v_D = 6 \text{ V}, R_{GK} \geq 10 \Omega$

$i_{GM} = 1 \text{ A}, di_G/dt = 1 \text{ A}/\mu\text{s}, t_g = 20 \mu\text{s}$

$t_{vj} = t_{vj\text{max}}, v_D = V_{DRM}, v_R = V_{RRM}$

DIN IEC 747-6, $t_{vj} = 25^{\circ}\text{C}, i_{GM} = 1 \text{ A},$

$di_G/dt = 1 \text{ A}/\mu\text{s}$

$t_{vj} = t_{vj\text{max}}, I_{TM} = I_{TAVM}, V_{RM} = 100 \text{ V}, V_{DM} = 0,67 t_{vj}$

$v_{DRM}, dv_D/dt = 20 \text{ V}/\mu\text{s}, -di_T/dt = 10 \text{ A}/\mu\text{s},$

4.Kennbuchstabe/4th letter O

V_{DRM}, V_{RRM}

V_{DSM}

V_{RSM}

I_{TRMSM}

I_{TAVM}

I_{TSM}

$I^2 t$

$(di_T/dt)_{cr}$

$(dv_D/dt)_{cr}$

v_T

$V_{T(TO)}$

r_T

I_{GT}

V_{GT}

I_{GD}

V_{GD}

I_H

I_L

i_D, i_R

t_{gd}

R_{thJC}

R_{thCK}

$t_{vj\text{max}}$

$t_{c\text{op}}$

t_{stg}

F

G

DIN 40040

f = 50 Hz

Titelseite / front page

1200 1400 1600 V¹⁾

1800 V

1300 1500 1700 V

1900 A

1990 A

2675 A

40000 A¹⁾

36000 A

8 · 10⁶ A²s

6,48 · 10⁶ A²s

200 A/μs

500 V/μs

1000 V/μs

max. 2,053 V

0,90 V

0,120 mΩ

max. 250 mA

max. 2 V

max. 10 mA

max. 5 mA

max. 0,25 V

max. 300 mA

max. 1500 mA

max. 250 mA

max. 4 μs

typ. 250 μs

max. 0,0133 °C/W

max. 0,0125 °C/W

max. 0,0030 °C/W

max. 0,0060 °C/W

125 °C

-40...+125 °C

-40...+150 °C

30...65 kN

typ. 900 g

30 mm

C

50 m/s²

¹⁾ Gehäusegrenzstrom 36 kA (50Hz Sinushalbwellen). / Current limit of case 36 kA (50Hz sinusoidal half-wave).

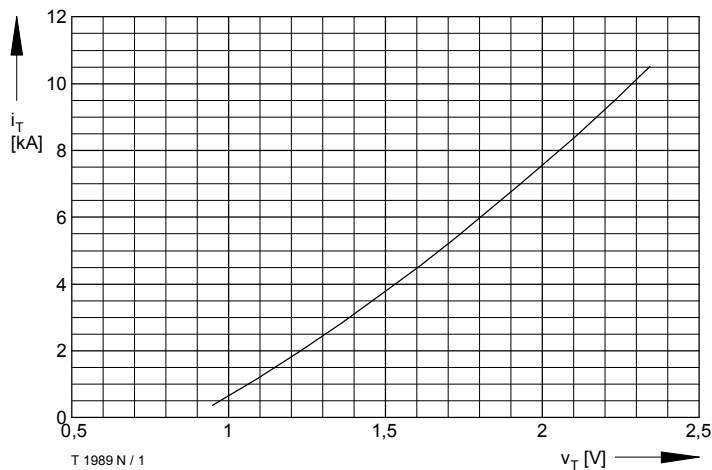

T 1989 N / 1

Bild / Fig. 1
Grenzdurchlaßkennlinie / Limiting on-state characteristic $i_T = f(v_T)$
 $t_{vj} = t_{vj \max}$

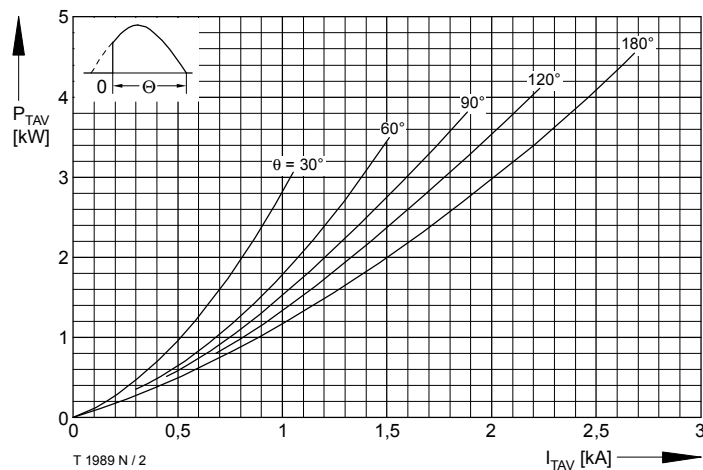

T 1989 N / 2

Bild / Fig. 2
Durchlaßverlustleistung / On-state power loss $P_{TAV} = f(I_{TAV})$
Parameter: Stromflußwinkel / Current conduction angle θ

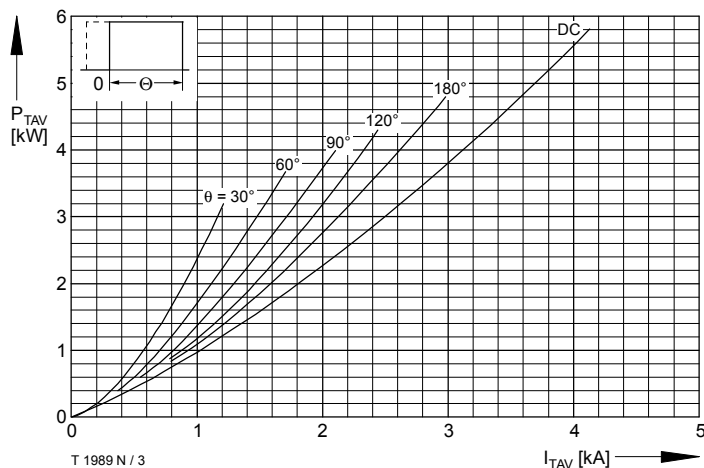

T 1989 N / 3

Bild / Fig. 3
Durchlaßverlustleistung / On-state power loss $P_{TAV} = f(I_{TAV})$
Parameter: Stromflußwinkel / Current conduction angle θ

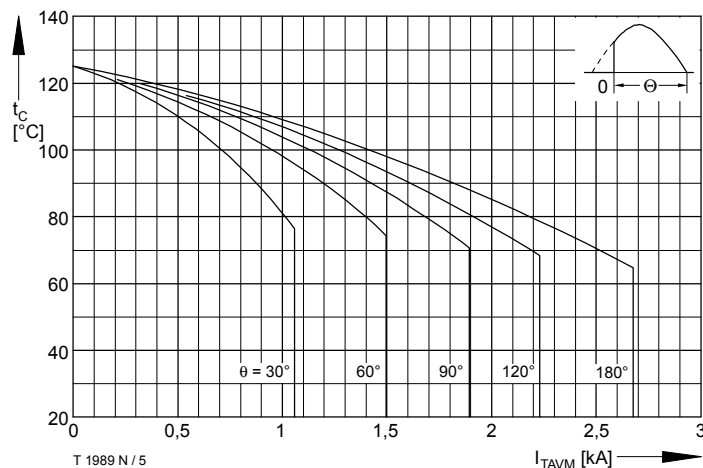

T 1989 N / 5

Bild / Fig. 5
Höchstzulässige Gehäusetemperatur / Maximum allowable case temperature $t_c = f(I_{TAVM})$
Beidseitige Kühlung / Two sided cooling
Parameter: Stromflußwinkel / current conduction angle θ
Berechnungsgrundlage P_{TAV} (Schaltverluste gesondert berücksichtigen) / Calculation base P_{TAV} (switching losses should be considered separately)

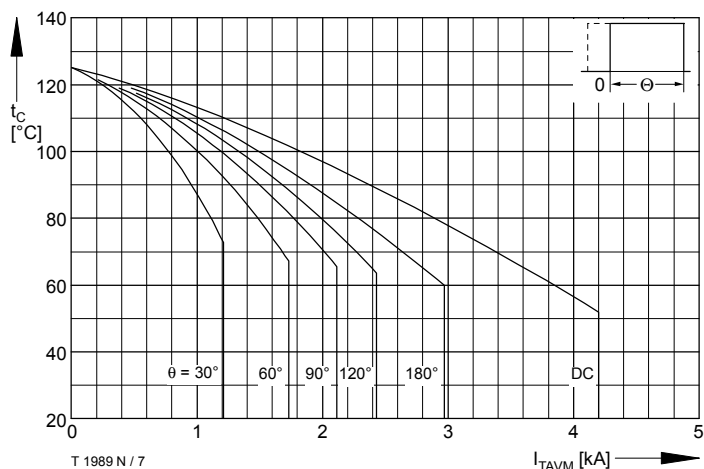

T 1989 N / 7

Bild / Fig. 7
Höchstzulässige Gehäusetemperatur / Maximum allowable case temperature $t_c = f(I_{TAVM})$
Beidseitige Kühlung / Two sided cooling
Parameter: Stromflußwinkel / current conduction angle θ

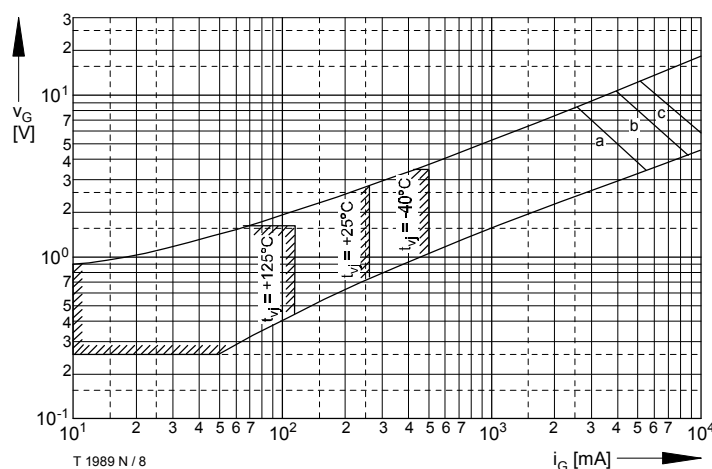

T 1989 N / 8

Bild / Fig. 8
Steuercharakteristik mit Zündbereichen / Gate characteristic with triggering areas $v_G = f(i_G)$, $V_D = 6 \text{ V}$
Parameter:

	a	b	c
Steuerimpulsdauer / Puls duration t_G [ms]	10	1	0.5
Höchstzulässige Spitzensteuerleistung / Maximum allowable peak gate power [W]	20	40	60



Bild / Fig. 9
 Zündverzögerung / Gate controlled delay time $t_{gd} = f(i_{GM})$, $t_{vj} = 25^\circ\text{C}$,
 $di_G/dt = i_{GM}/1\mu\text{s}$
 a - Maximaler Verlauf / Limiting characteristic
 b - Typischer Verlauf / Typical characteristic



Bild / Fig. 10
 Sperrverzögerungsladung / Recovered charge $Q_r = f(di/dt)$
 $t_{vj} = t_{vj\text{ max}}$, $V_R \leq 0,5 V_{RRM}$, $V_{RM} = 0,8 V_{RRM}$
 Parameter: Durchlaßstrom / On-state current i_{TM}

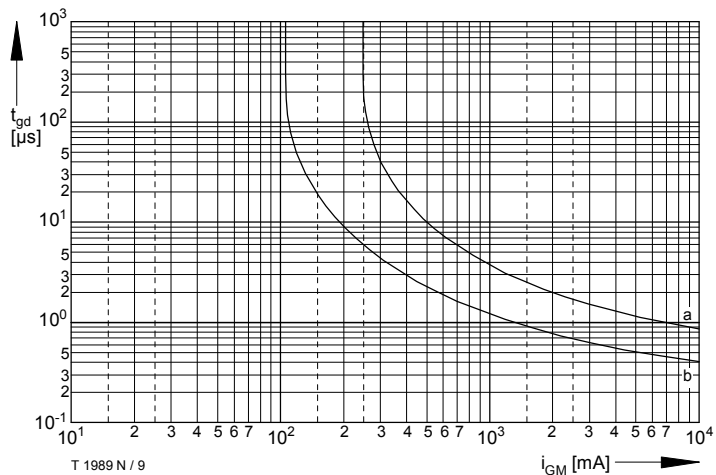

Bild / Fig. 11
 Transienter innerer Wärmewiderstand / Transient thermal impedance
 $Z_{thJC} = f(t)$
 Beidseitige Kühlung / Two-sided cooling
 Parameter: Stromflußwinkel / Current conduction angle θ

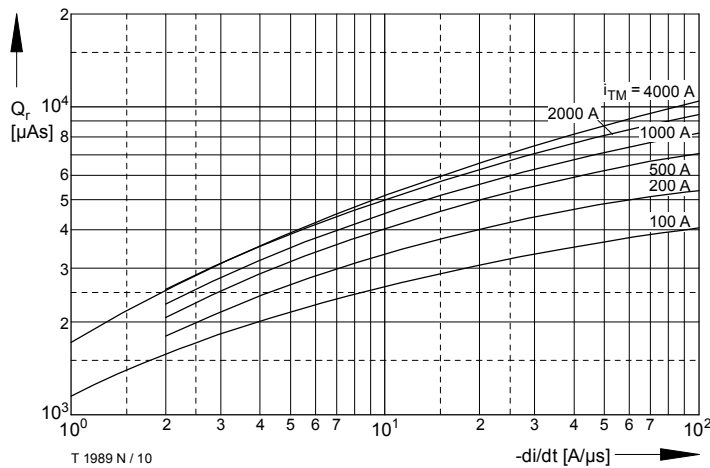

Bild / Fig. 12
 Transienter innerer Wärmewiderstand / Transient thermal impedance
 $Z_{thJC} = f(t)$
 Beidseitige Kühlung / Two-sided cooling
 Parameter: Stromflußwinkel / Current conduction angle θ

Analytische Elemente des transienten Wärmewiderstandes Z_{thJC} pro Zweig für DC
 Analytical elements of transient thermal impedance Z_{thJC} per arm for DC

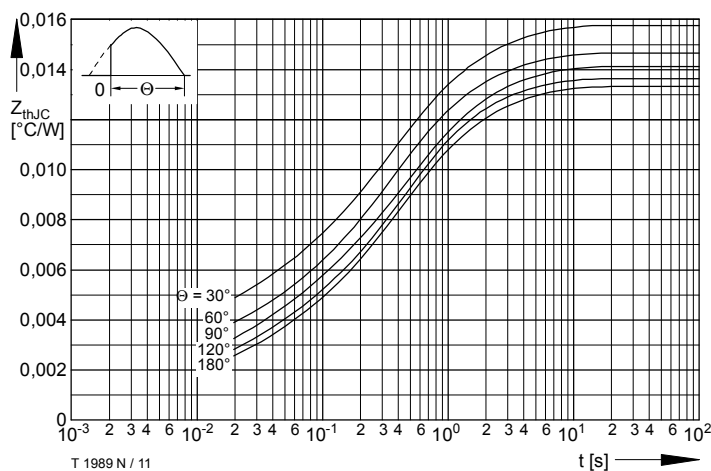
Beidseitige Kühlung / Two-sided cooling

Pos. n	1	2	3	4	5	6
$R_{thn} [^\circ\text{C}/\text{W}]$	0,000036	0,0006	0,00097	0,002917	0,00456	0,0034
$\tau_n [\text{s}]$	0,000287	0,00298	0,0135	0,134	0,449	2,05

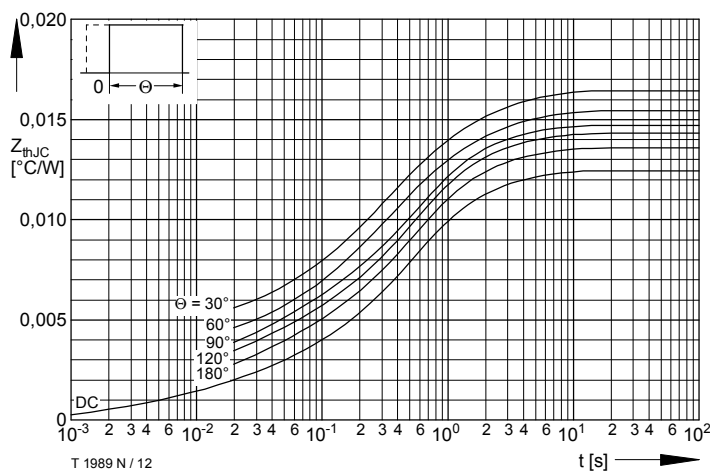
Analytische Funktion / Analytical function:

$$Z_{thJC} = \sum_{n=1}^{n_{\text{max}}} R_{thn} (1 - e^{-\frac{t}{\tau_n}})$$

Terms & Conditions of Usage

Attention

The present product data is exclusively subscribed to technically experienced staff. This Data Sheet is describing the specification of the products for which a warranty is granted exclusively pursuant the terms and conditions of the supply agreement. There will be no guarantee of any kind for the product and its specifications. Changes to the Data Sheet are reserved.

You and your technical departments will have to evaluate the suitability of the product for the intended application and the completeness of the product data with respect to such application. Should you require product information in excess of the data given in the Data Sheet, please contact your local Sales Office via "www.eupec.com / sales & contact".

Warning

Due to technical requirements the products may contain dangerous substances. For information on the types in question please contact your local Sales Office via "www.eupec.com / sales & contact".