

Turbo 2 ultrafast high voltage rectifier

Main product characteristics

$I_{F(AV)}$	2 x 40 A
V_{RRM}	600 V
T_j	150° C
V_F (typ)	1.30 V
t_{rr} (typ)	50 ns

Features and benefits

- Ultrafast switching
- Low reverse current
- Low thermal resistance
- Reduces switching & conduction losses
- Insulated package:
Electrical insulation = 2500 V_{RMS}
Capacitance = 45 pF

Description

The STTH60L06TV, which is using ST Turbo 2 600V technology, is specially suited for use in switching power supplies, and industrial applications (such as welding), as rectification diode.

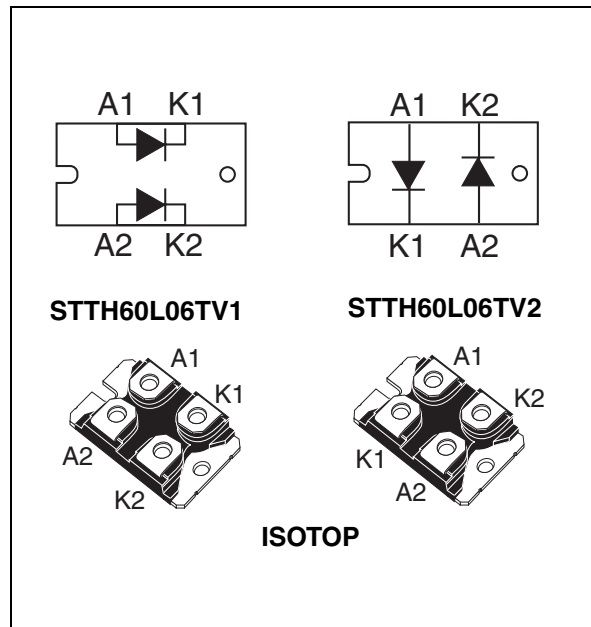

Order codes

Part Number	Marking
STTH60L06TV1	STTH60L06TV1
STTH60L06TV2	STTH60L06TV2

Table 1. Absolute ratings (limiting values per diode at 25° C, unless otherwise specified)

Symbol	Parameter	Value	Unit	
V_{RRM}	Repetitive peak reverse voltage	600	V	
$I_{F(RMS)}$	RMS forward current	100	A	
$I_{F(AV)}$	Average forward current, $\delta = 0.5$	$T_c = 75^\circ \text{C}$ per diode	30	A
		$T_c = 70^\circ \text{C}$ per diode	40	
I_{FSM}	Surge non repetitive forward current	$t_p = 10 \text{ ms}$ Sinusoidal	210	A
T_{stg}	Storage temperature range	-55 to + 150	° C	
T_j	Maximum operating junction temperature	150	° C	

1 Characteristics

Table 2. Thermal parameters

Symbol	Parameter		Value	Unit
$R_{th(j-c)}$	Junction to case	Per diode	1.60	°C/W
		Total	0.85	
$R_{th(c)}$	Coupling thermal resistance		0.1	

When the diodes are used simultaneously:

$$\Delta T_{j(diode1)} = P_{(diode1)} \times R_{th(j-c)} \text{ (per diode)} + P_{(diode2)} \times R_{th(c)}$$

Table 3. Static electrical characteristics (per diode)

Symbol	Parameter	Test conditions		Min.	Typ	Max.	Unit
$I_R^{(1)}$	Reverse leakage current	$T_j = 25^\circ \text{C}$	$V_R = V_{RRM}$			25	μA
		$T_j = 125^\circ \text{C}$			25	250	
$V_F^{(2)}$	Forward voltage drop	$T_j = 25^\circ \text{C}$	$I_F = 60 \text{ A}$			1.55	V
		$T_j = 150^\circ \text{C}$			1.0	1.25	

1. Pulse test: $t_p = 5 \text{ ms}$, $\delta < 2 \%$

2. Pulse test: $t_p = 380 \mu\text{s}$, $\delta < 2 \%$

To evaluate the conduction losses use the following equation:

$$P = 0.95 \times I_{F(AV)} + 0.010 I_{F(RMS)}^2$$

Table 4. Dynamic characteristics (per diode)

Symbol	Parameter	Test conditions	Min.	Typ	Max.	Unit
t_{rr}	Reverse recovery time	$I_F = 0.5 \text{ A}$, $I_{rr} = 0.25 \text{ A}$ $I_R = 1 \text{ A}$, $T_j = 25^\circ \text{C}$			65	ns
		$I_F = 1 \text{ A}$, $di_F/dt = 50 \text{ A}/\mu\text{s}$, $V_R = 30 \text{ V}$, $T_j = 25^\circ \text{C}$		65	90	
I_{RM}	Reverse recovery current	$I_F = 30 \text{ A}$, $di_F/dt = 100 \text{ A}/\mu\text{s}$, $V_R = 400 \text{ V}$, $T_j = 125^\circ \text{C}$		11.5	16	A
t_{fr}	Forward recovery time	$I_F = 30 \text{ A}$ $di_F/dt = 100 \text{ A}/\mu\text{s}$ $V_{FR} = 1.1 \times V_{Fmax}$, $T_j = 25^\circ \text{C}$			500	ns
V_{FP}	Forward recovery voltage	$I_F = 30 \text{ A}$, $di_F/dt = 100 \text{ A}/\mu\text{s}$, $V_{FR} = 1.1 \times V_{Fmax}$, $T_j = 25^\circ \text{C}$		2.5		V

Figure 1. Conduction losses versus average current (per diode)

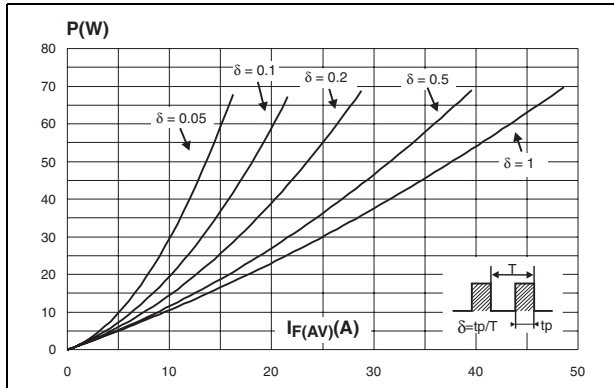

Figure 2. Forward voltage drop versus forward current (per diode)

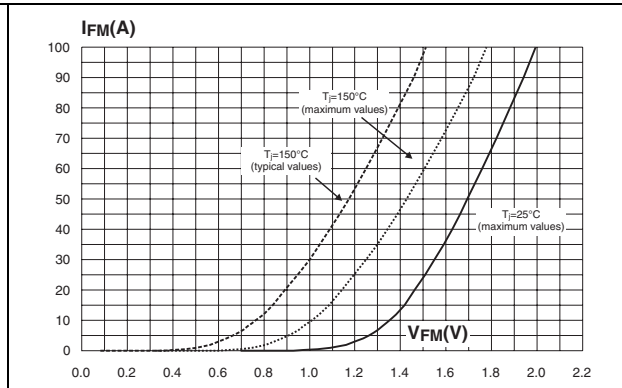

Figure 3. Relative variation of thermal impedance junction to case versus pulse duration

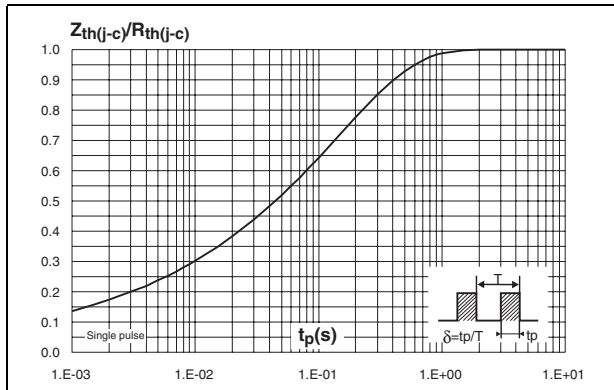

Figure 4. Peak reverse recovery current versus di/dt (typical values, per diode)

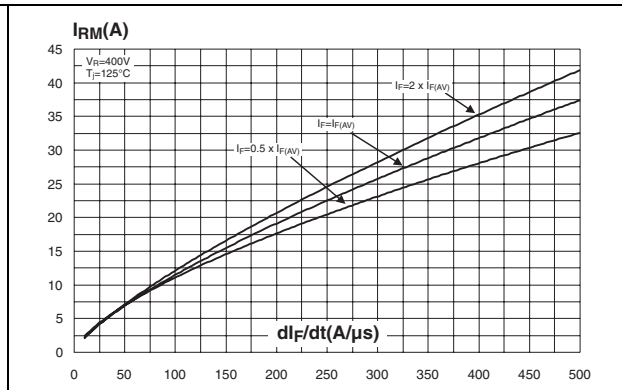

Figure 5. Reverse recovery time versus di/dt (typical values, per diode)

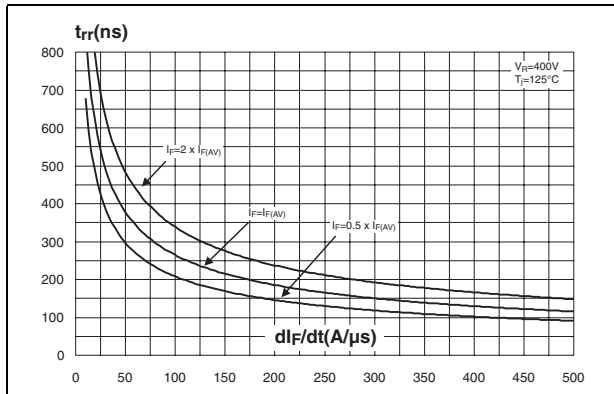

Figure 6. Reverse recovery charges versus di/dt (typical values, per diode)

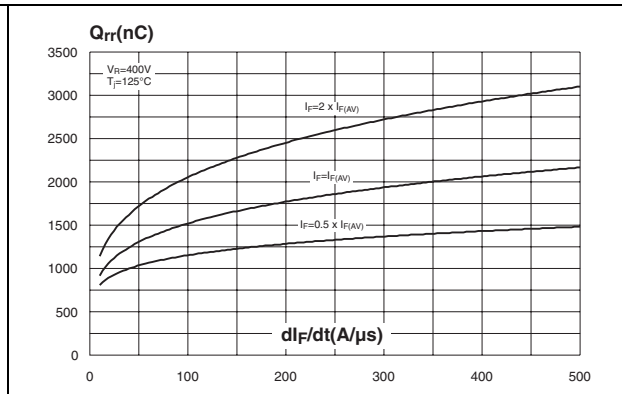

Figure 7. Reverse recovery softness factor versus di_F/dt (typical values, per diode)

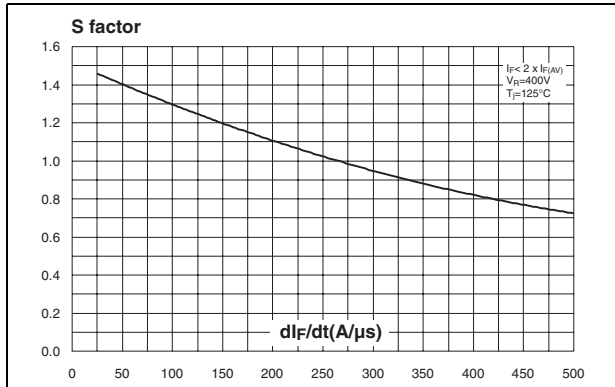

Figure 8. Relative variations of dynamic parameters versus junction temperature

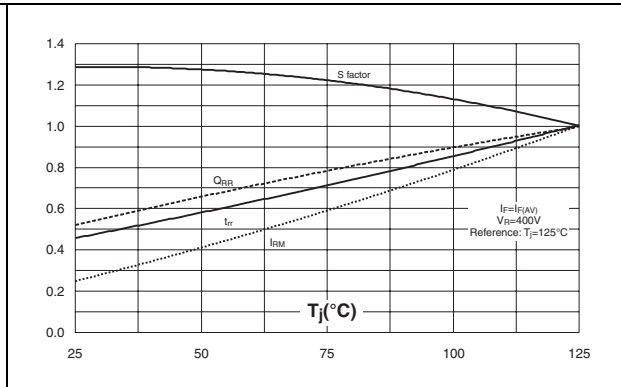

Figure 9. Transient peak forward voltage versus di_F/dt (typical values, per diode)

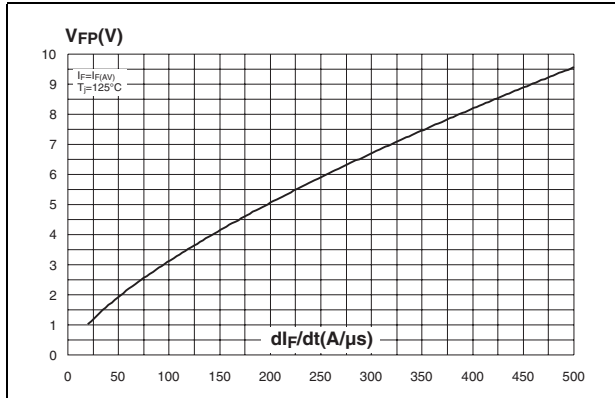

Figure 10. Forward recovery time versus di_F/dt (typical values, per diode)

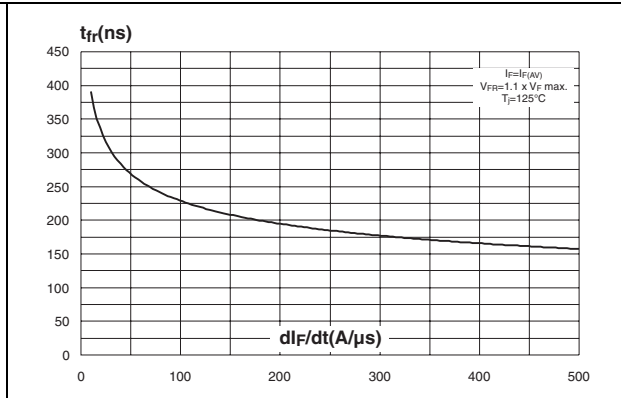
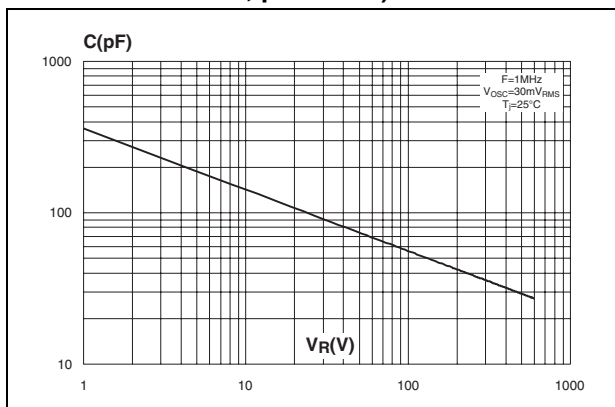

Figure 11. Junction capacitance versus reverse voltage applied (typical values, per diode)



2 Package mechanical data

Epoxy meets UL94, V0

Cooling method: by conduction (C)

Table 5. ISOTOP dimensions

REF.	DIMENSIONS			
	Millimeters		Inches	
	Min.	Max.	Min.	Max.
A	11.80	12.20	0.465	0.480
A1	8.90	9.10	0.350	0.358
B	7.8	8.20	0.307	0.323
C	0.75	0.85	0.030	0.033
C2	1.95	2.05	0.077	0.081
D	37.80	38.20	1.488	1.504
D1	31.50	31.70	1.240	1.248
E	25.15	25.50	0.990	1.004
E1	23.85	24.15	0.939	0.951
E2	24.80 typ.		0.976 typ.	
G	14.90	15.10	0.587	0.594
G1	12.60	12.80	0.496	0.504
G2	3.50	4.30	0.138	0.169
F	4.10	4.30	0.161	0.169
F1	4.60	5.00	0.181	0.197
P	4.00	4.30	0.157	0.69
P1	4.00	4.40	0.157	0.173
S	30.10	30.30	1.185	1.193

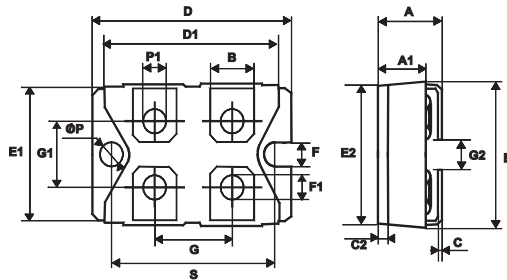

In order to meet environmental requirements, ST offers these devices in ECOPACK® packages. These packages have a Lead-free second level interconnect . The category of second level interconnect is marked on the package and on the inner box label, in compliance with JEDEC Standard JESD97. The maximum ratings related to soldering conditions are also marked on the inner box label. ECOPACK is an ST trademark. ECOPACK specifications are available at: www.st.com.

3 Ordering information

Part Number	Marking	Package	Weight	Base qty	Delivery mode
STTH60L06TV1	STTH60L06TV1	ISOTOP	27 g (without screws)	10 (with screws)	Tube
STTH60L06TV2	STTH60L06TV2	ISOTOP	27 g (without screws)	10 (with screws)	Tube

4 Revision history

Date	Revision	Description of Changes
07-Sep-2004	1	First issue
10-Sep-2004	2	Average forward current (page 1) and Junction to case (page 2) values changed
13-Oct-2006	3	Reformatted to current standard. Added part number STTH60L06TV2.

Please Read Carefully:

Information in this document is provided solely in connection with ST products. STMicroelectronics NV and its subsidiaries ("ST") reserve the right to make changes, corrections, modifications or improvements, to this document, and the products and services described herein at any time, without notice.

All ST products are sold pursuant to ST's terms and conditions of sale.

Purchasers are solely responsible for the choice, selection and use of the ST products and services described herein, and ST assumes no liability whatsoever relating to the choice, selection or use of the ST products and services described herein.

No license, express or implied, by estoppel or otherwise, to any intellectual property rights is granted under this document. If any part of this document refers to any third party products or services it shall not be deemed a license grant by ST for the use of such third party products or services, or any intellectual property contained therein or considered as a warranty covering the use in any manner whatsoever of such third party products or services or any intellectual property contained therein.

UNLESS OTHERWISE SET FORTH IN ST'S TERMS AND CONDITIONS OF SALE ST DISCLAIMS ANY EXPRESS OR IMPLIED WARRANTY WITH RESPECT TO THE USE AND/OR SALE OF ST PRODUCTS INCLUDING WITHOUT LIMITATION IMPLIED WARRANTIES OF MERCHANTABILITY, FITNESS FOR A PARTICULAR PURPOSE (AND THEIR EQUIVALENTS UNDER THE LAWS OF ANY JURISDICTION), OR INFRINGEMENT OF ANY PATENT, COPYRIGHT OR OTHER INTELLECTUAL PROPERTY RIGHT.

UNLESS EXPRESSLY APPROVED IN WRITING BY AN AUTHORIZED ST REPRESENTATIVE, ST PRODUCTS ARE NOT RECOMMENDED, AUTHORIZED OR WARRANTED FOR USE IN MILITARY, AIR CRAFT, SPACE, LIFE SAVING, OR LIFE SUSTAINING APPLICATIONS, NOR IN PRODUCTS OR SYSTEMS WHERE FAILURE OR MALFUNCTION MAY RESULT IN PERSONAL INJURY, DEATH, OR SEVERE PROPERTY OR ENVIRONMENTAL DAMAGE. ST PRODUCTS WHICH ARE NOT SPECIFIED AS "AUTOMOTIVE GRADE" MAY ONLY BE USED IN AUTOMOTIVE APPLICATIONS AT USER'S OWN RISK.

Resale of ST products with provisions different from the statements and/or technical features set forth in this document shall immediately void any warranty granted by ST for the ST product or service described herein and shall not create or extend in any manner whatsoever, any liability of ST.

ST and the ST logo are trademarks or registered trademarks of ST in various countries.

Information in this document supersedes and replaces all information previously supplied.

The ST logo is a registered trademark of STMicroelectronics. All other names are the property of their respective owners.

© 2006 STMicroelectronics - All rights reserved

STMicroelectronics group of companies

Australia - Belgium - Brazil - Canada - China - Czech Republic - Finland - France - Germany - Hong Kong - India - Israel - Italy - Japan - Malaysia - Malta - Morocco - Singapore - Spain - Sweden - Switzerland - United Kingdom - United States of America

www.st.com