

Absolute Maximum Ratings		Values	Units
Symbol	Conditions ¹⁾		
V _{CES}		1200	V
V _{CGR}	R _{GE} = 20 kΩ	1200	V
I _C	T _{case} = 25/80 °C	500 / 420	A
I _{CM}	T _{case} = 25/80 °C; t _p = 1 ms	1000 / 840	A
V _{GES}		± 20	V
P _{tot}	per IGBT, T _{case} = 25 °C	3000	W
T _j , (T _{stg})		- 40 ... +150 (125)	°C
V _{isol}	AC, 1 min.	2 500 ⁷⁾	V
humidity	DIN 40 040	Class F	
climate	DIN IEC 68 T.1	40/125/56	
Inverse Diode			
I _F = - I _C	T _{case} = 25/80 °C	500 / 350	A
I _{FM} = - I _{CM}	T _{case} = 25/80 °C; t _p = 1 ms	1000 / 840	A
I _{FSM}	t _p = 10 ms; sin.; T _j = 150 °C	3600	A
I ² t	t _p = 10 ms; T _j = 150 °C	64800	A ² s

Characteristics		min.	typ.	max.	Units
Symbol	Conditions ¹⁾				
V _{(BR)CES}	V _{GE} = 0, I _C = 6 mA	≥ V _{CES}	-	-	V
V _{GE(th)}	V _{GE} = V _{CE} , I _C = 16 mA	4,5	5,5	6,5	V
I _{CES}	V _{GE} = 0 } T _j = 25 °C	-	5	10	mA
	V _{CE} = V _{CES} } T _j = 125 °C	-	20	-	mA
I _{GES}	V _{GE} = 20 V, V _{CE} = 0	-	-	1	μA
V _{CEsat}	I _C = 400 A } V _{GE} = 15 V;	-	2,5(3,1)	3(3,7)	V
V _{CEsat}	I _C = 500 A } T _j = 25 (125) °C	-	2,8(3,3)	-	V
g _{fs}	V _{CE} = 20 V, I _C = 400 A	216	-	-	S
C _{CHC}		-	-	1500	pF
C _{ies}	} V _{GE} = 0 } V _{CE} = 25 V } f = 1 MHz	-	26	40	nF
C _{oes}		-	4	5,2	nF
C _{res}		-	2	2,6	nF
L _{CE}		-	-	20	nH
t _{d(on)}	} V _{CC} = 600 V } V _{GE} = +15 V / -15 V ³⁾ } I _C = 400 A, ind. load } R _{Gon} = R _{Goff} = 3,3 Ω } T _j = 125 °C	-	250	600	ns
t _r		-	170	340	ns
t _{d(off)}		-	900	1100	ns
t _f		-	100	125	ns
E _{on} ⁵⁾		-	45	-	mWs
E _{off} ⁵⁾		-	53	-	mWs
Inverse Diode ⁸⁾					
V _F = V _{EC}	I _F = 400 A } V _{GE} = 0 V;	-	2,0(1,8)	2,5	V
V _F = V _{EC}	I _F = 500 A } T _j = 25 (125) °C	-	2,25(2,1)	-	V
V _{TO}	T _j = 125 °C	-	-	1,2	V
r _T	T _j = 125 °C	-	1,5	3	mΩ
I _{RRM}	I _F = 400 A; T _j = 25 (125) °C ²⁾	-	90(160)	-	A
Q _{rr}	I _F = 400 A; T _j = 25 (125) °C ²⁾	-	15(50)	-	μC
Thermal Characteristics					
R _{thjc}	per IGBT	-	-	0,041	°C/W
R _{thjc}	per diode D	-	-	0,09	°C/W
R _{thch}	per module	-	-	0,038	°C/W

SEMITRANS® M IGBT Modules

SKM 500 GA 123 D
SKM 500 GA 123 DS ⁴⁾



SEMITRANS 4 S

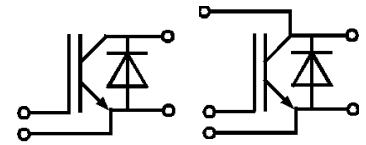

GA

GA ... S

Features

- MOS input (voltage controlled)
- N channel, Homogeneous Si
- Low inductance case
- Very low tail current with low temperature dependence
- High short circuit capability, self limiting to 6 * I_{cnom}
- Latch-up free
- Fast & soft inverse CAL diodes⁸⁾
- Isolated copper baseplate using DCB Direct Copper Bonding Technology
- Large clearance (12 mm) and creepage distances (20 mm).

Typical Applications: → B 6-211

- Switching (not for linear use)

1) T_{case} = 25 °C, unless otherwise specified

2) I_F = - I_C, V_R = 600 V, - di_F/dt = 2000 A/μs, V_{GE} = 0 V

3) Use V_{GEoff} = -5 ... -15 V

4) Suffix "S": with terminal 4 = collector sense for direct V_{CEsat} monitoring for short circuit protection

5) See fig. 2 + 3; R_{Goff} = 3,3 Ω

7) V_{isol} = 4000 V_{rms} on request

8) CAL = Controlled Axial Lifetime Technology.

Cases and mech. data

SEMITRANS 4 → B6-276

SEMITRANS 4 S → B6-212

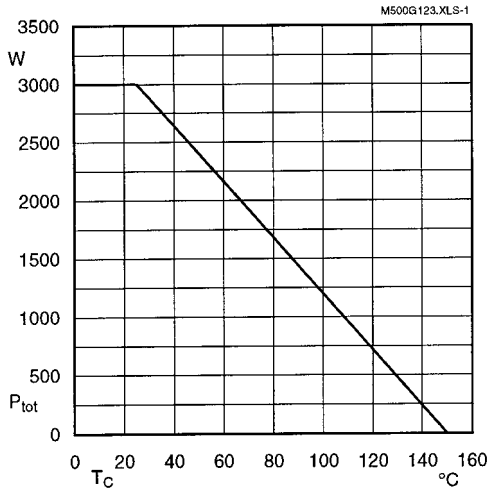

Fig. 1 Rated power dissipation $P_{tot} = f(T_C)$

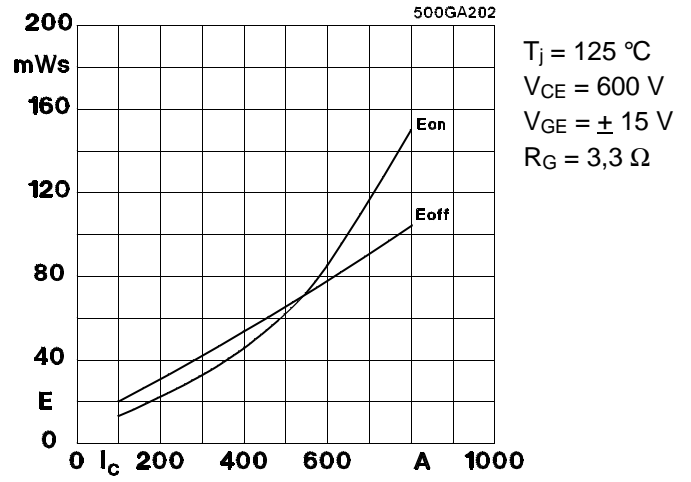

Fig. 2 Turn-on /-off energy $= f(I_C)$

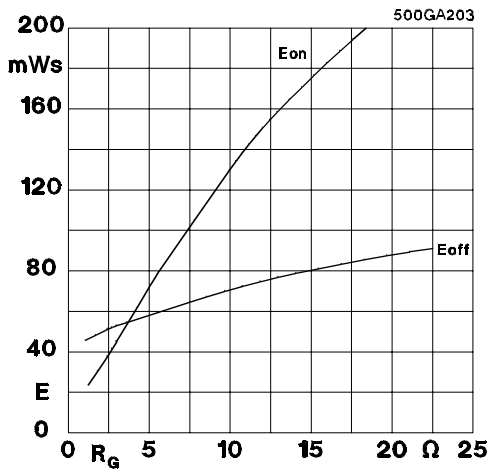

Fig. 3 Turn-on /-off energy $= f(R_G)$

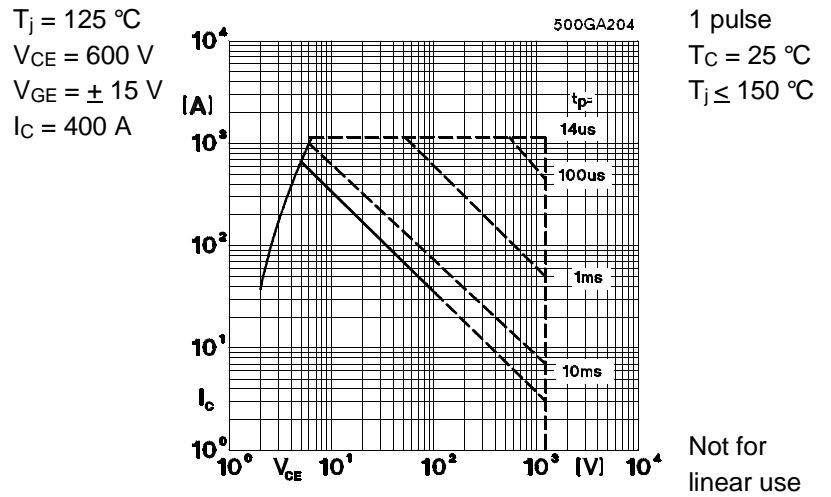

Fig. 4 Maximum safe operating area (SOA) $I_C = f(V_{CE})$

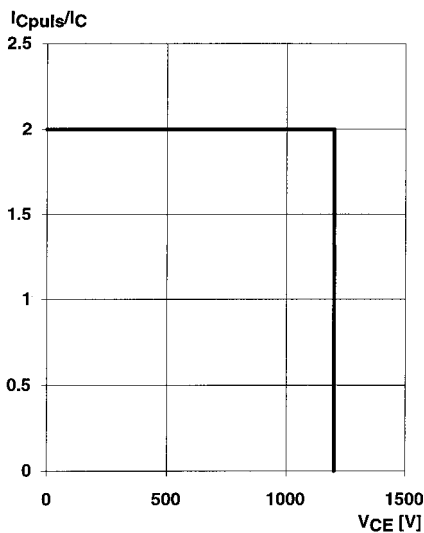

Fig. 5 Turn-off safe operating area (RBSOA)

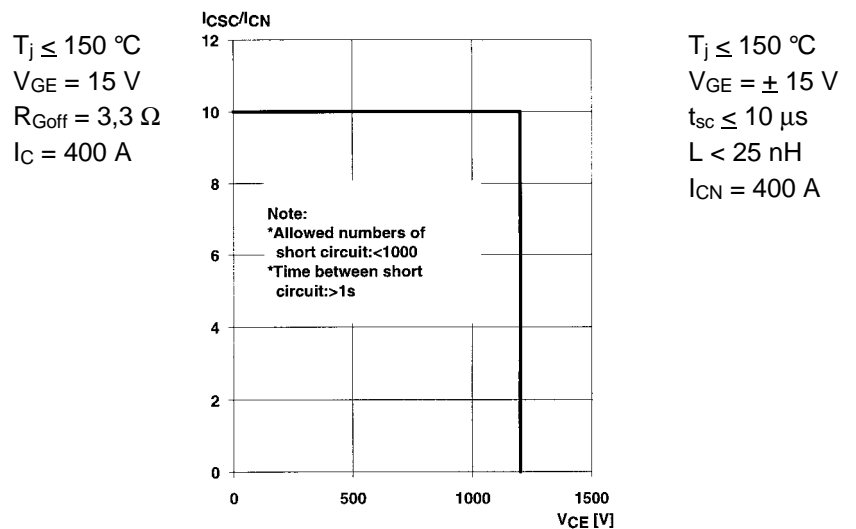

Fig. 6 Safe operating area at short circuit $I_C = f(V_{CE})$

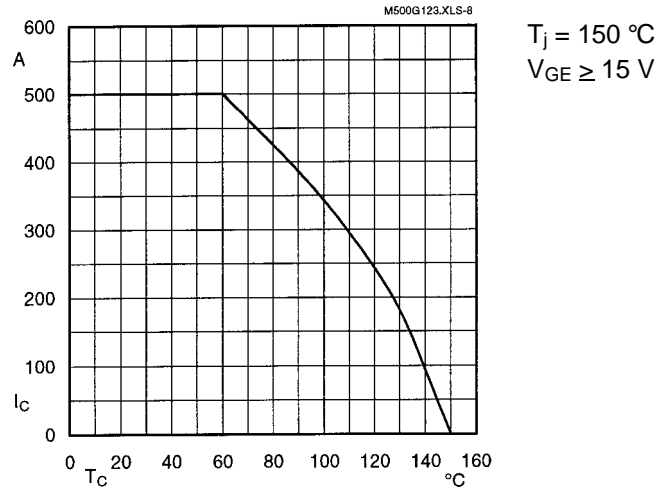

Fig. 8 Rated current vs. temperature $I_c = f(T_c)$

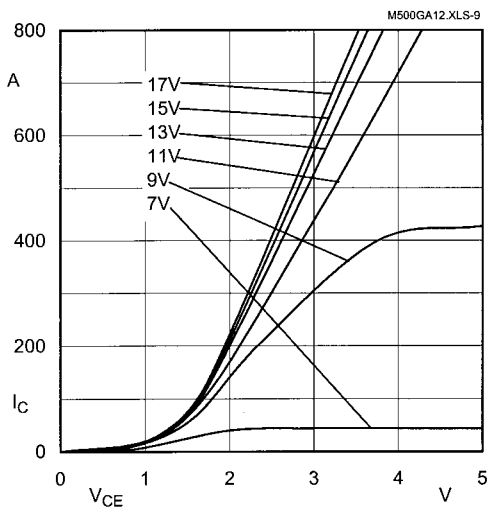

Fig. 9 Typ. output characteristic, $t_p = 80\text{ }\mu\text{s}$; $25\text{ }^\circ\text{C}$

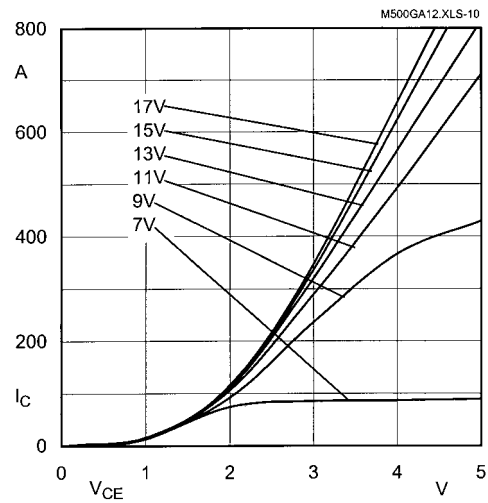

Fig. 10 Typ. output characteristic, $t_p = 80\text{ }\mu\text{s}$; $125\text{ }^\circ\text{C}$

$$P_{\text{cond}}(t) = V_{\text{CEsat}}(t) \cdot I_c(t)$$

$$V_{\text{CEsat}}(t) = V_{\text{CE(TO)(Tj)}} + r_{\text{CE(Tj)}} \cdot I_c(t)$$

$$V_{\text{CE(TO)(Tj)}} \leq 1,5 + 0,002 (T_j - 25) \text{ [V]}$$

$$\text{typ.: } r_{\text{CE(Tj)}} = 0,0025 + 0,00001 (T_j - 25) \text{ [\Omega]}$$

$$\text{max.: } r_{\text{CE(Tj)}} = 0,0038 + 0,000013 (T_j - 25) \text{ [\Omega]}$$

$$\text{valid for } V_{\text{GE}} = +15 \begin{matrix} +2 \\ -1 \end{matrix} \text{ [V]; } I_c > 0,3 I_{\text{Cnom}}$$

Fig. 11 Saturation characteristic (IGBT)
Calculation elements and equations

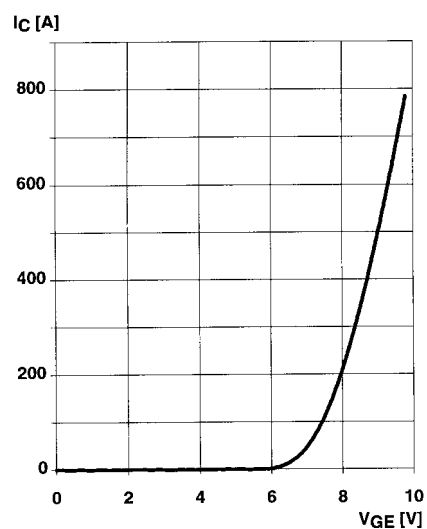

Fig. 12 Typ. transfer characteristic, $t_p = 80\text{ }\mu\text{s}$; $V_{CE} = 20\text{ V}$

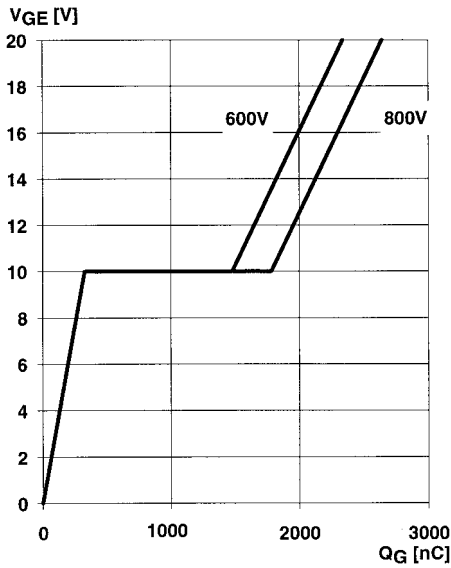
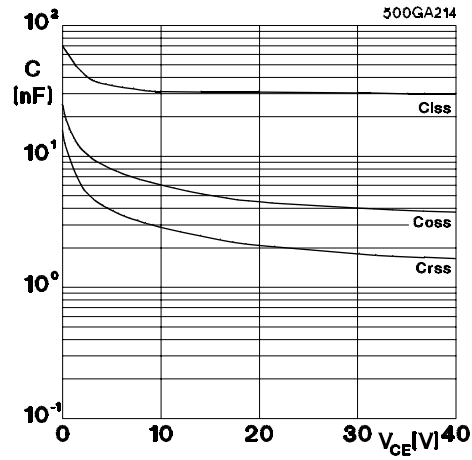

Fig. 13 Typ. gate charge characteristic

$I_{Cpuls} = 400 \text{ A}$



$V_{GE} = 0 \text{ V}$
 $f = 1 \text{ MHz}$

Fig. 14 Typ. capacitances vs. V_{CE}

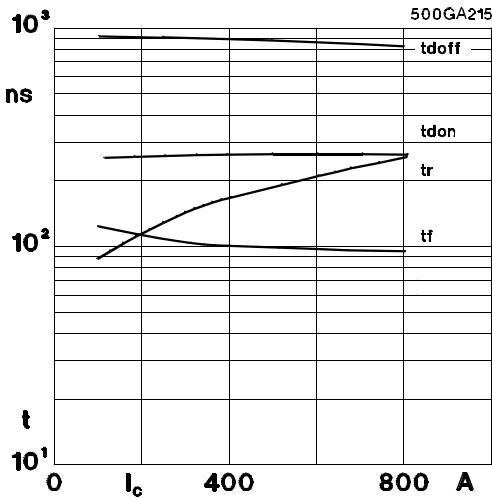

$T_j = 125 \text{ }^\circ\text{C}$
 $V_{CE} = 600 \text{ V}$
 $V_{GE} = \pm 15 \text{ V}$
 $R_{Gon} = 3,3 \text{ } \Omega$
 $R_{Goff} = 3,3 \text{ } \Omega$
induct. load

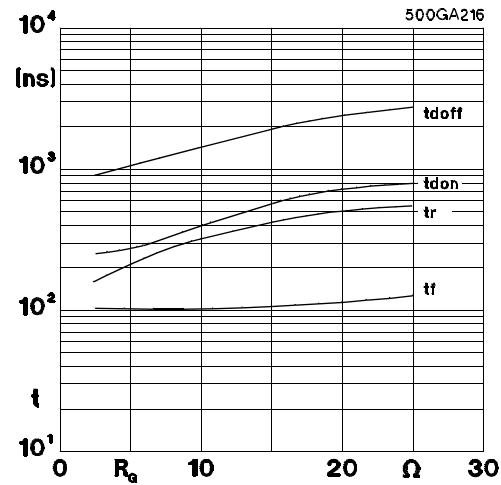

$T_j = 125 \text{ }^\circ\text{C}$
 $V_{CE} = 600 \text{ V}$
 $V_{GE} = \pm 15 \text{ V}$
 $I_C = 400 \text{ A}$
induct. load

Fig. 15 Typ. switching times vs. I_C

Fig. 16 Typ. switching times vs. gate resistor R_G

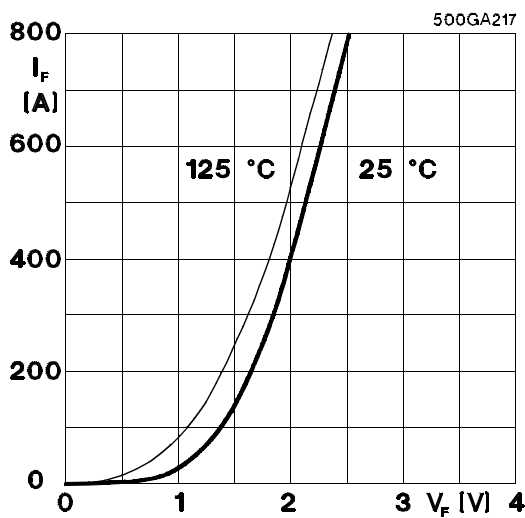

Fig. 17 Typ. CAL diode forward characteristic

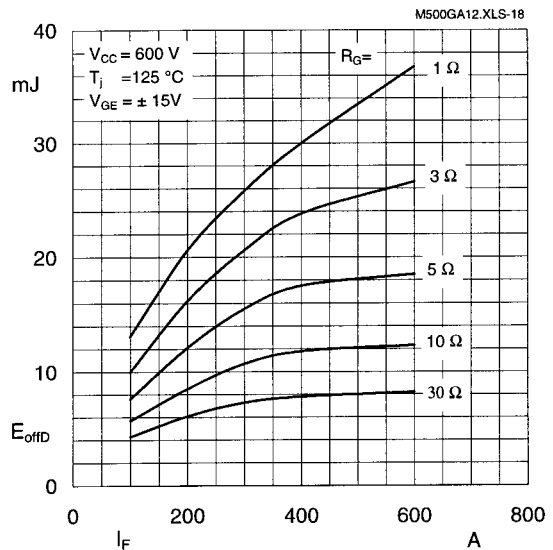

Fig. 18 Diode turn-off energy dissipation per pulse

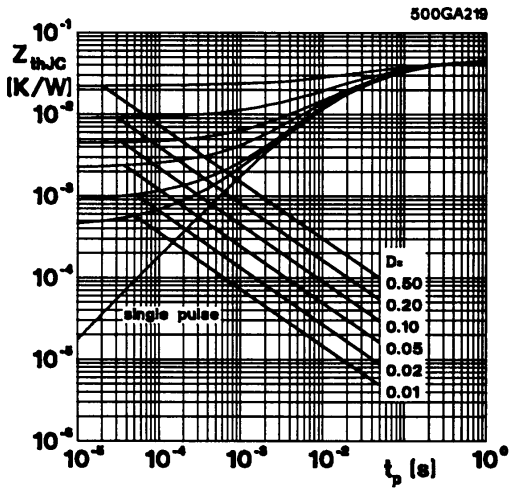

Fig. 19 Transient thermal impedance of IGBT
 $Z_{thJC} = f(t_p)$; $D = t_p / t_c = t_p \cdot f$

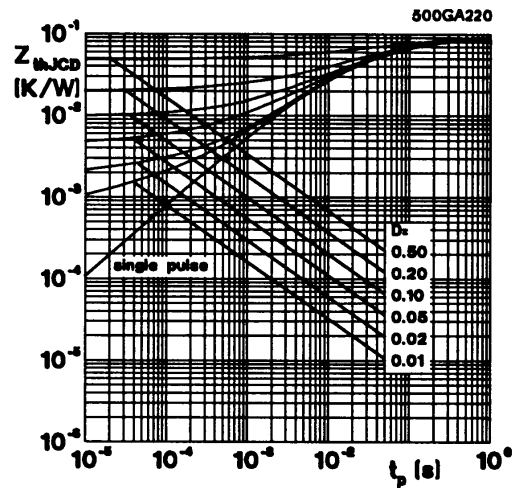

Fig. 20 Transient thermal impedance of inverse CAL diodes
 $Z_{thJC} = f(t_p)$; $D = t_p / t_c = t_p \cdot f$

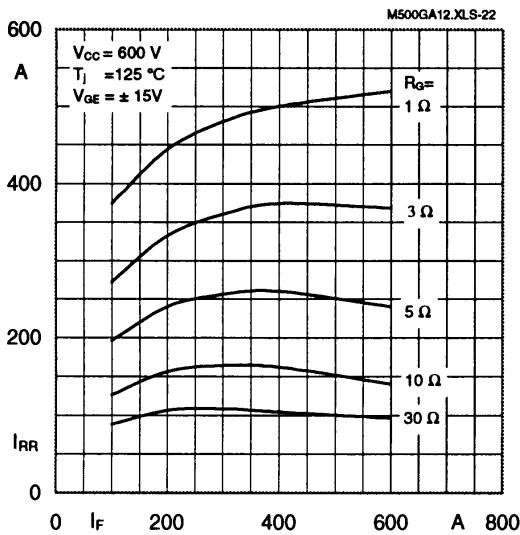

Fig. 22 Typ. CAL diode peak reverse recovery current $I_{RR} = f(I_c; R_G)$

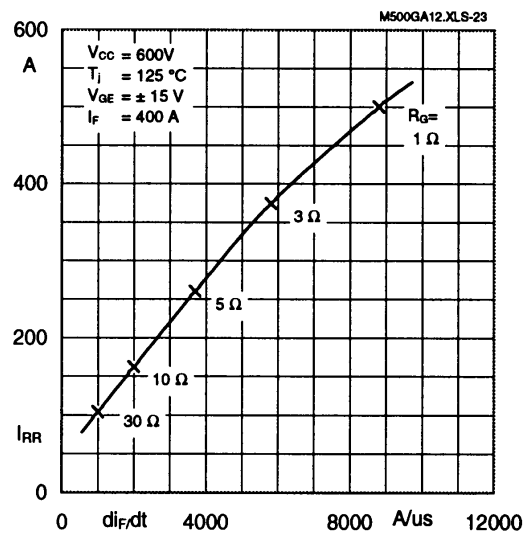

Fig. 23 Typ. CAL diode peak reverse recovery current $I_{RR} = f(di/dt)$

Typical Applications include

- Switched mode power supplies
- DC servo and robot drives
- Inverters
- DC choppers
- AC motor speed control
- Inductive heating
- UPS Uninterruptable power supplies
- General power switching applications
- Electronic (also portable) welders
- Pulse frequencies also above 15 kHz

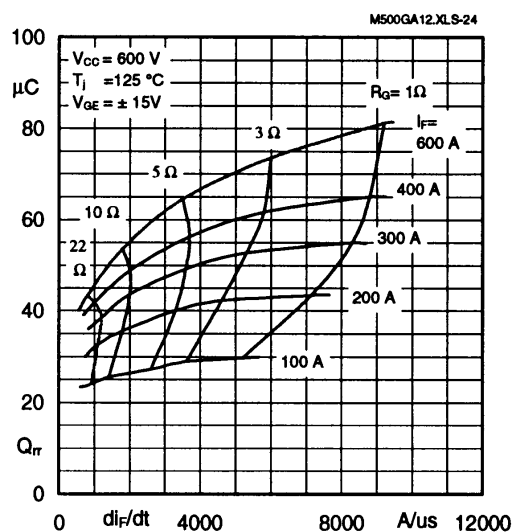

Fig. 24 Typ. CAL diode recovered charge

SKM 500 GA 123 D ...

SEMITRANS 4 S

Case D 60

UL Recognized

File no. E 63 532

CASED60

SKM 500 GA 123 DS

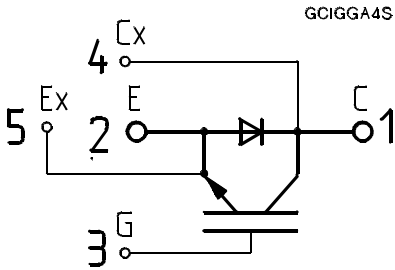
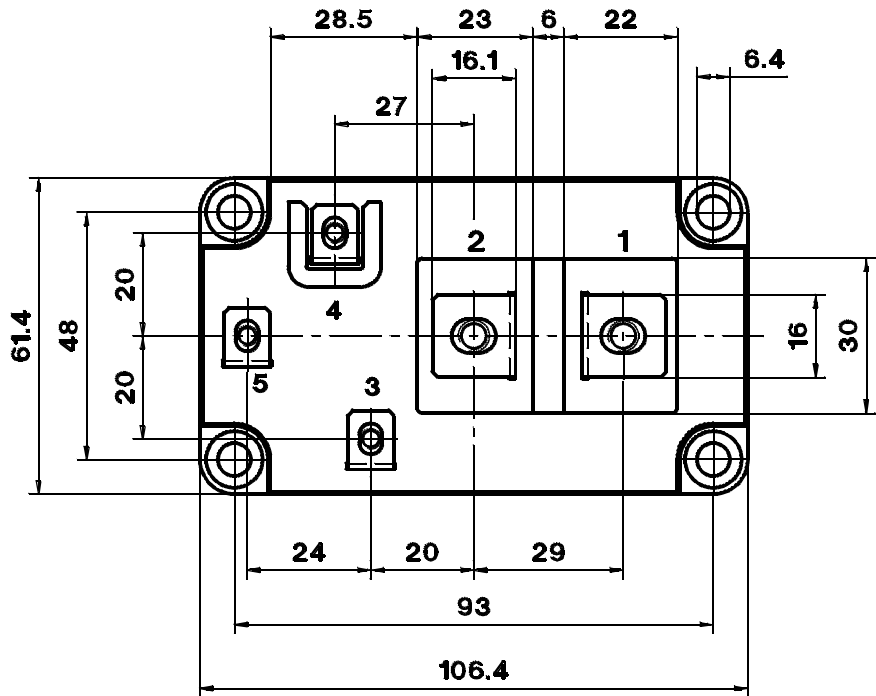
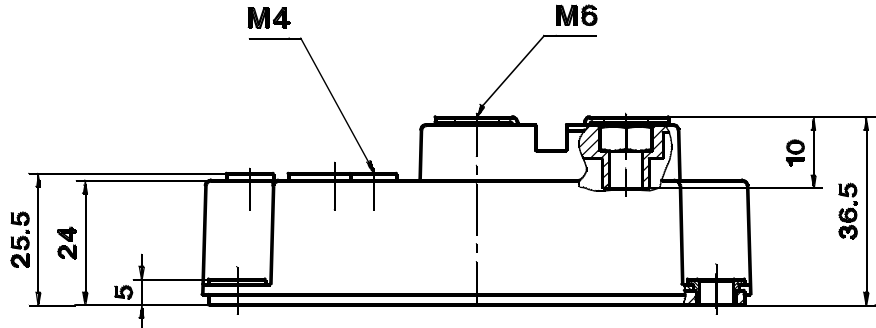

Dimensions in mm

Outline and circuit

Outline of SKM 500 GA 123 D → B6 -276

Symbol	Conditions	Values			Units
		min.	typ.	max.	
M ₁	to heatsink, SI Units (M6)	3	–	5	Nm
	to heatsink, US Units	27	–	44	lb.in.
M ₂	for terminals, SI Units (M6/M4)	2,5/1,1	–	5/2	Nm
	for terminals US Units	22/10	–	44/18	lb.in.
a		–	–	5x9,81	m/s ²
w		–	–	330	g

This is an electrostatic discharge sensitive device (ESDS). Please observe the international standard IEC 747-1, Chapter IX.

Three devices are supplied in one SEMIBOX B without mounting hardware, which can be ordered separately under Ident No. 33321100 (for 10 SEMITRANS 4). Larger packing units of 12 and 20 pieces are used if suitable
 Accessories → B 6 - 4.
 SEMIBOX B → C - 2.