

| | | | | | | |
|------------------|------------------|-----------------------|--|----------------------------|--------------|--------------|
| V _{RSM} | V _{RRM} | (dv/dt) _{cr} | I _{TRMS} (maximum value for continuous operation) | | | |
| | V _{DRM} | | 150 A | | | |
| V | V | V/μs | I _{TAV} (sin. 180; T _{case} = 85°C) | | | |
| | | | 95 A | | | |
| 500 | 400 | 500 | – | – | SKKH 91/04 D | – |
| 700 | 600 | 500 | SKKT 91/06 D | SKKT 92/06 D | SKKH 91/06 D | SKKH 92/06 D |
| 900 | 800 | 500 | SKKT 91/08 D | SKKT 92/08 D | SKKH 91/08 D | SKKH 92/08 D |
| 1300 | 1200 | 1000 | SKKT 91/12 E | SKKT 92/12 E ¹⁾ | SKKH 91/12 E | SKKH 92/12 E |
| 1500 | 1400 | 1000 | SKKT 91/14 E | SKKT 92/14 E ¹⁾ | SKKH 91/14 E | SKKH 92/14 E |
| 1700 | 1600 | 1000 | SKKT 91/16 E | SKKT 92/16 E ¹⁾ | SKKH 91/16 E | SKKH 92/16 E |
| 1900 | 1800 | 1000 | SKKT 91/18 E | SKKT 92/18 E ¹⁾ | SKKH 91/18 E | SKKH 92/18 E |

SEMIPACK® 1 Thyristor / Diode Modules

SKKT 91 SKKH 91
SKKT 92 SKKH 92
SKKT 92B SKMT 92²⁾
SKKL 92²⁾

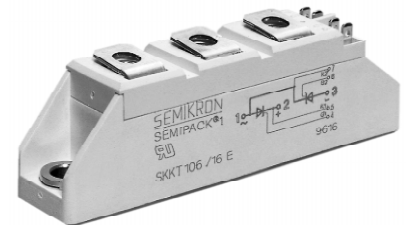

| Symbol | Conditions | SKKT 91 SKKH 91 | SKKT 92 SKKT 92B SKKH 92 | Units |
|-----------------------------------|--|-------------------------------------|--------------------------------|------------------|
| I _{TAV} | sin. 180; T _{case} = 85°C | 95 | | A |
| I _D | B2/B6 T _{amb} = 45 °C; P 3/180 | 70 / 85 | | A |
| | T _{amb} = 35 °C; P 3/180 F | 140/ 175 | | A |
| I _{RMS} | W1/W3 T _{amb} = 35 °C; P 3/180 F | 190 / 3 x 135 | | A |
| I _{TSM} | T _{vj} = 25 °C; 10 ms | 2 000 | | A |
| | T _{vj} = 125 °C; 10 ms | 1 750 | | A |
| i ² t | T _{vj} = 25 °C; 8,3 ... 10 ms | 20 000 | | A ² s |
| | T _{vj} = 125 °C; 8,3 ... 10 ms | 15 000 | | A ² s |
| t _{gd} | T _{vj} = 25 °C; I _G = 1 A; di _G /dt = 1 A/μs | 1 | | μs |
| t _{gr} | V _D = 0,67 · V _{DRM} | 2 | | μs |
| (di/dt) _{cr} | T _{vj} = 125 °C | 150 | | A/μs |
| t _q | T _{vj} = 125 °C | typ. 100 | | μs |
| I _H | T _{vj} = 25 °C; max. | 250 | | mA |
| I _L | T _{vj} = 25 °C; R _G = 33 Ω; max. | 600 | | mA |
| V _T | T _{vj} = 25 °C; I _T = 300 A | max. 1,65 | | V |
| V _{T(TO)} | T _{vj} = 125 °C | 0,9 | | V |
| r _T | T _{vj} = 125 °C | 2 | | mΩ |
| I _{DD} ; I _{RD} | T _{vj} = 125 °C; V _{RD} = V _{RRM} V _{DD} = V _{DRM} | max. 20 | | mA |
| V _{GT} | T _{vj} = 25 °C; d.c. | 3 | | V |
| I _{GT} | T _{vj} = 25 °C; d.c. | 150 | | mA |
| V _{GD} | T _{vj} = 125 °C; d.c. | 0,25 | | V |
| I _{GD} | T _{vj} = 125 °C; d.c. | 6 | | mA |
| R _{thjc} | cont. } per thyristor / sin. 180 } per module rec. 120 } | 0,28 / 0,14 | | °C/W |
| | | 0,30 / 0,15 | | °C/W |
| | | 0,32 / 0,16 | | °C/W |
| R _{thch} | | 0,2 / 0,1 | | °C/W |
| T _{vj} | | – 40 ... + 125 | | °C |
| T _{stg} | | – 40 ... + 125 | | °C |
| V _{isol} | a. c. 50 Hz; r.m.s.; 1 s/1 min | 3600 / 3000 | | V~ |
| M ₁ | to heatsink } SI (US) units | 5 (44 lb. in.) ± 15 % ³⁾ | | Nm |
| M ₂ | to terminals } | 3 (26 lb. in.) ± 15 % | | Nm |
| a | | 5 · 9,81 | | m/s ² |
| w | approx. | 95 | | g |
| Case | → page B 1 – 95 | SKKT 91: A 5 | SKKL 92: A 59 | |
| | | SKKH 91: A 6 | SKKT 92: A 46 | |
| | | SKMT 92: A 72 | SKKH 92: A 47 | |
| | | | SKKT 92B: A 48 | |



SKKT 91 SKKH 91



SKKT 92
SKKT 92B SKKH 92



SKMT 92 SKKL 92

Features

- Heat transfer through aluminium oxide ceramic isolated metal baseplate
- Hard soldered joints for high reliability
- UL recognized, file no. E 63 532

Typical Applications

- DC motor control (e.g. for machine tools)
- AC motor soft starters
- Temperature control (e.g. for ovens, chemical processes)
- Professional light dimming (studios, theaters)

1) Also available in SKKT 92B configuration (case A 48)

2) SKKL 92, SKMT 92 available on request

3) See the assembly instructions

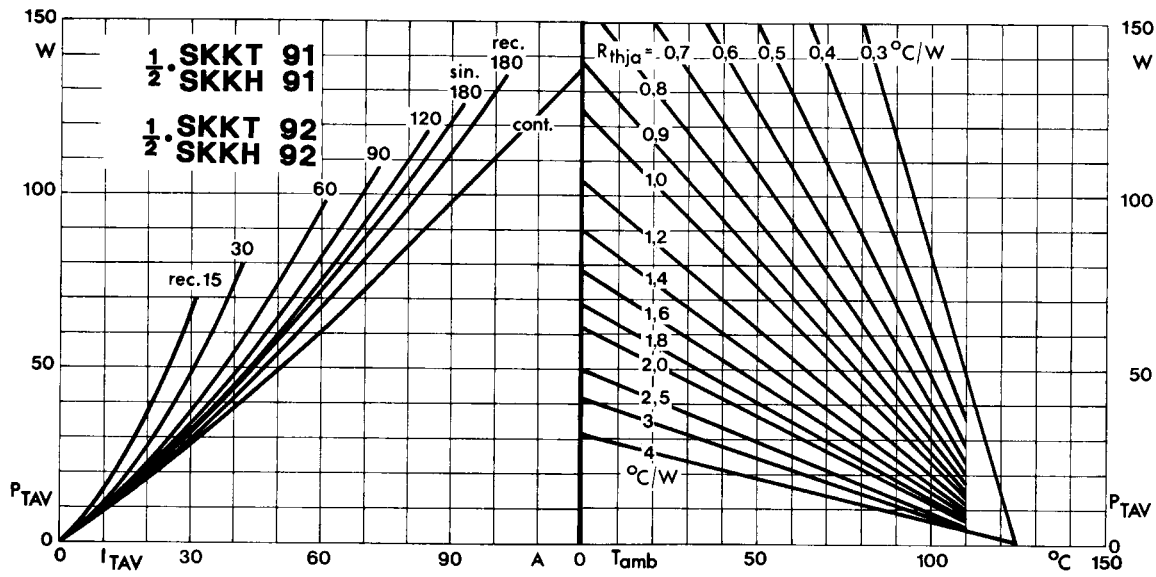

Fig. 1 Power dissipation per thyristor vs. on-state current and ambient temperature

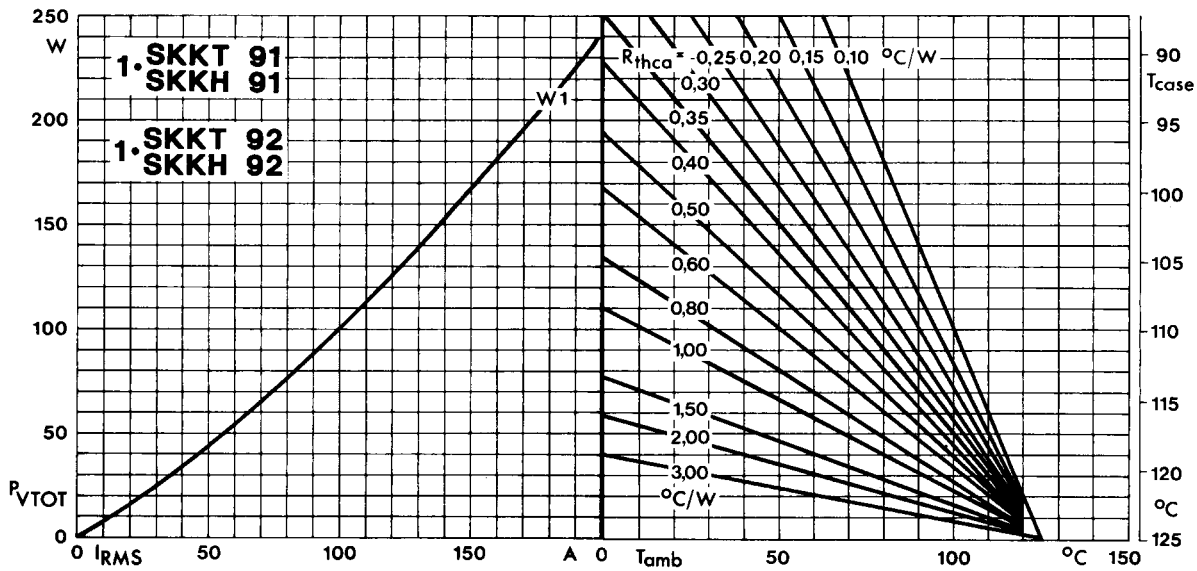

Fig. 2 Power dissipation per module vs. rms current and case temperature

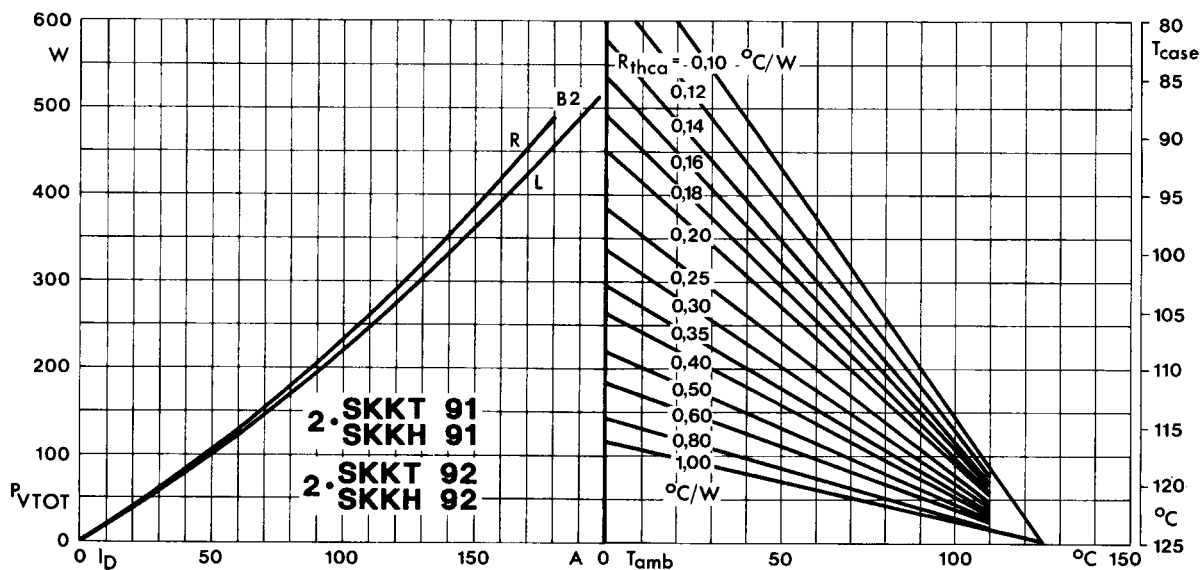

Fig. 3 Power dissipation of two modules vs. direct current and case temperature

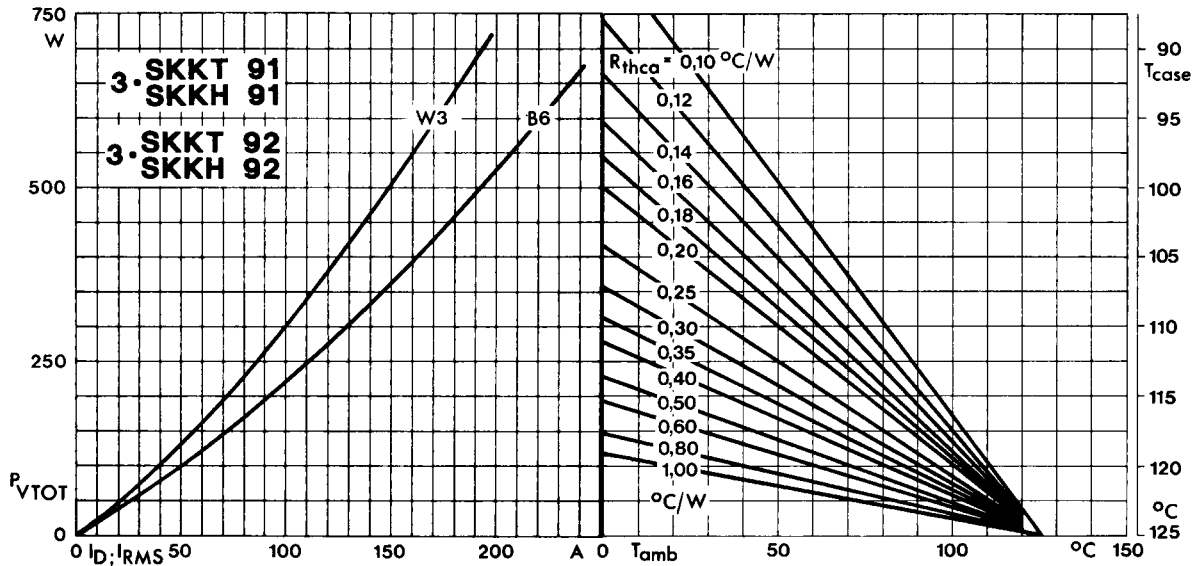

Fig. 4 Power dissipation of three modules vs. direct and rms current and case temperature

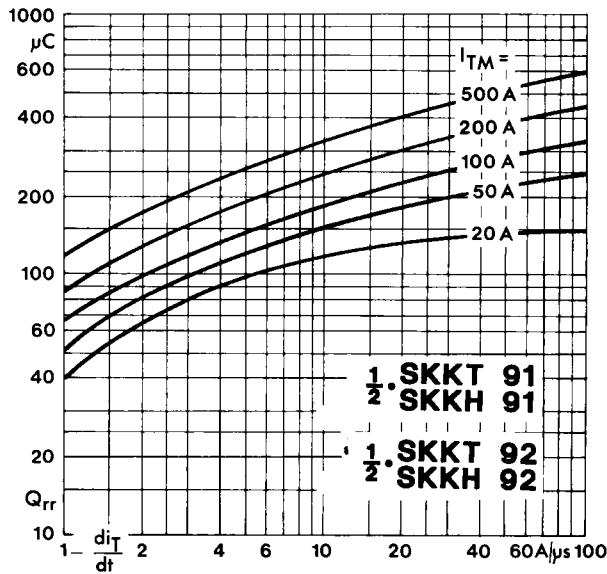

Fig. 5 Recovered charge vs. current decrease

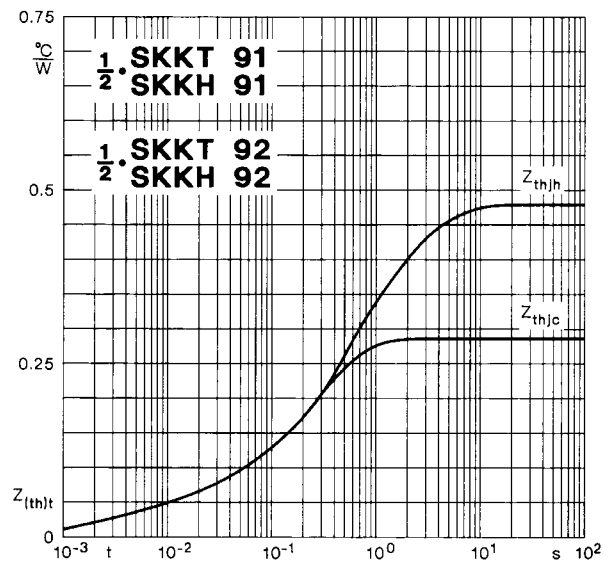

Fig. 6 Transient thermal impedance vs. time

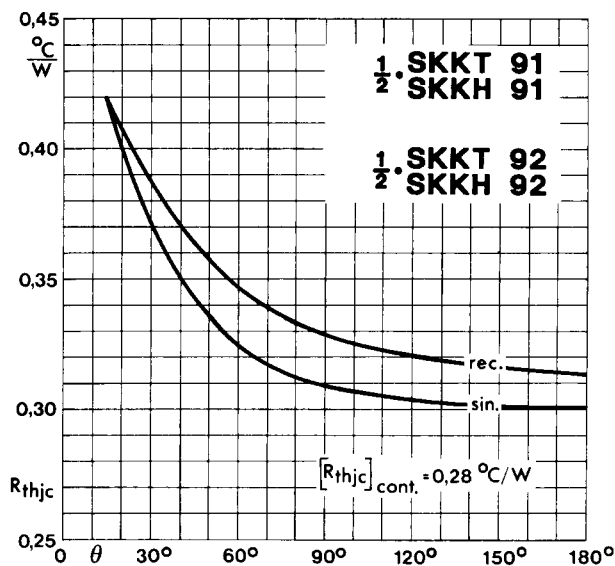

Fig. 7 Thermal resistance vs. conduction angle

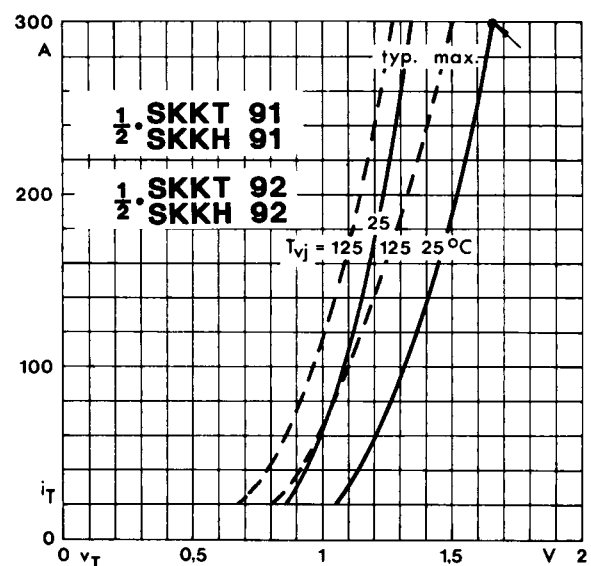

Fig. 8 On-state characteristics

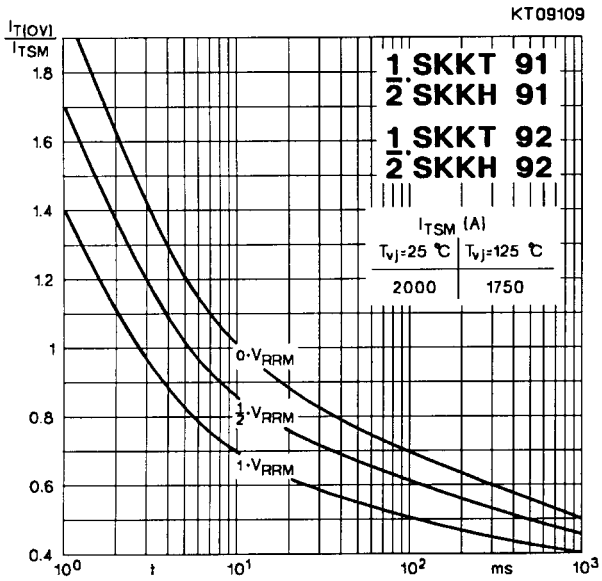

Fig. 9 Surge overload current vs. time

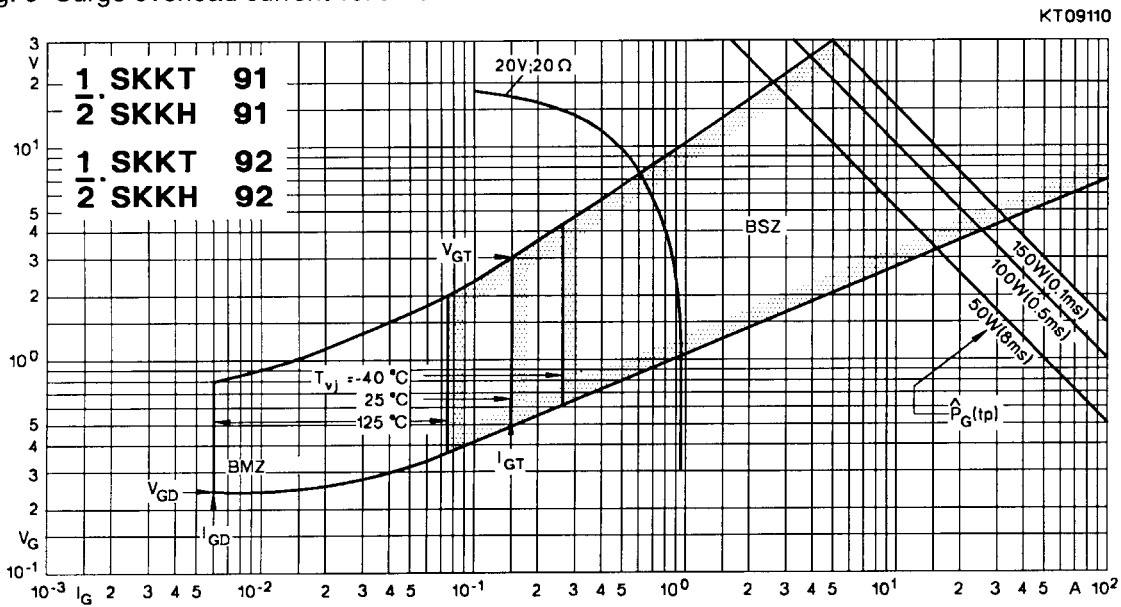

Fig. 10 Gate trigger characteristics

SKKT 19 ... 105

Case A 5

IEC 192-2: A 77 A

JEDEC: TO-240 AA

SEMIPACK® 1

UL recognized, file no. E 63 532



Dimensions in mm

SKKT 20/ ... 106/

Case A 46

IEC 192-2: A 77 A

JEDEC: TO-240 AA

SEMIPACK® 1

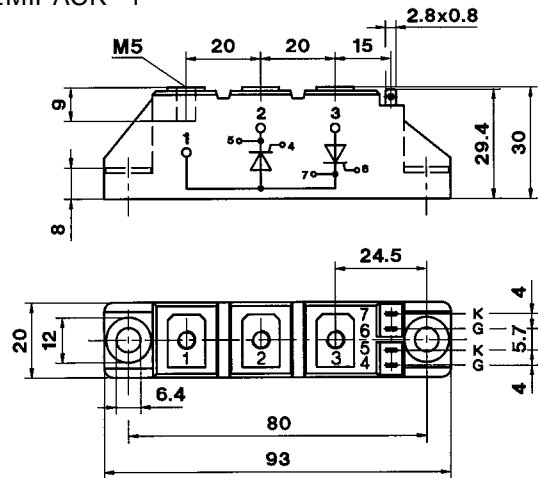

Dimensions in mm

SKKH 26 ... 105

Case A 6

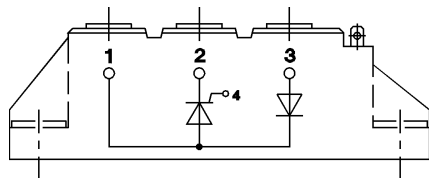

SKKD 26 ... 100

Case A 10

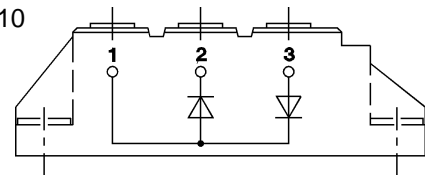

SKNH 56 ... 91

Case A 7

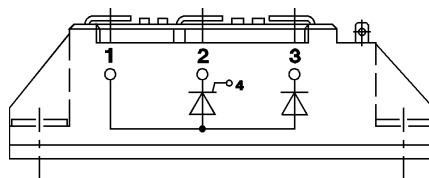

SKKE 81

Case A 12

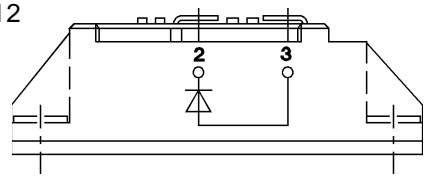

SKKL 56 ... 105

Case A 9

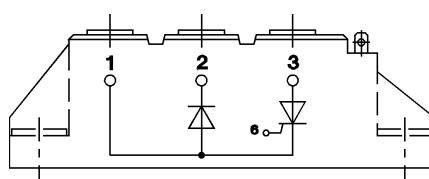

SKKH 27 ... 106

Case A 47

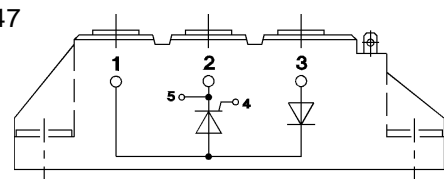

SKND 46 ... 81

Case A 19

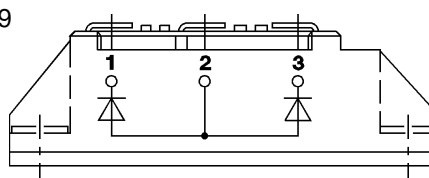

SKKT 20 B ... 106 B

Case A 48

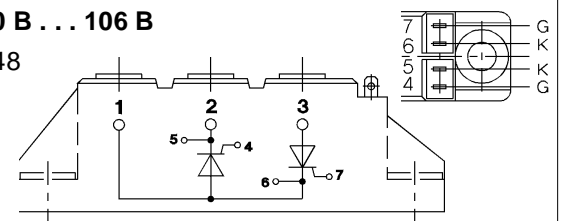

SKMT 92

Case A 72

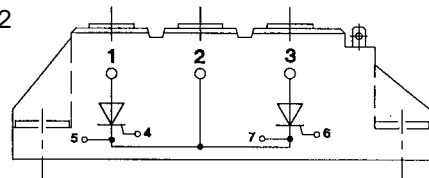

SKKL 42 ... 106

Case A 59

