



SEMIPONT[®] 4

Power Bridge Rectifiers

SKD 110

Features

- Robust plastic case with screw terminals
- Large, isolated base plate
- Blocking voltage up to 1800 V
- High surge currents
- Three phase bridge rectifier
- Easy chassis mounting
- UL recognized, file no. E 63 532

Typical Applications

- Three phase rectifiers for power supplies
- Input rectifiers for variable frequency drives
- Rectifiers for DC motor field supplies
- Battery charger rectifiers

1) Available in limited quantities

2) Mounted on a painted metal sheet of min. 250 x 250 x 1 mm;

$$R_{th(c-a)} = 1,8 \text{ K/W}$$

V_{RSM} V	V_{RRM}, V_{DRM} V	$I_D = 110 \text{ A}$ (full conduction) ($T_c = 100 \text{ }^\circ\text{C}$)
400	400	SKD 110/04
800	800	SKD 110/08
1200	1200	SKD 110/12
1400	1400	SKD 110/14
1600	1600	SKD 110/16
1800	1800	SKD 110/18 ¹⁾

Symbol	Conditions	Values	Units
I_D	$T_c = 85 \text{ }^\circ\text{C}$	151	A
	$T_a = 45 \text{ }^\circ\text{C}$; chassis ²⁾	28	A
	$T_a = 45 \text{ }^\circ\text{C}$; P1/200	70	A
	$T_a = 35 \text{ }^\circ\text{C}$; P1/120 F	110	A
	$T_a = 35 \text{ }^\circ\text{C}$; P3/120 F	123	A
I_{FSM}	$T_{vj} = 25 \text{ }^\circ\text{C}$; 10 ms	1200	A
	$T_{vj} = 150 \text{ }^\circ\text{C}$; 10 ms	1000	A
i^2t	$T_{vj} = 25 \text{ }^\circ\text{C}$; 8,3 ... 10 ms	7200	A ² s
	$T_{vj} = 150 \text{ }^\circ\text{C}$; 8,3 ... 10 ms	5000	A ² s
V_F	$T_{vj} = 25 \text{ }^\circ\text{C}$; $I_F = 300 \text{ A}$	max. 1,9	V
$V_{(TO)}$	$T_{vj} = 150 \text{ }^\circ\text{C}$	max. 0,85	V
r_T	$T_{vj} = 150 \text{ }^\circ\text{C}$	max. 4	m Ω
I_{RD}	$T_{vj} = 25 \text{ }^\circ\text{C}$; $V_{DD} = V_{DRM}$; $V_{RD} = V_{RRM}$	max. 0,5	mA
	$T_{vj} = 150 \text{ }^\circ\text{C}$; $V_{RD} = V_{RRM}$	5	mA
$R_{th(j-c)}$	per diode	0,9	K/W
	total	0,15	K/W
$R_{th(c-s)}$	total	0,03	K/W
T_{vj}		- 40 ... + 150	$^\circ\text{C}$
T_{stg}		- 40 ... + 125	$^\circ\text{C}$
V_{isol}	a. c. 50 Hz; r.m.s.; 1 s / 1 min.	3600 (3000)	V
M_s	to heatsink	$5 \pm 15 \%$	Nm
M_t	to terminals	$5 \pm 15 \%$	Nm
m		270	g
Case		G 37	

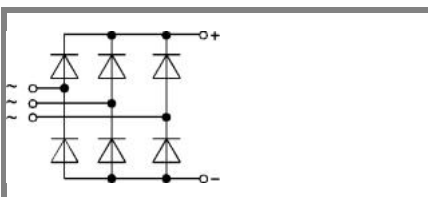

SKD

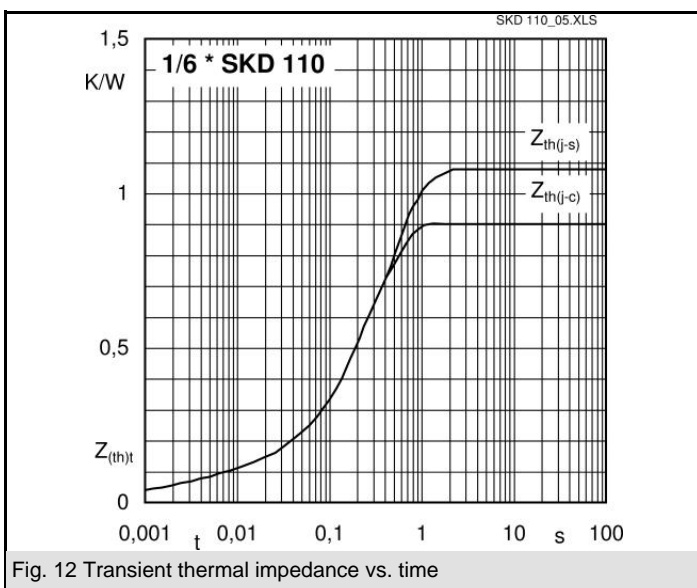
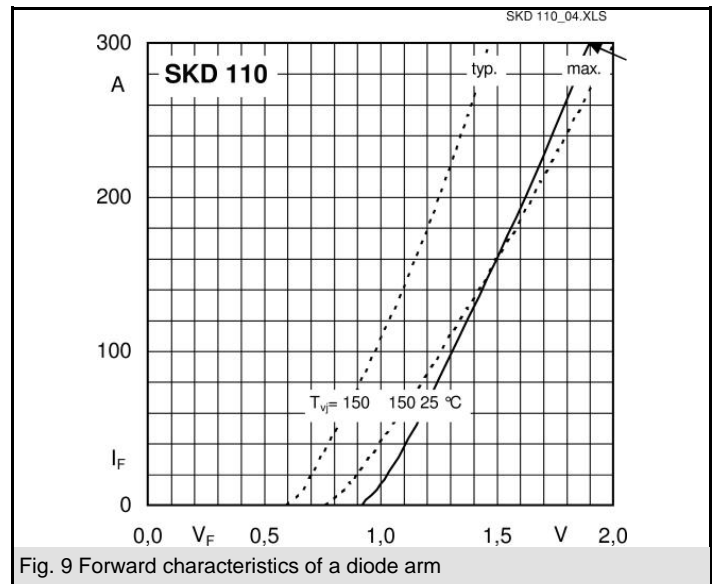
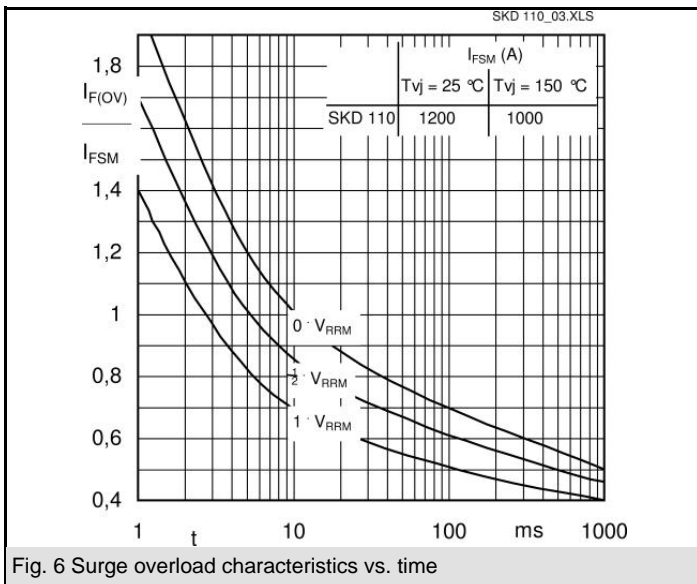
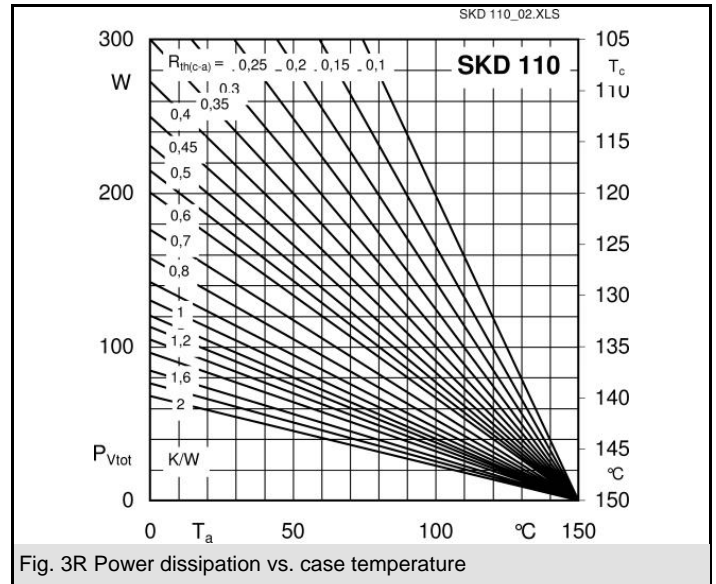
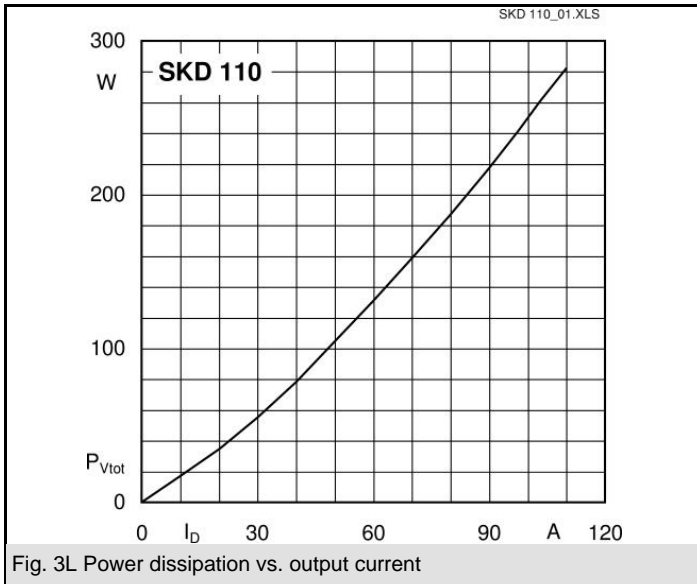

Dimensions in mm

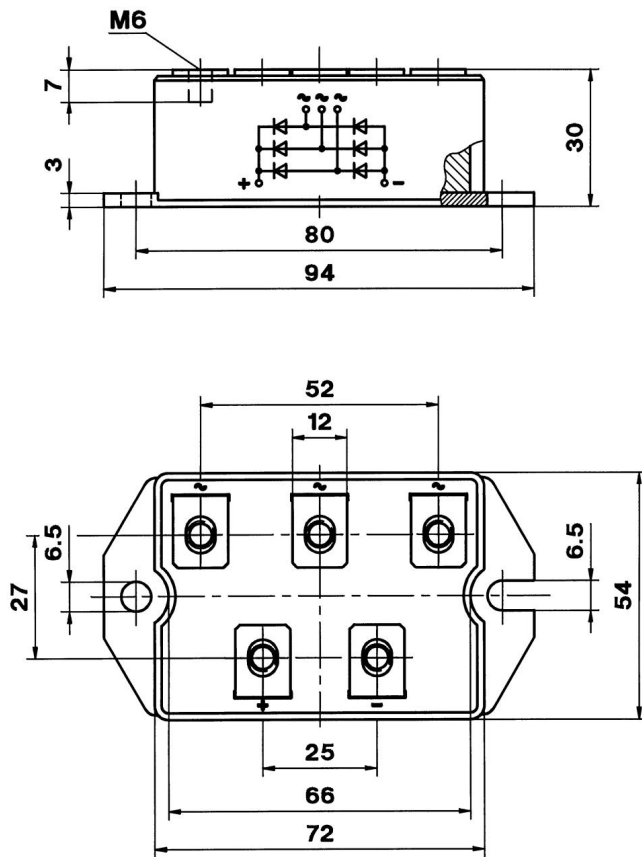

Case G 37

This technical information specifies semiconductor devices but promises no characteristics. No warranty or guarantee expressed or implied is made regarding delivery, performance or suitability.