

■ Description

The highest priority for the molded case circuit breakers (MCCBs) and earth leakage circuit breakers (ELCBs) employed in power distribution control systems is to provide sure, safe protection for connected equipment against short-circuits or earth leakage. Fuji Electric FA has led the industry with the α -TWIN Breakers (30 to 800AF), same-size MCCBs and ELCBs. All of these breakers meet exacting demands for quality and performance.

Now, the lineup has been further enhanced with six major concepts — international standardization, utility, technical innovation, compactness, safety and ecology — in the α -TWIN series.

• Outstanding features

α -TWIN Breakers employ a new current-limiting mechanism based on the arc-driving technique for high-speed contact opening and very short arcing time. This, and a dual-latching mechanism, enable 30AF and 225AF MCCBs to interrupt current faster at higher capacities. A special resin with excellent thermal and mechanical

properties produces a more compact molded case for higher breaking capacity.

• Standardized modular construction

Standardized dimensions ease panel design and manufacture. Models 30AF to 225AF are 60mm deep and require a panel cutout height of 52mm.

Models 400AF to 800AF are 103mm deep and require a panel cutout height of 92mm.

With standardized modular construction, α -TWIN Breakers cut panel manufacturing costs.

• A wider range of customer-mountable accessories

The range of cassette-type internal accessories has been greatly expanded for 30AF to 800AF MCCBs.

This speeds up and simplifies customer response to specification changes.

All accessories shown here can be mounted by the customer except for motor operating mechanism and plate type padlocking device.



• Conforming to international standards

The α -TWIN series conforms to IEC and EN standards, and features UL, cUL and CCC.

• Compliance with EN Standards

FUJI's MCCBs conform to the European Standards for circuit breakers (EN60947-2 = IEC60947-2). (E and S series, 30AF to 800AF only)

■ Types of MCCBs

• Line protection

For general-purpose circuit protection

This type of MCCB may be employed in both main and branch circuits. They are installed in motor control centers and distribution boards to provide protection from both overload and short-circuit currents.

The overcurrent trip mechanism of the general-purpose MCCB consists of thermal and magnetic elements.

Thermal trip action and magnetic trip action provided overcurrent protection and short-circuit protection, respectively.

For distribution boards

These MCCBs are used exclusively in branch circuits of distribution boards for lighting installations. These breaker are compact and suitable for mounting in groups. These circuit breakers are available in 50 and 100AF (Ampere Frame) types, and their breaking capacities are within the 2.5kA to 5.5kA range.

• Motor-protection

The line current ratings of MCCBs for motor protection are equal to the motor's full-load current to provided motor overload and line overcurrent protection. These MCCBs obviate the need for magnetic motor starters. Since these MCCBs control motor start-stop operation, they must be used with loads which do not require frequent switching. These MCCBs handle starting rush currents of up to 600% and enable starting times of up to two seconds.

These MCCBs are for general-purpose, 3-phase squirrel-cage induction motors with direct-on-line starting.

• Solid-state trip

These solid-state trip type MCCBs incorporate a trip device with a built-in microprocessor. Rated current levels can be selected in five to six steps, and a wide variety of tripping parameters, including long-time delay, short-time delay, and instantaneous

tripping, can be set with high precision. These MCCBs are ideal for providing selective trip protection coordination with various protective devices, such as fuses and other MCCB units. This type of MCCB also increases the reliability of the power supply.

Molded Case Circuit Breakers

General information

Models and applications

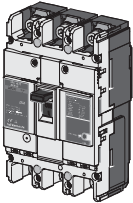
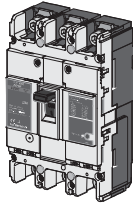
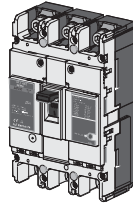
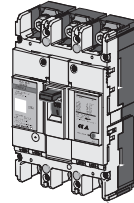
CE marking		UL approved	
Line protection		Motor protection	
S series	E series	S, E series	S-UL, E-UL series
			
Used for equipment with a capacity range of 15 to 20kVA. Satisfies EN (IEC) standards and bears CE markings.	Ideal for circuits with comparatively low short-circuit current. Satisfies EN (IEC) standards and bears CE markings. Enables the design of compact, economical control panels. The depth is 60mm for types with a capacity range of 30 to 225A.	This breaker protects motors from overload and cables from excessive current.	This breaker is UL and CSA approved. Satisfies EN (IEC) standards and bears CE markings.

Varieties of MCCBs

IEC and CE marking conformed

Frame size		30AF	50AF	60AF	100AF	225AF	400AF	600AF	800AF
Line protection	S series	SA30C□-CE	SA50C□-CE SA50RC□-CE	SA60C□-CE SA60RC□-CE	SA100C□-CE SA100RC□-CE	SA225C□-CE SA225RC□-CE	SA400C□-CE SA400RC□-CE	SA600RC□-CE	SA800RC□-CE
	E series	EA30AC□-CE	EA50AC□-CE EA50C□-CE	EA60C□-CE	EA100AC□-CE EA100C□-CE	EA225C□-CE	EA400C□-CE	EA600C□-CE	EA800C□-CE
Motor protection	S series	SA30CM□-CE	SA50CM□-CE SA50RCM□-CE	SA60CM□-CE	SA100CM□-CE SA100RCM□-CE	SA225CM□-CE SA225RCM□-CE	-	-	-
	E series	EA30ACM□-CE	EA50CM□-CE	EA60CM□-CE	EA100CM□-CE	EA225CM□-CE	-	-	-

Note: Type number with "-CE" indicates the IEC and CE marking conformed model, but type number without "-CE" indicates also the same.

UL489 Listed

Frame size		30AF	50AF	60AF	100AF	225AF	400AF	600AF	800AF
UL489 Listed	SA-UL	-	SA50RCUL	-	SA100CUL SA100RCUL	SA225CUL SA225RCUL	SA400CUL SA400RCUL	SA600RCUL	SA800RCUL
	EA-UL	-	-	-	EA100CUL	-	-	-	-

JIS C8370

Frame size	30AF	50AF	60AF	100AF	225AF	400AF	600AF	800AF
S series	-	-	-	-	-	-	-	-
L series H series	-	LA50B H50C	-	H100C H100R	H225C H225R	H400C H400R	H600C H600R	H800C H800R
4-pole	-	SA54B	-	EA104B SA104R	SA204R	SA404HA	SA604H	SA804H
F series	-	F51B F52B F53B	-	F102B F103B	-	-	-	-

Note: Solid-state trip type is also available. SA1000E, 1200E, 1600E

■ Design features

Direct-Drive switching mechanism

A vertical link mechanism is used for the switching mechanism to reduce the torque of the moving contact arm, serve as a countermeasure against increased contact opening distance, and improve contact opening speed.

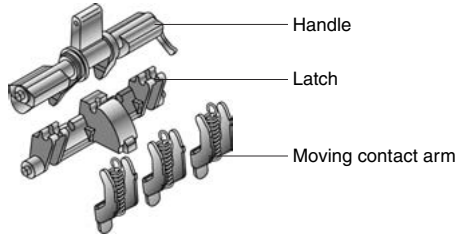

Contact opening distance/Moving contact arm torque

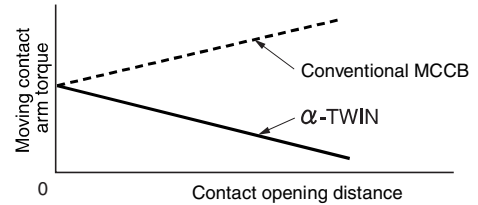

High-performance arc quenching chamber

The combination of the simple Flat Turn contact arm, blowout magnet, and arc-quenching chamber provided a unique current-limiting effect.

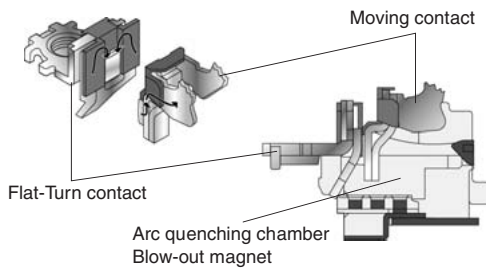

Structure of the arc-quenching chamber

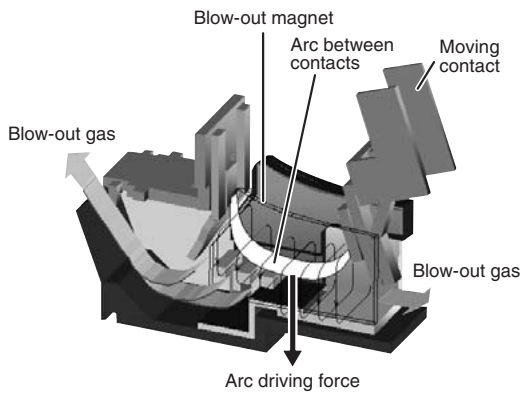

Comparison of arc voltages resulting from short-circuit current

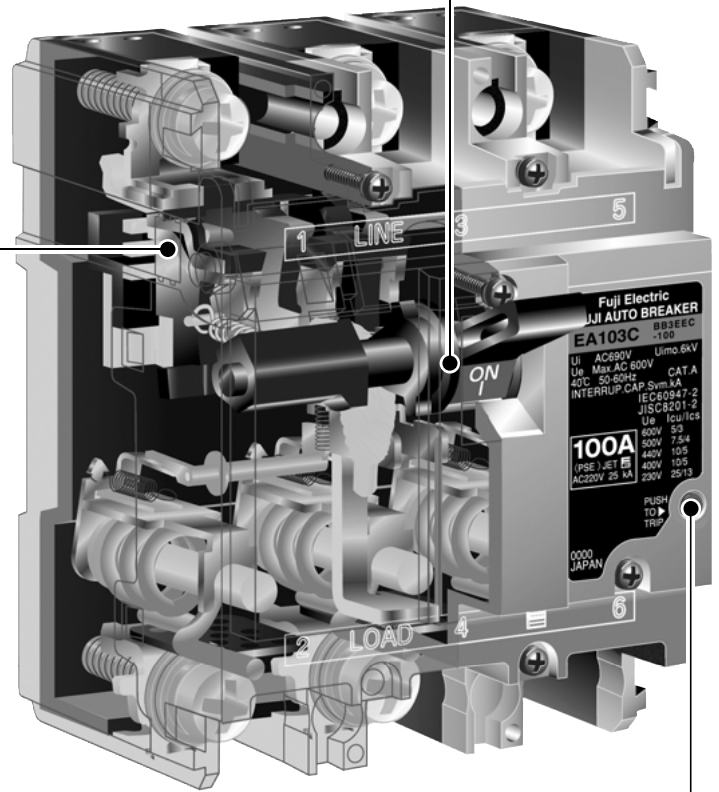
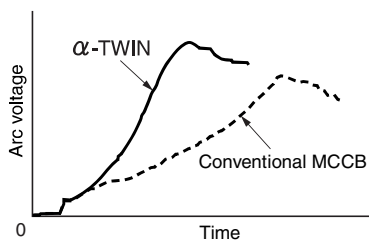

Trip button

The MCCB can be mechanically tripped externally.

Molded Case Circuit Breakers

Design features

Model configuration

Model configuration

Standardization of the main dimensions of the MCCB's has a large effect on panel design, manufacturing and appearance.

Modular construction

Standardized modular construction
30AF to 800AF α -TWIN Breakers standardized basic dimensions — panel design and cutouts are simplified for manufacturing cost savings. The number of mounting space sizes for the 30AF to 800AF S and E series models has been reduced to 5. New α -TWIN Breakers are available in two standard depths: 60 and 103mm, choose it from two front panel cutout height of 52mm or 92mm. The operating handle is at the center of the breaker and its panel cutout for eased panel design, manufacture, and mounting are easy. Terminal height above the panel of models 30AF to 225AF is standardized at 24mm to ease wiring.

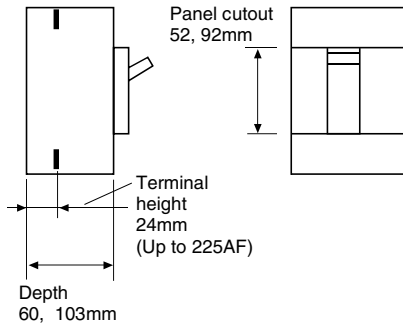

Side-by-side installation

A pole width of 25mm was selected for distribution panel breakers and economy type general-purpose breakers with frame size of 100A and smaller. Therefore, extremely rational procedures can be devised for panel machining and wiring.



Thin terminal block

The terminal block for internal accessory is now thinner (1/2 the size of conventional type). Thus, the space between breakers has been reduced to less than 1/3 that required by conventional type. (EA100AF or smaller)

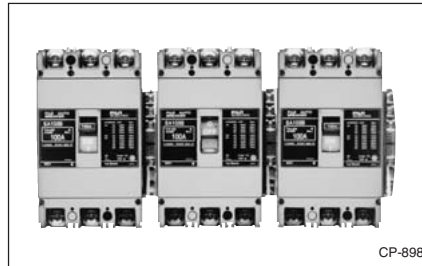

Compact and lightweight

These breakers are more compact and lightweight than those of the old series. Photos are a comparison of new EA103C breakers and old EA103B.

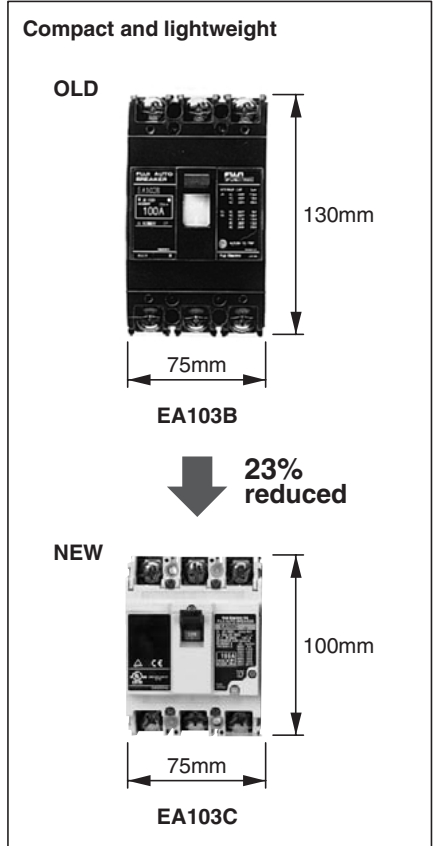

The standardization of depths reduces the number of frame sizes from 6 to 5.

Conventional series dimensions (30AF to 800AF)

						(mm)	
						60	96
EA30 EA50A EA100F	SA30B EA50B SA50B EA60B SA50R EA100B SA60B EA60R	SA100BA SA100RA	SA225BA EA225B SA225RA	SA400B EA400B SA400R	SA600R EA600B SA800R EA800B	60	130
						60	155
						60	165
						103	257
						103	275
α-TWIN series dimensions							
						60	100
SA30C EA30AC SA50C EA50AC SA50RC EA50C SA60C EA60C SA60RC EA100AC EA100C	SA103C EA103RC	SA225C EA225C SA225RC	SA400C EA400C SA400RC	SA600RC EA600C SA800RC EA800C		60	155
						60	165
						103	257
						103	275

Note : The figures show the dimensions of three-pole models

Molded Case Circuit Breakers

Design features

Terminal construction

■ Front mounting front connection

4 main types of terminals are as shown in the photos. Terminal screws are self-lifting, pan-head screw, hexagonal socket head screw and flat terminal which are tighten because bolts are used.

Terminals vary according to the current capacity of each type of housing. All breaker terminals should be connected to copper crimp connectors or copper bus bars. Never connect to aluminium conductors, since overheating can be expected.

Self-lifting terminal



Screw terminal (Pan-head bolt)

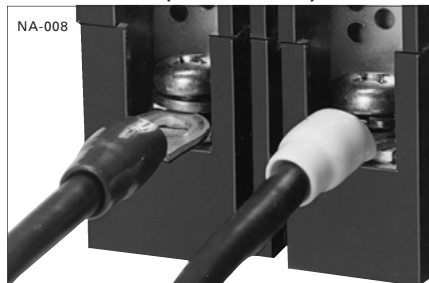

Screw terminal (Hexagonal socket head bolt)



Flat terminal

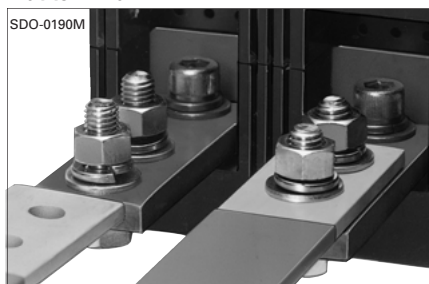

Terminal covers

Since the live conductors are exposed at the MCCB terminals there is the danger of accidental contact.

A terminal cover can be provided where necessary.

For further information refer to page 06 /128.

Short type

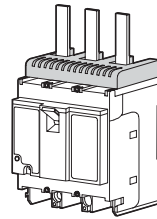

Long type

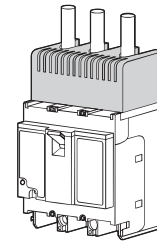

Modular design — Up to 225AF E and S series (α-TWIN series)

Since molded cases generally have common dimensions and outlines they can easily be installed on distribution boards in uniform neat groupings, with switches lined up in a row. E and S series up to 225AF are built on the modular system. For instance the depth is 60mm while the panel cutout height is 52mm. The standardization of the MCCBs and panel board allows the speed up of assembling and wiring of the panel and permits panel surface processing to be carried out in a shorter period of time.

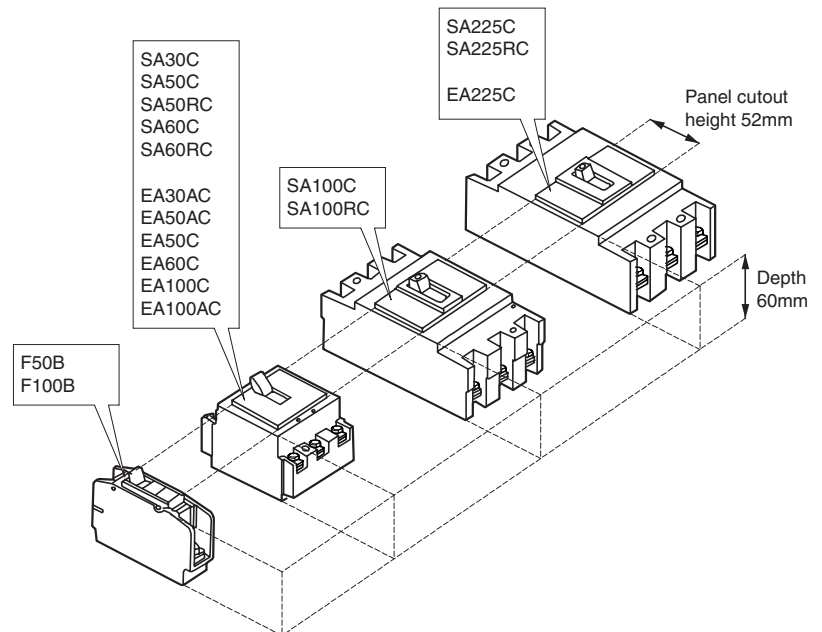

Molded Case Circuit Breakers

Design features

Accessories

■ Internal and external accessories A wider range of customer-mountable accessories

The range of cassette-type internal accessories has been greatly expanded for α -TWIN MCCBs. This speeds up and simplifies customer response to specification changes. All accessories shown here can be mounted by the customer except for motor operating mechanism and plate type padlocking device.

Wide variety of internal accessory combinations

Up to two auxiliary switches, two alarm switches, and one shunt trip device or undervoltage trip device quickly snap on or in.

Quick and easy mounting

No need to open breaker cover to mount accessories. Internal accessories easily snap into a pocket at the left of the breaker window frame.

No adjustments

Accessory mounting is quick and easy — accessories adjust automatically at the correct position when mounted.

Two ways to connect — lead wires or terminal blocks

• Lead wire types

Leads are marked with to indicate the correct terminal number of the accessory — incorrect wiring is minimized. To make wiring easy and prevent to incorrect connection, the lead wires are provided with color coated tube and marking on it.

• Terminal block types



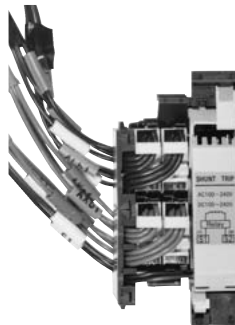



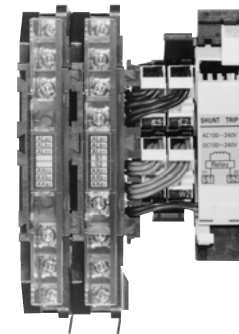

Terminal blocks are mounted on the side of the breaker case. Blocks are only 12.5 or 19mm thick, minimizing panel mounting space. Installed lead wires are parallel to the side of the case.

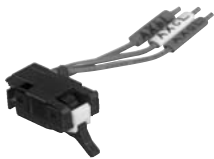

AF93-82

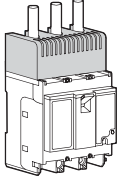
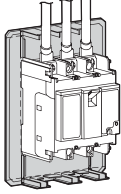
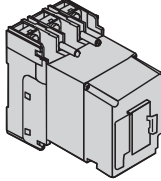
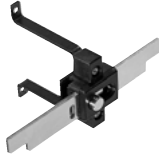

AF93-81

Alarm switch 	Auxiliary switch 	Shunt trip device 	Undervoltage trip device 	Terminal block 
Terminal covers Long type Short type 	Insulation barriers Interphase barrier Earth barrier 	Motor operating mechanism 	Mechanical interlocking device 	
Steel enclosure 	Handle padlocking device Handle locking cover 	Operating handles N type V type 	Modification kits For front mounting, rear connection For plug-in mounting For flush mounting, rear connection 	

Molded Case Circuit Breakers

Breaking capacities

■ IEC60947-2, JIS C8201-2 / IEC and CE marking conformed

Series	Breaker ampere frame	Basic type	Pole	Rated current (A)	Insulation voltage Ui (V)	Breaking capacity (kA)[Icu/lcs]									
						IEC60947-2					JIS C8201-2				
						AC	230V	380V	400V	415V	440V	500V	600V	DC	250V
S	30	SA32C□-CE	2	3, 5, 10, 15, 20, 30	690	5/3	2.5/2	2.5/2	2.5/2	2.5/2	2.5/2	1.5/1	–	2.5/2	
	30	SA33C□-CE	3	3, 5, 10, 15, 20, 30	690	5/3	2.5/2	2.5/2	2.5/2	2.5/2	2.5/2	1.5/1	–	2.5/2	
	50	SA52C□-CE	2	5, 10, 15, 20, 30, 40, 50	690	10/5	7.5/4	7.5/4	7.5/4	7.5/4	7.5/4	5/3	2.5/2	5/3	
	50	SA53C□-CE	3	5, 10, 15, 20, 30, 40, 50	690	10/5	7.5/4	7.5/4	7.5/4	7.5/4	7.5/4	5/3	2.5/2	5/3	
	50	SA52RC□-CE	2	10, 15, 20, 30, 40, 50	690	25/13	10/5	10/5	10/5	10/5	10/5	7.5/4	5/3	5/3	
	50	SA53RC□-CE	3	10, 15, 20, 30, 40, 50	690	25/13	10/5	10/5	10/5	10/5	10/5	7.5/4	5/3	5/3	
	60	SA62C□-CE	2	60	690	10/5	7.5/4	7.5/4	7.5/4	7.5/4	7.5/4	5/3	2.5/2	5/3	
	60	SA63C□-CE	3	60	690	10/5	7.5/4	7.5/4	7.5/4	7.5/4	7.5/4	5/3	2.5/2	5/3	
	60	SA62RC□-CE	2	60	690	25/13	10/5	10/5	10/5	10/5	10/5	7.5/4	5/3	5/3	
	60	SA63RC□-CE	3	60	690	25/13	10/5	10/5	10/5	10/5	10/5	7.5/4	5/3	5/3	
	100	SA102C□-CE	2	15, 20, 30, 40, 50, 60, 75, 100	690	50/25	30/8	30/8	30/8	30/8	25/7	15/4	–	15/8	
	100	SA103C□-CE	3	15, 20, 30, 40, 50, 60, 75, 100	690	50/25	30/8	30/8	30/8	30/8	25/7	15/4	–	15/8	
	100	SA102RC□-CE	2	15, 20, 30, 40, 50, 60, 75, 100	690	100/50	50/13	50/13	50/13	50/13	50/13	30/8	–	40/20	
	100	SA103RC□-CE	3	15, 20, 30, 40, 50, 60, 75, 100	690	100/50	50/13	50/13	50/13	50/13	50/13	30/8	–	40/20	
	225	SA202C□-CE	2	125, 150, 175, 200, 225	690	50/25	30/8	30/8	30/8	30/8	25/7	15/4	–	15/8	
	225	SA203C□-CE	3	125, 150, 175, 200, 225	690	50/25	30/8	30/8	30/8	30/8	25/7	15/4	–	15/8	
	225	SA202RC□-CE	2	125, 150, 175, 200, 225	690	100/50	50/13	50/13	50/13	50/13	50/13	30/8	–	40/20	
	225	SA203RC□-CE	3	125, 150, 175, 200, 225	690	100/50	50/13	50/13	50/13	50/13	50/13	30/8	–	40/20	
	400	SA402C□-CE	2	250, 300, 350, 400	690	50/25	35/18	35/18	35/18	35/18	35/18	22/11	–	20/10	
	400	SA403C□-CE	3	250, 300, 350, 400	690	50/25	35/18	35/18	35/18	35/18	35/18	22/11	–	20/10	
	400	SA402RC□-CE	2	250, 300, 350, 400	690	85/43	50/25	50/25	50/25	50/25	50/25	35/18	30/15	40/20	
	400	SA403RC□-CE	3	250, 300, 350, 400	690	85/43	50/25	50/25	50/25	50/25	50/25	35/18	30/15	40/20	
	600	SA603RC□-CE	3	500, 600	690	85/43	50/25	50/25	50/25	50/25	50/25	35/18	30/15	40/20	
	800	SA803RC□-CE	3	700, 800	690	85/43	50/25	50/25	50/25	50/25	50/25	35/18	30/15	40/20	
E	30	EA32AC□-CE	2	3, 5, 10, 15, 20, 30	500	2.5/2	1.5/1	1.5/1	1.5/1	1.5/1	1.5/1	–	–	–	
	30	EA33AC□-CE	3	3, 5, 10, 15, 20, 30	500	2.5/2	1.5/1	1.5/1	1.5/1	1.5/1	1.5/1	–	–	–	
	50	EA52AC□-CE	2	5, 10, 15, 20, 30, 40, 50	500	2.5/2	1.5/1	1.5/1	1.5/1	1.5/1	1.5/1	–	–	–	
	50	EA53AC□-CE	3	5, 10, 15, 20, 30, 40, 50	500	2.5/2	1.5/1	1.5/1	1.5/1	1.5/1	1.5/1	–	–	–	
	50	EA52C□-CE	2	5, 10, 15, 20, 30, 40, 50	690	5/3	2.5/2	2.5/2	2.5/2	2.5/2	2.5/2	1.5/1	–	2.5/2	
	50	EA53C□-CE	3	5, 10, 15, 20, 30, 40, 50	690	5/3	2.5/2	2.5/2	2.5/2	2.5/2	2.5/2	1.5/1	–	2.5/2	
	60	EA62C□-CE	2	60	690	5/3	5/3	2.5/2	2.5/2	2.5/2	2.5/2	1.5/1	–	2.5/2	
	60	EA63C□-CE	3	60	690	5/3	5/3	2.5/2	2.5/2	2.5/2	2.5/2	1.5/1	–	2.5/2	
	100	EA103AC□-CE	3	60, 75, 100	500	5/3	1.5/1	1.5/1	–	–	–	–	–	–	
	100	EA102C□-CE	2	50, 60, 75, 100	690	25/13	10/5	10/5	10/5	10/5	10/5	7.5/4	5/3	5/3	
	100	EA103C□-CE	3	50, 60, 75, 100	690	25/13	10/5	10/5	10/5	10/5	10/5	7.5/4	5/3	5/3	
	225	EA202C□-CE	2	125, 150, 175, 200, 225	690	35/18	18/5	18/5	18/5	18/5	15/4	10/3	–	10/5	
	225	EA203C□-CE	3	125, 150, 175, 200, 225	690	35/18	18/5	18/5	18/5	18/5	15/4	10/3	–	10/5	
	400	EA402C□-CE	2	250, 300, 350, 400	690	35/18	25/13	25/13	25/13	25/13	25/13	18/9	–	20/10	
	400	EA403C□-CE	3	250, 300, 350, 400	690	35/18	25/13	25/13	25/13	25/13	25/13	18/9	–	20/10	
	600	EA603C□-CE	3	500, 600	690	50/25	35/18	35/18	35/18	35/18	35/18	22/11	–	20/10	
	800	EA803C□-CE	3	700, 800	690	50/25	35/18	35/18	35/18	35/18	35/18	22/11	–	20/10	

Note: For details of breaking capacity, see page 06/10 "Quick reference guide".

Series	Breaker ampere frame	Basic type	Pole	Rated current (A)	Insulation voltage Ui (V)	Breaking capacity (kA)[Icu/lcs]					DC 250V
						IEC60947-2					
						AC	230V	400V	440V	500V	600V
S	1000	SA1003E	3	500-600-700-800-900-1000	690	100/75	65/49	65/49	45/34	25/19	–
		SA1004E	4	500-600-700-800-900-1000	690	100/75	65/49	65/49	45/34	25/19	–
	1200	SA1203E	3	600-700-800-1000-1200	690	100/75	65/49	65/49	45/34	25/19	–
		SA1204E	4	600-700-800-1000-1200	690	100/75	65/49	65/49	45/34	25/19	–
	1600	SA1603E	3	800-900-1000-1200-1400-1600	690	125/94	85/64	85/64	65/49	45/34	–
		SA1604E	4	800-900-1000-1200-1400-1600	690	125/94	85/64	85/64	65/49	45/34	–

Molded Case Circuit Breakers

Breaking capacities

■ JIS C8370

Series	Breaker ampere frame	Basic type	Pole	Rated current (A)	Insulation voltage Ui (V)	Breaking capacity (kA)							
						AC							
						220V	240V	380V	415V	500V	600V	660V	
H	100	H103R	3	40, 50, 60, 75, 100	660	125	125	100	85	42	35	–	40
	225	H203R	3	125, 150, 175, 200, 225	660	125	125	100	85	42	35	–	40

Series	Breaker ampere frame	Basic type	Pole	Rated current (A)	Insulation voltage Ui (V)	Breaking capacity (kA)							
						AC							
						220V	240V	380V	415V	500V	600V	660V	
S	50	SA54B	4	5, 10, 15, 20, 30, 40, 50	660	10	10	7.5	7.5	5	2.5	–	–
	100	SA104R	4	15, 20, 30, 40, 50, 60, 75, 100	660	85	85	50	45	35	25	–	–
	225	SA204R	4	125, 150, 175, 200, 225	660	85	85	50	50	35	25	–	–
	400	SA404HA	4	250, 300, 350, 400	660	85	85	45	45	35	30	–	–
	600	SA604H	4	500, 600	660	85	85	45	45	35	30	–	–
	800	SA804H	4	700, 800	660	85	85	45	45	35	30	–	–
	1000	S1004	4	1000	660	85	85	50	50	35	30	30	–
	1200	S1204	4	1200	660	85	85	50	50	35	30	30	–
E	100	EA104B	4	50, 60, 75, 100	660	25	25	15	10	7.5	5	–	–
F	50	F51B	1	15, 20, 30, 40, 50	300	2.5	3	–	3	–	–	–	–
	50	F52B	2	15, 20, 30, 40, 50	300	5	3	–	3	–	–	–	–
	50	F53B	3	15, 20, 30, 40, 50	300	5	3	–	–	–	–	–	–
	100	F102B	2	60, 75, 100	300	5.5	3	–	–	–	–	–	–
	100	F103B	3	60, 75, 100	300	5.5	3	–	–	–	–	–	–

Molded Case Circuit Breakers

Breaking capacities

■ IEC 60947-2

Series	Breaker ampere frame	Basic type	Pole	Rated current (A)	Insulation voltage Ui (V)	Breaking capacity (kA)[Icu/lcs] IEC60947-2					
						AC 230V	400V	440V	500V	600V	DC 250V
L	50	LA53B	3	5, 10	660	100/50	60/30	50/25	42/21	–	–
H	50	H52BA	2	15, 20, 30, 40, 50	690	125/32	65/17	65/17	35/9	25/7	40/10
	50	H53BA	3	15, 20, 30, 40, 50	690	125/32	65/17	65/17	35/9	25/7	40/10
	100	H102BA	2	15, 20, 30, 40, 50, 60, 75, 100	690	125/32	65/17	65/17	35/9	25/7	40/10
	100	H103BA	3	15, 20, 30, 40, 50, 60, 75, 100	690	125/32	65/17	65/17	35/9	25/7	40/10
	225	H202BA	2	125, 150, 175, 200, 225	690	125/32	65/17	65/17	35/9	25/7	40/10
	225	H203BA	3	125, 150, 175, 200, 225	690	125/32	65/17	65/17	35/9	25/7	40/10
	400	H402B	2	250, 300, 350, 400	690	125/63	65/33	65/33	42/21	35/18	40/20
	400	H403B	3	250, 300, 350, 400	690	125/63	65/33	65/33	42/21	35/18	40/20
	400	H403R	3	250, 300, 350, 400	690	125/63	125/63	125/63	85/43	–	40/20
	600	H603B	3	500, 600	690	125/63	65/33	65/33	42/21	35/18	40/20
	600	H603R	3	500, 600	690	125/63	125/63	125/63	85/43	–	40/20
	800	H803B	3	700, 800	690	125/63	65/33	65/33	42/21	35/18	40/20
	800	H803R	3	700, 800	690	125/63	125/63	125/63	85/43	–	40/20

■ UL489 Listed

Series	Breaker ampere frame	Basic type	Pole	Rated current (A)	Insulation voltage Ui (V)	Breaking capacity (kA)[Icu/lcs] IEC60947-2 JIS C8201-2										UL489 (cUL)		
						AC		IEC60947-2						JIS C8201-2		Rated voltage (V)	Breaking capacity (kA)	
						230V	380V	400V	415V	440V	500V	600V	250V	240	480Y/277	480		
S	50	SA52RCUL	2	3, 5, 10, 15, 20, 30, 40, 50	690	25/13	10/5	10/5	10/5	10/5	7.5/4	5/3	–	240	14	–	–	
	50	SA53RCUL	3	3, 5, 10, 15, 20, 30, 40, 50	690	25/13	10/5	10/5	10/5	10/5	7.5/4	5/3	–	240	14	–	–	
	100	SA102CUL	2	15, 20, 30, 40, 50, 60, 70, 75, 80, 90, 100	690	50/25	30/8	30/8	30/8	25/7	15/4	–	15/8	240	35	–	–	
	100	SA103CUL	3	15, 20, 30, 40, 50, 60, 70, 75, 80, 90, 100	690	50/25	30/8	30/8	30/8	25/7	15/4	–	15/8	240	35	–	–	
	100	SA102RCUL	2	15, 20, 30, 40, 50, 60, 70, 75, 80, 90, 100	690	100/50	50/13	50/13	50/13	50/13	30/8	–	40/20	480Y/277	85	25	–	
	100	SA103RCUL	3	15, 20, 30, 40, 50, 60, 70, 75, 80, 90, 100	690	100/50	50/13	50/13	50/13	50/13	30/8	–	40/20	480Y/277	85	25	–	
	225	SA202CUL	2	125, 150, 175, 200, 225	690	50/25	30/8	30/8	30/8	25/7	15/4	–	15/8	240	35	–	–	
	225	SA203CUL	3	125, 150, 175, 200, 225	690	50/25	30/8	30/8	30/8	25/7	15/4	–	15/8	240	35	–	–	
	225	SA202RCUL	2	125, 150, 175, 200, 225	690	100/50	50/13	50/13	50/13	50/13	30/8	–	40/20	480Y/277	85	25	–	
	225	SA203RCUL	3	125, 150, 175, 200, 225	690	100/50	50/13	50/13	50/13	50/13	30/8	–	40/20	480Y/277	85	25	–	
	400	SA402CUL	2	250, 300, 350, 400	690	50/25	35/18	35/18	35/18	35/18	22/11	–	20/10	480	42	25	25	
	400	SA403CUL	3	250, 300, 350, 400	690	50/25	35/18	35/18	35/18	35/18	22/11	–	20/10	480	42	25	25	
	400	SA402RCUL	2	250, 300, 350, 400	690	85/43	50/25	50/25	50/25	50/25	35/18	30/15	40/20	480	85	50	50	
	400	SA403RCUL	3	250, 300, 350, 400	690	85/43	50/25	50/25	50/25	50/25	35/18	30/15	40/20	480	85	50	50	
	600	SA603RCUL	3	500, 600	690	85/43	50/25	50/25	50/25	50/25	35/18	30/15	40/20	480	85	50	50	
	800	SA803RCUL	3	700, 800	690	85/43	50/25	50/25	50/25	50/25	35/18	30/15	40/20	480	85	50	50	
	E	100	EA102CUL	2	60, 70, 75, 80, 90, 100	690	25/13	10/5	10/5	10/5	10/5	7.5/4	5/3	–	240	14	–	–
		100	EA103CUL	3	60, 70, 75, 80, 90, 100	690	25/13	10/5	10/5	10/5	10/5	7.5/4	5/3	–	240	14	–	–

Molded Case Circuit Breakers

Quick reference guide

Line protection

■ S series/4-pole

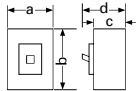
Frame		50A	100A	225A
Pole		4	4	4
Type		SA54B	SA104R	SA204R
Rated current (Amps) Ambient temp.: 40°C for general use		5, 10, 15, 20 30, 40, 50	15, 20, 30, 40 50, 60, 75, 100	125, 150, 175 200, 225
Rated insulation voltage Ui (Volts) AC		660	660	660
Rated breaking capacity (kA)	JIS C8370 sym	550V AC 460V AC 220V AC	2.5 7.5 10	35 42 85
Dimensions (mm)		a b c d	100 130 60 80	120 155 82 104
Mass (kg) Front mounting type		0.8	1.9	2.5
Tripping device		Hydraulic-magnetic	Thermal-magnetic	Thermal-magnetic
Trip button		Provided	Provided	Provided
Front mounting, front connection	No-mark	●	●	●
Front mounting, rear connection	X	●	●	●
Flush mounting, rear connection	E	●	●	●
Flush mounting, top & bottom connection	Y	●	—	—
Plug-in mounting	P	—	—	—
Draw-out	D	—	—	—
Internal accessories		<i>Page 06/88</i>		
Alarm switch	K	BZ-K23B□	BZ-K35B□	BZ-K50B
Auxiliary switch	W	BZ-W23B□	BZ-W35B□	BZ-W50B
Undervoltage trip	R	—	—	—
Shunt trip	F	BZ-F23BT □	BZ-F35BT □	BZ-F50BT □
External accessories				
Motor operating mechanism	M	—	▲	▲
Padlocking device	Q	▲	▲	▲
Mechanical interlocking device	M1	BZ-M120C-4	BZ-M135C-4	BZ-M150C-4
Operating handle N type	N	BZ-N20C	BZ-N35B	BZ-N50B
Operating handle V, G type	V, G	BZ-V20C	BZ-G35C	BZ-G50C
Steel enclosure	C	—	—	—
Steel enclosure with V type handle	CV	—	—	—
Terminal cover Short	TS	BZ-TS20B-4	—	—
Terminal cover Long	TB	BZ-TB20B-4	BZ-TB35B-4	BZ-TB45B-4
Insulation barrier Interphase	B	—	—	—
Insulation barrier Earth	BL	—	—	—

Notes: • Handlelock cover is supplied on request (sold separately)

● Available — Not available ▲ Factory-mounted accessory

■ S series/4-pole

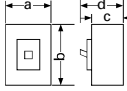
Frame	400A		600A	800A
Pole	4		4	4
Type	<i>Page 06/43</i> SA404HA		SA604H	SA804H
Rated current (Amps) Ambient temp.: 40°C for general use	250, 300 350, 400		500, 600	700, 800
Rated insulation voltage Ui (Volts) AC	660		660	660
Rated breaking capacity (kA)	JIS C8370 sym	550V AC 35 460V AC 42 220V AC 85	35 42 85	35 42 85
Dimensions (mm)		a 185 b 257 c 103 d 134	280 275 103 149	280 275 103 149
<i>Page 06/57</i>				
Mass (kg)	Front mounting type		7.5	17.0
Tripping devices			Thermal-magnetic	Thermal-magnetic
Trip button			Provided	Provided
Front mounting, front connection	No-mark	●	●	●
Front mounting, rear connection	X	●	●	●
Flush mounting, rear connection	E	●	●	●
Flush mounting, top & bottom connection	Y	—	—	—
Plug-in mounting	P	—	—	—
Draw-out	D	—	—	—
Internal accessories	<i>Page 06/88</i>			
Alarm switch	K	▲	▲	▲
Auxiliary switch	W	▲	▲	▲
Undervoltage trip	R	▲	▲	▲
Shunt trip	F	▲	▲	▲
External accessories				
Motor operating mechanism	M	▲	▲	▲
Padlocking device	Q	▲	▲	▲
Mechanical interlocking device	M1	BZ-M144	BZ-M154	BZ-M154
Operating handle N type	N	N-23A	N-41A	N-41A
Operating handle G type	G	G-22A	G-42A	G-42A
Steel enclosure	C	—	—	—
Steel enclosure with G type handle	CG	—	—	—
Terminal cover Inside panel use	A1	—	—	—
Terminal cover Outside panel use	T1	—	—	—
Insulation barrier Interphase	B	B-44A	B-44A	B-44A
Insulation barrier Earth	BL	—	—	—

Notes: *1 Specify the frequency when ordering circuit breaker for AC circuit.
Contact FUJI for DC circuit.

● Available — Not available ▲ Factory-mounted accessory

• Handlelock cover is supplied on request (sold separately)

■ E series/3-pole IEC and CE marking conformed types

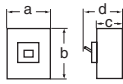
Frame	800A	
Pole	3	
Type	Page 06/42	EA803C□-CE
Rated current (A)	700, 800	
Rated insulation voltage (V AC)	690	
[IEC 60947-2, JIS C8201-2] (V DC)	250	
Rated breaking capacity (kA)	600V AC	—
[IEC 60947-2, JIS C 8201-2] (Icu/Ics) *1	500V AC	22/11
	440V AC	35/18
	415V AC	35/18
	400V AC	35/18
	380V AC	35/18
	230V AC	50/25
	250V DC	20/10
Rated operating voltage [UL508] (V AC)	—	
Dimensions (mm)	a	210
	b	275
	c	103
	d	146
Page 06/66		
Mass (kg) Front mounting type	10	
Tripping device	Thermal-magnetic	
Front mounting, front connection	No-mark	●
Front mounting, rear connection	X	●
Flush mounting, rear connection	E	●
Flush mounting, top & bottom connection	Y	—
Plug-in mounting	P	●
IEC 35mm wide rail mounting	—	—
Internal accessories	Page 06/88	
Alarm switch	K	BZ-K70B
Alarm switch with terminal block	KA	BZ-K70BA
Auxiliary switch	W	BZ-W70B
Auxiliary switch with terminal block	WA	BZ-W70BA
Undervoltage trip	R	BZ-R70B-□
Shunt trip	F	BZ-F70B-□
Shunt trip with terminal block	FA	BZ-F70BA-□
External accessories		
Motor operating mechanism	M	▲
Handle padlocking device Cap type	Q1	▲
Plate type	Q2	▲
Mechanical interlocking device	M1	BZ-M170C
	M2	BZ-M270C
	M3	BZ-M370C
Operating handle N-type	N	BZ-N70C
Operating handle V-type	V	BZ6V70C
Steel enclosure Direct operating	C	BZ-C70B
Dustproof steel enclosure Handle operating	CV	BZ-CV70C
Rainproof steel enclosure Handle operating	CW	—
Terminal cover Short	TS	—
Terminal cover Long	TB	BZ-TB70B
Insulation barrier Interphase *2	B	B-43A
Insulation barrier Earth	BL	—
Handle locking cover	L	BZ-L70B
Flat terminal	S	—

Notes: *1 Icu: Rated ultimate short-circuit breaking capacity
Ics: Rated service short-circuit breaking capacity
*2 Interphase insulation barriers are standard provided for the front mounting type breakers.

■ E series/4-pole

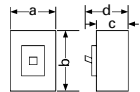
Frame	100A	
Pole	4	
Type	Page 06/47	EA104B
Rated current (Amps)	50, 60, 75, 100	
Ambient temp.:	40°C for general use	
Rated insulation voltage Ui (Volts)	AC	660
	DC	—
Rated breaking capacity (kA)	JIS C8370 sym	550V AC 7.5 460V AC 10 220V AC 25 250V DC —
Dimensions (mm)		a 100 b 130 c 60 d 80
Page 06/66		
Mass (kg)	Front mounting type	1.0
Tripping device	Hydraulic-magnetic	
Trip button	Provided	
Front mounting, front connection	No-mark	●
rear connection	X	●
Flush mounting, rear connection	E	●
top & bottom connection	Y	●
Plug-in mounting	P	—
Draw-out	D	—
Internal accessories	Page 06/88	
Alarm switch	K	BZ-K25B□
Auxiliary switch	W	BZ-W25B□
Undervoltage trip	R	—
Shunt trip	F	BZ-F25BT
External accessories		
Motor operating mechanism	M	—
Padlocking device	Q	▲
Mechanical interlocking device	M1	BZ-M120C-4
Operating handle N type	N	BZ-N20C
Operating handle V type	V	BZ-V20C
Steel enclosure	C	—
Steel enclosure with V type handle	CV	—
Terminal cover Short	TS	BZ-TS20B-4
Terminal cover Long	TB	BZ-TB20B-4
Insulation barrier Interphase	B	—
Insulation barrier Earth	BL	—

● Available — Not available ▲ Factory-mounted accessory

Molded Case Circuit Breakers

Mounting modifications

■ Mounting modifications



Standard type FUJI breakers are front mounting with front connections. The standard breaker can easily be modified to become front mounting rear connection type, flush mounting type and plug-in type. The additional parts such as insulation bases, barriers, covers and similar parts are added as required.

Standard type
Front mounting
Front connection



BASIC DESIGN

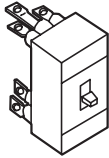
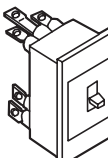
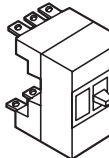
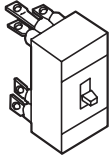
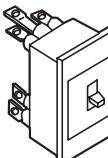
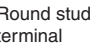
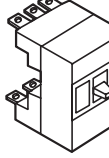

Mounting modification kits:
 See page 06/130

Additional main parts	Front mounting Rear connection (X type)	Additional main parts	Flush mounting Rear connection (E type)	Additional main parts	Plug-in mounting (P type)
 Bar stud terminal	SA30C EA30AC SA50C EA50C SA50RC EA50AC SA60C EA60C SA60RC EA100C EA100AC	 Bar stud terminal	SA30C EA30AC SA50C EA50C SA50RC EA50AC SA60C EA60C SA60RC EA100C EA100AC	 Bar stud terminal	SA30C EA30AC SA50C EA50C SA50RC EA50AC SA60C EA60C SA60RC EA100C EA100AC
 Bar stud terminal	SA100C EA225C SA100RC EA400C SA225C EA600C SA225RC EA800C SA400C SA400RC SA600RC SA800RC	 Bar stud terminal	SA100C EA225C SA100RC EA400C SA225C EA600C SA225RC EA800C SA400C SA400RC SA600RC SA800RC	 Round stud terminal	SA100C SA100RC
	Each stud can be turned by 90°		Each stud can be turned by 90°		
		Additional main parts	Flush mounting Top and bottom connection (Y type)	 Bar stud terminal	SA225C EA225C SA225RC EA400C SA400C EA600C SA400RC EA800C SA600RC SA800RC
		 Decorative flush plate	SA30C EA30AC SA50C EA50C SA50RC EA50AC SA60C EA60C SA60RC EA100C EA100AC		Each stud can be turned by 90°

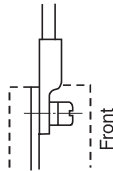
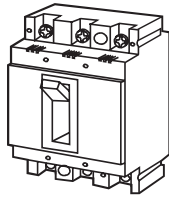
■ Terminal connection/Front mounting, front connection



Flat terminal

Self lifting screw	Breaker type	Size
	SA30C EA30AC SA50C EA50AC SA50RC EA50C	M5 × 14
	SA60C EA60C SA60RC EA100AC EA100C	M8 × 15

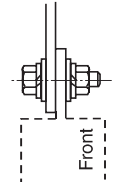
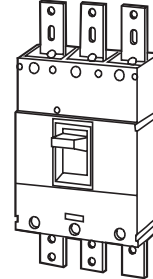
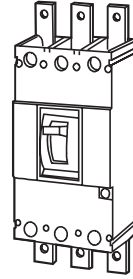

Flat terminal

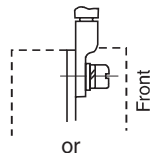
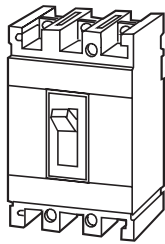

Hexagonal head bolt	Breaker type	Size
	SA400C EA400C SA400RC	M12 × 35
	SA600RC EA600C SA800RC EA800C	M12 × 40

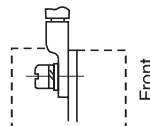

or



Flat terminal

Self lifting screw	Breaker type	Size
	SA100C SA100RC	M8 × 14
	SA225C EA225C SA225RC	M8 × 16

Type of connection/up to 225AF

Front mounting front connection

Direct connection

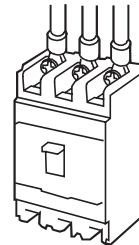
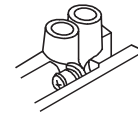

Flat terminal connection

Flat terminals are required.

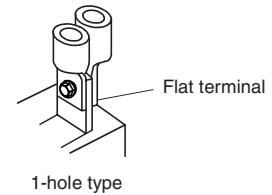

Flat bar studs/1-hole type

Breaker type	Pole	Type of flat terminal
SA30C, SA50C, SA50RC EA30AC, EA50AC, EA50C	2 3	BZ6S10C502 BZ6S10C503
SA60C, SA60RC EA60C, EA100C *	2 3	BZ6S10C1002 BZ6S10C1003
SA100C, SA100RC	2 3	BZ-S35B-1002 BZ-S35B-1003
SA225C, SA225RC EA225C	2 3	BZ-S50B-2252 BZ-S50B-2253

* EA100C breaker of rated current 50A: BZ6S10C502 or 503.

Molded Case Circuit Breakers

Wire size and terminal

■ Wire size and crimp terminal

The following is the size recommendations for crimp terminals.

Crimp terminal R : JIS C2805
 CB : JEM-1399
 JST : Product of Japan Crimp Terminal Co., Ltd.
 F : FUJI special crimp terminal

Ampere frame	Breaker	Wire size(mm ²)											
		1.04 2.63	2.63 6.64	6.64 10.52	10.52 16.78	16.78 26.66	26.66 42.42	42.42 60.57	60.57 96.3	96.3 117.2	117.2 152.05	152.05 192.6	192.6 242.27
30	EA30AC SA30C	R2-5	R5.5-5	R8-5	R14-5								
50	SA50C, SA50RC EA50AC, EA50C LA50B	R2-5	R5.5-5	R8-5	R14-5								
	H50BA	R2-8	R5.5-8	R8-8	R14-8	JST22-S8							
60	SA60C, SA60RC EA60C	R2-8	R5.5-8	R8-8	R14-8	JST22-S8							
100	SA100C, SA100RC H100BA, H100R	R2-8	R5.5-8	R8-8	R14-8	R22-8	JST38-S8	CB60-8					
	EA100AC EA100C	R2-8	R5.5-8	R8-8	R14-8	JST22-S8	JST38-S8	F60-8					
225	EA225C SA225C, SA225RC H225BA, H225R				R14-8	R22-8	R38-8	R60-8	CB100-8	CB150			
400	SA400C, SA400RC EA400C H400B, H400R						R38-12	R60-12	R100-12	R150-12	R200-12	JST325-12	
600	SA600RC EA600C H600B, H600R								R100-12	R150-12	R200-12	JST325-12	
800	SA800RC EA800C H800B, H800R								R100-12	R150-12	R200-12	JST325-12	
1000 1200	SA1000E SA1200E								R100-12	R150-12	R200-12	JST325-12	
1600	SA1600E								R100-12	R150-12	R200-12	JST325-12	

Note: For solid-state trip types, same as the standard types.

Block terminal connection (For UL Listed)

MCCB type	Rated current (A)	Connectable wire size	Tightening torque (N·m)	Type of screw head and size (mm)
SA100CUL SA100RCUL	15	14AWG	5.8 (5.8 to 6.4)	Slotted head screw
	20	12AWG		
	30	10AWG		
	40	8AWG		
	45	8AWG		
	50	8AWG		
	60	6AWG		
	75	4AWG		
SA225CUL SA225RCUL	100	3AWG	23 (23 to 25.3)	Hexagonal socket head bolt 6.35mm (1/4 inch)
	125	1AWG		
	150	1/0AWG		
	175	2/0AWG		
	200	3/0AWG		
SA400CUL SA400RCUL	225	4/0AWG	43.5 (43.5 to 48)	Hexagonal socket head bolt 9.53mm (3/8 inch)
	250	250kcmil		
	300	350kcmil		
	350	500kcmil		
SA600RCUL	400	3/0AWG x2	31.9 (31.9 to 35.1)	Hexagonal socket head bolt 8mm (5/16 inch)
	500	250-500kcmil x2		
SA800RCUL	600	250-500kcmil x2	31.07 (31.07 to 34.2)	
	700	250-500kcmil x2		
	800	3/0AWG-300kcmil x3		







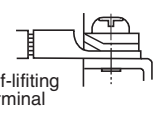
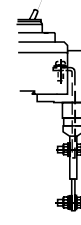
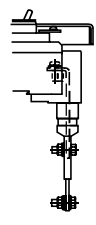
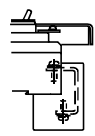
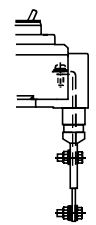
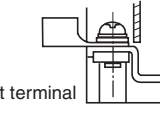

Notes: • AWG is abbreviation of "American Wire Gauge" and the UL approved wire unit.
 • The allowable temperature of wire is 75°C. (UL CSA approved)

Crimp terminal connection (For UL Listed)

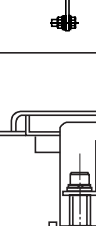
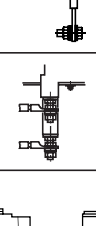
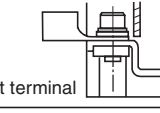
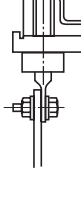
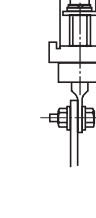
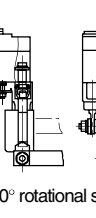
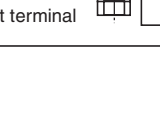
MCCB type	Rated current (A)	Applicable crimp terminal								Connectable wire size (AWG)		Tightening torque (N·m)	Type of screw head and size (mm)
		J.S.T. Mfg. Co., Ltd		Aikoku Kogyo K.K.		Nichifu Co., Ltd.		Daido Solderless Terminal Mfg. Co., Ltd.		60°C wire	75°C wire		
		60°C wire	75°C wire	60°C wire	75°C wire	60°C wire	75°C wire	60°C wire	75°C wire				
SA50RCUL	3		R2-5		R2-5						14AWG	2.3-2.8	Cross-recessed pan-head screw M5 x 14
	5												
	10												
	15												
	20		R5.5-5		R5.5-5						12AWG		
	30										10AWG		
	40		R8-5		R8-5						8AWG		
EA100CUL	60		R14-8		R14-8						6AWG	5.5-7.5	Cross-recessed pan-head screw M8 x 14
	75		22-S8		22-8						4AWG		
	100		38-S8		38-8S						3AWG		
SA100CUL	30	R5.5-8	R5.5-8	R5.5-8	R5.5-8	R5.5-8	R5.5-8	R5.5-8	R5.5-8	10AWG	10AWG	5.8 (5.3-6.4)	Cross-recessed pan-head screw M8 x 14
SA100RCUL	40	R8-8	R8-8	R8-8	R8-8	R8-8	R8-8	R8-8	R8-8	8AWG	8AWG		
	45	R14-8	R14-8	R14-8	R14-8	R14-8	R14-8	R14-8	R14-8	6AWG	6AWG		
	50												
	60	22-S8		22-8		22-8S		22-8S		4AWG	4AWG		
	70		22-S8		22-8		22-8S		22-8S		4AWG		
	75							38-8S		3AWG	3AWG		
	80												
90	38-S8	38-S8	38-8S	38-8S	38-8S	38-8S		38-8S	2AWG	3AWG			
100									1AWG	1AWG			
SA225CUL	125		38-S8		38-8S		R38-8S		38-8S		1AWG	10.5 (8-13)	Hexagonal socket head bolt M8 x 16
SA225RCUL	150		R60-8		R60-8		R60-8		60-8		1/0AWG		
	175		70-8				R70-8		70-8		2/0AWG		
	200		CB80-S8						CB80-S8		3/0AWG		
	225		CB100-S8						CB100-S8		4/0AWG		

Notes: • AWG is abbreviation of "American Wire Gauge" and the UL approved wire unit.
• The allowable temperature of wire is 75°C. (UL CSA approved)

Breaker termination

MCCB type	Front connection	Rear connection X	Flush mounting E	Y	Plug-in mounting P
SA30AC, SA50C, SA50RC EA30AC, EA50C, EA50AC	 Self-lifting terminal				
SA60C, SA60RC EA60C, EA100C, EA100AC	 Flat terminal				
SA100C, SA100RC	 Flat terminal				
SA225C, SA225RC EA225C	 Flat terminal				
SA400C, SA400RC SA600RC, SA800RC EA400C, EA600C, EA800C	 Flat terminal				 90° rotational stud

Molded Case Circuit Breakers

Type number nomenclature

■ Type number nomenclature

● IEC and CE marking conformed / Up to 800AF

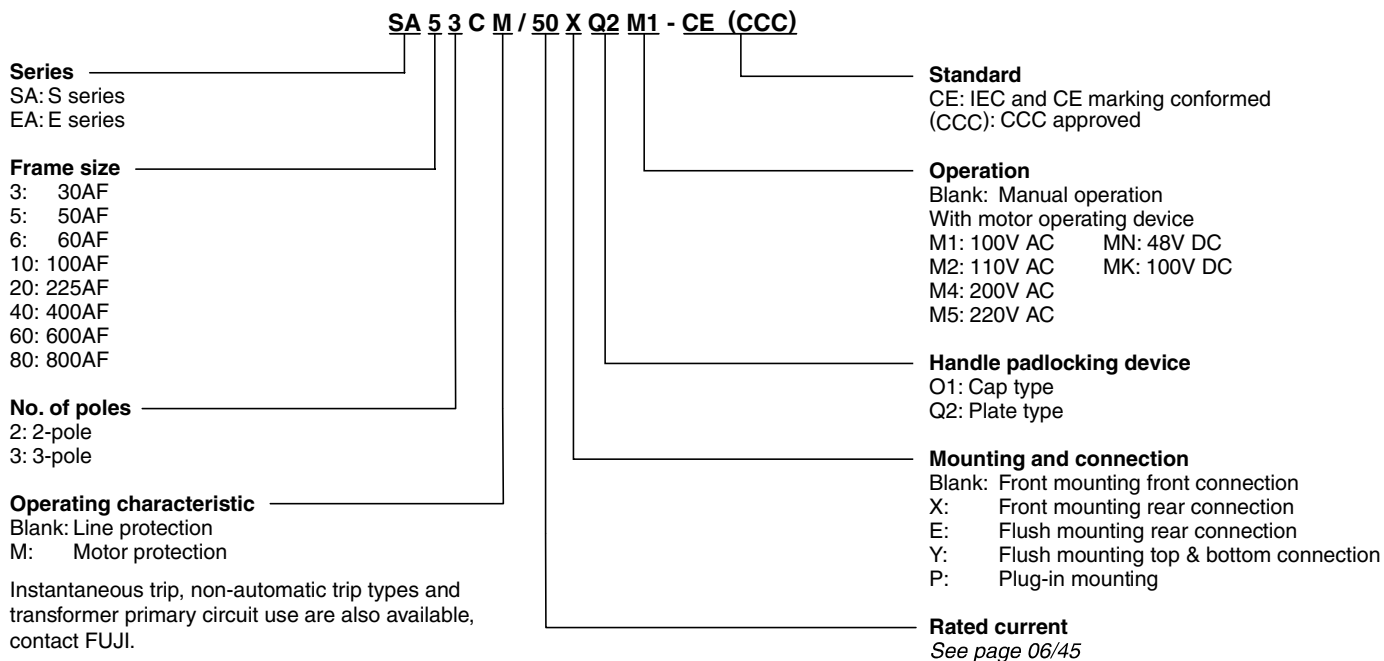

■ Ordering information

Specify the following:

1. Type number of MCCB including factory-mounted optional accessories
2. Type number of customer-mountable optional accessories

■ Customer-mountable optional accessories/Sold separately

Internal accessories

Auxiliary switch, alarm switch, shunt trip device, undervoltage trip device (except for SA100, SA225, EA225), terminal block

External accessories

Operating handles (N and V-type), terminal covers, insulation barrier, steel enclosures, handle locking covers, kits for mounting modification, flat terminal, mechanical interlock device

■ Factory-mounted accessories

External accessories

Handle padlocking devices/Q1 and Q2, motor-operating mechanism/M, under voltage trip device for SA100, SA225 and EA225 only

Further information: See page 06/88.

• Example

S series	SA
3-pole, 660V, 100A Frame	103C
Rated current 75A	75
Front mounting, front connection	Blank
IEC and CE marking conformed	CE

Complete type number

SA103C/75-CE

■ Type number nomenclature

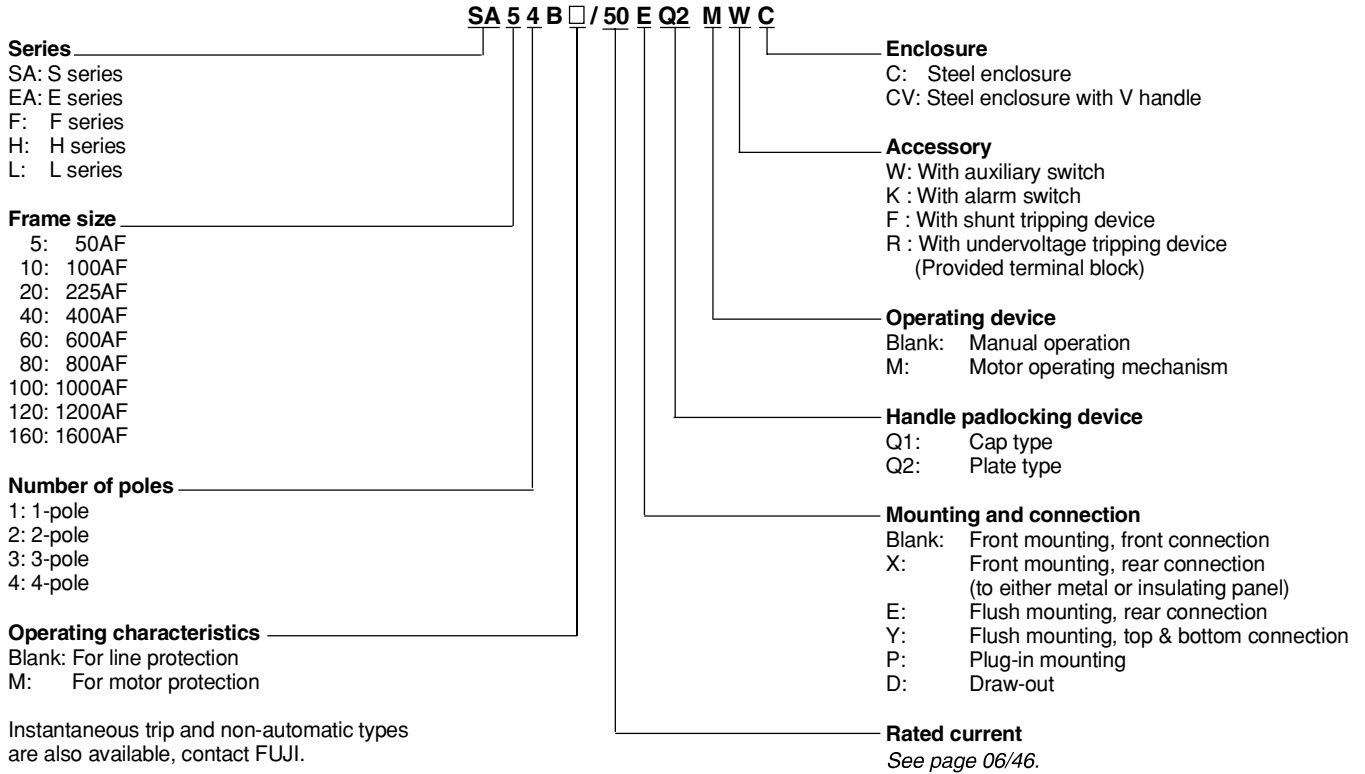

■ Ordering information

Specify the following:

1. Type number
2. Optional accessories
Lead wire or terminal block connection
3. When ordering MCCB with shunt tripping device, undervoltage tripping device or motor operating mechanism, specify rated voltage and frequency.
4. Handle type if required

Molded Case Circuit Breakers

Type number nomenclature

■ Type number nomenclature

● UL489 Listed

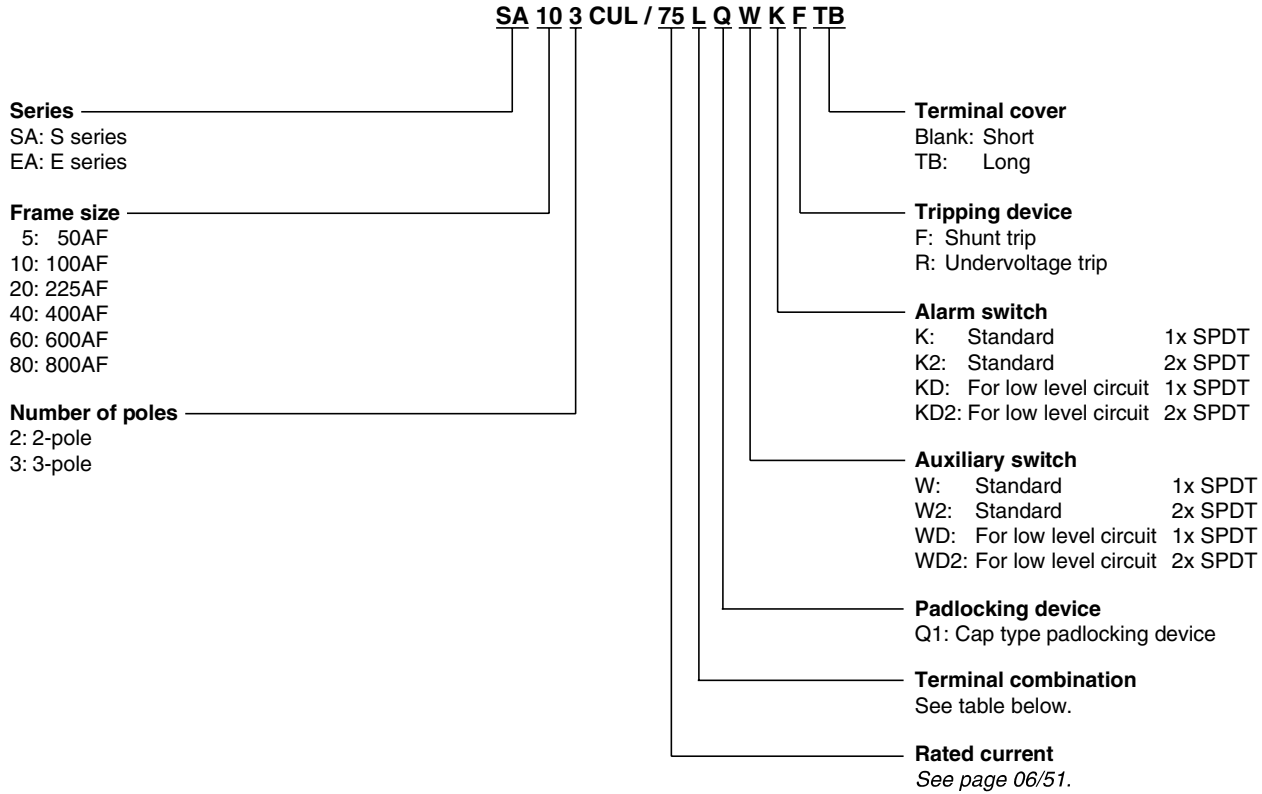

■ Terminal combination

Code	Terminal position		Applicable breaker type				
	Line	Load	SA50RCUL EA100CUL	SA100CUL SA100RCUL SA225CUL SA225RCUL	SA400CUL SA400RCUL	SA600RCUL SA800RCUL/700	SA800RCUL/800
Blank	Screw	Screw	●	●	—	—	—
L	Block terminal	Block terminal	—	●	●	●	●
L1	Flat terminal	Flat terminal	●	●	●	●	—
L3	Screw	Flat terminal	●	●	—	—	—
L4	Flat terminal	Screw	●	●	—	—	—
L5	Screw	Block terminal	—	●	—	—	—
L6	Block terminal	Screw	—	●	—	—	—
L7	Flat terminal	Block terminal	—	●	●	●	—
L8	Block terminal	Flat terminal	—	●	●	●	—

● Available — Not available

Molded Case Circuit Breakers

Type number

Line protection

● S series, 4-pole

Breaker ampere frame	Rated current (A)	Type	□ : Available mounting and connection
50	5	SA54B/5□	Blank, X, E, Y
	10	SA54B/10□	Blank, X, E, Y
	15	SA54B/15□	Blank, X, E, Y
	20	SA54B/20□	Blank, X, E, Y
	30	SA54B/30□	Blank, X, E, Y
	40	SA54B/40□	Blank, X, E, Y
100	50	SA54B/50□	Blank, X, E, Y
	15	SA104R/15□	Blank, X, E
	20	SA104R/20□	Blank, X, E
	30	SA104R/30□	Blank, X, E
	40	SA104R/40□	Blank, X, E
	50	SA104R/50□	Blank, X, E
225	60	SA104R/60□	Blank, X, E
	75	SA104R/75□	Blank, X, E
	100	SA104R/100□	Blank, X, E
	125	SA204R/125□	Blank, X, E
	150	SA204R/150□	Blank, X, E
	175	SA204R/175□	Blank, X, E
400	200	SA204R/200□	Blank, X, E
	225	SA204R/225□	Blank, X, E
	250	SA404HA/250□	Blank, X, E
	300	SA404HA/300□	Blank, X, E
600	350	SA404HA/350□	Blank, X, E
	400	SA404HA/400□	Blank, X, E
	500	SA604H/500□	Blank, X, E
800	600	SA604H/600□	Blank, X, E
	700	SA804H/700□	Blank, X, E
1000	800	SA804H/800□	Blank, X, E
	500 to 1000	SA1004/1000E□	Blank, X, E
1200	600 to 1200	SA1204/1200E□	Blank, X, E
1600	800 to 1600	SA1604E/1600□	Blank, X, E

● E series, 2-pole IEC and CE marking conformed

Breaker ampere frame	Rated current (A)	Type	□ : Available mounting and connection	
30	3	EA32AC/3□-CE	Blank, X, E, Y, P	
	5	EA32AC/5□-CE		
	10	EA32AC/10□-CE		
	15	EA32AC/15□-CE		
	20	EA32AC/20□-CE		
	30	EA32AC/30□-CE		
50	5	EA52AC/5□-CE	Blank, X, E, Y, P	
	10	EA52AC/10□-CE		
	15	EA52AC/15□-CE		
	20	EA52AC/20□-CE		
	30	EA52AC/30□-CE		
	60	40	EA52AC/40□-CE	Blank, X, E, Y, P
		50	EA52AC/50□-CE	
		60	EA62C/60□-CE	
		50	EA102C/50□-CE	
		60	EA102C/60□-CE	
100	75	EA102C/75□-CE	Blank, X, E, Y, P	
	100	EA102C/100□-CE		
	125	EA202C/125□-CE		
	150	EA202C/150□-CE		
225	175	EA202C/175□-CE	Blank, X, E, P	
	200	EA202C/200□-CE		
	225	EA202C/225□-CE		
	250	EA402C/250□-CE		
	300	EA402C/300□-CE		
400	350	EA402C/350□-CE	Blank, X, E, P	
	400	EA402C/400□-CE		

● E series, 3-pole IEC and CE marking conformed

Breaker ampere frame	Rated current (A)	Type	□ : Available mounting and connection	
30	3	EA33AC/3□-CE	Blank, X, E, Y, P	
	5	EA33AC/5□-CE		
	10	EA33AC/10□-CE		
	15	EA33AC/15□-CE		
	20	EA33AC/20□-CE		
	30	EA33AC/30□-CE		
50	5	EA53AC/5□-CE	Blank, X, E, Y, P	
	10	EA53AC/10□-CE		
	15	EA53AC/15□-CE		
	20	EA53AC/20□-CE		
	30	EA53AC/30□-CE		
	40	EA53AC/40□-CE		
	50	EA53AC/50□-CE		
	50	5	EA53C/5□-CE	Blank, X, E, Y, P
		10	EA53C/10□-CE	
		15	EA53C/15□-CE	
		20	EA53C/20□-CE	
		30	EA53C/30□-CE	
40		EA53C/40□-CE		
50	EA53C/50□-CE			
60	60	EA63C/60□-CE	Blank, X, E, Y, P	
100	60	EA103AC/60-CE	Blank, X, E, Y, P	
	75	EA103AC/75-CE		
100	100	EA103AC/100-CE	Blank, X, E, Y, P	
	50	EA103C/50□-CE		
	60	EA103C/60□-CE		
	75	EA103C/75□-CE		
225	100	EA103C/100□-CE	Blank, X, E, P	
	125	EA203C/125□-CE		
	150	EA203C/150□-CE		
	175	EA203C/175□-CE		
	200	EA203C/200□-CE		
400	225	EA203C/225□-CE	Blank, X, E, P	
	250	EA403C/250□-CE		
	300	EA403C/300□-CE		
	350	EA403C/350□-CE		
600	400	EA403C/400□-CE	Blank, X, E, P, D	
	500	EA603C/500□-CE		
800	600	EA603C/600□-CE	Blank, X, E, P, D	
	700	EA803C/700□-CE		
800	800	EA803C/800□-CE	Blank, X, E, P, D	

● E series, 4-pole

Breaker ampere frame	Rated current (A)	Type	□ : Available mounting and connection
100	50	EA104B/50□	Blank, X, E, Y
	60	EA104B/60□	
	75	EA104B/75□	
	100	EA104B/100□	

Molded Case Circuit Breakers

Dimensions

S series/3, 4-pole

■ Dimensions, mm

● Front mounting, front connection

SA1603E, SA1604E

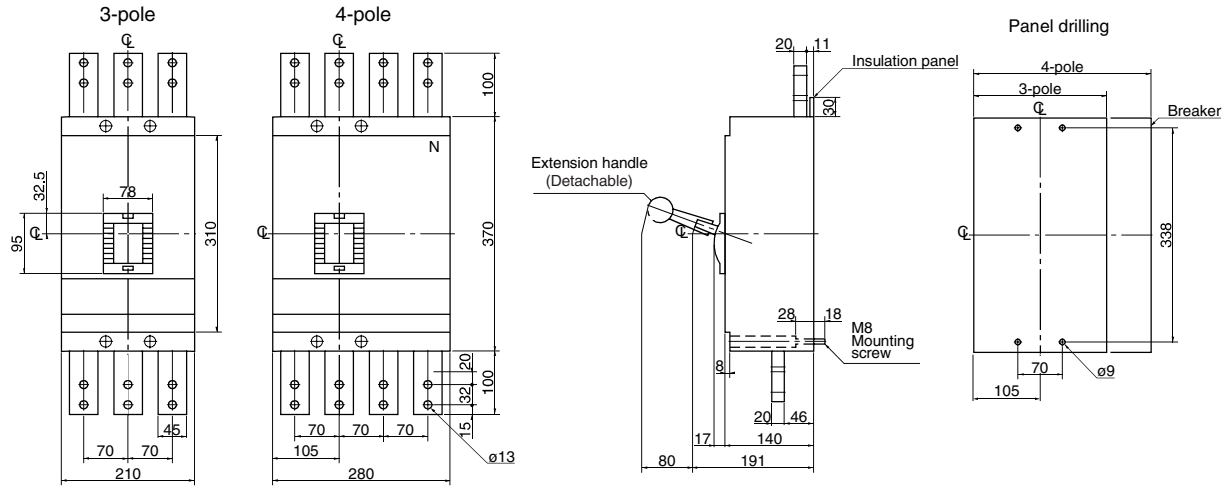

SA54B

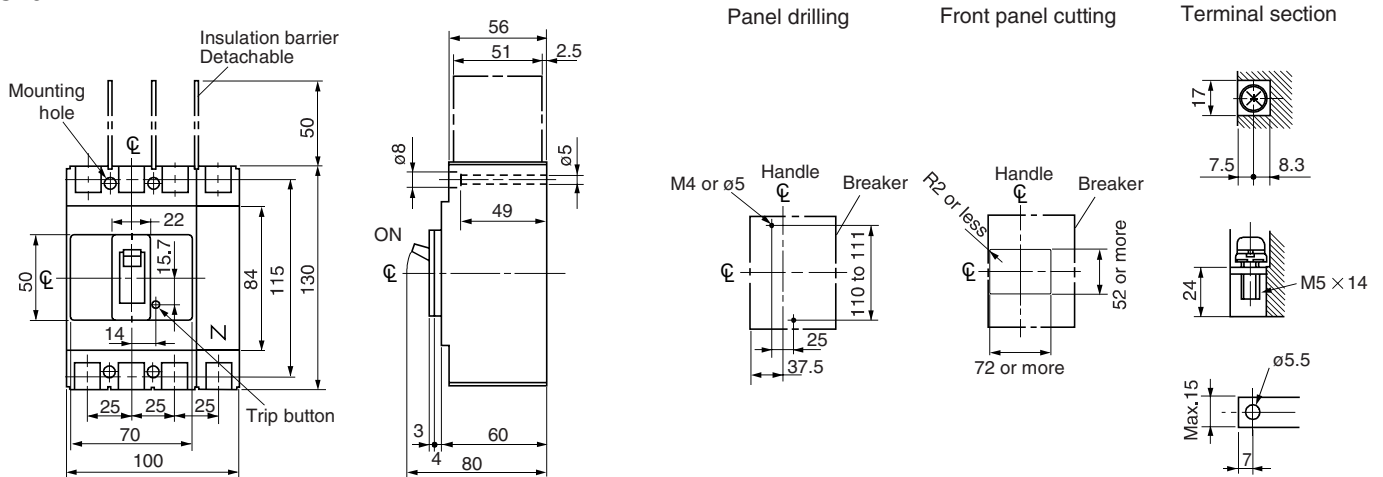

SA104R

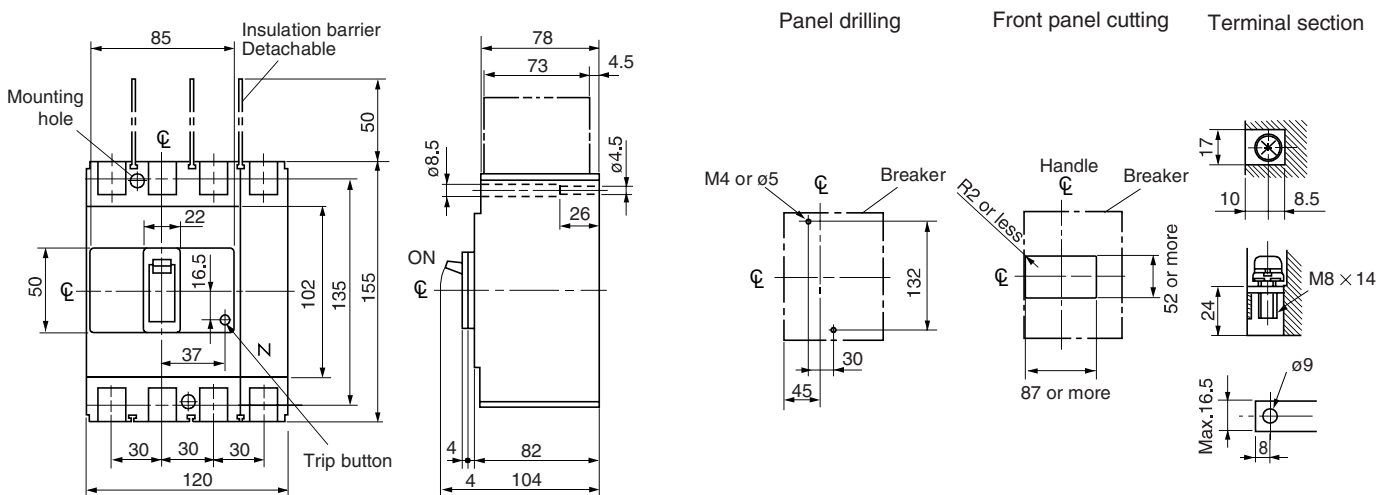

Molded Case Circuit Breakers

Dimensions

S series/4-pole

■ Dimensions, mm

● Front mounting, front connection

SA204R

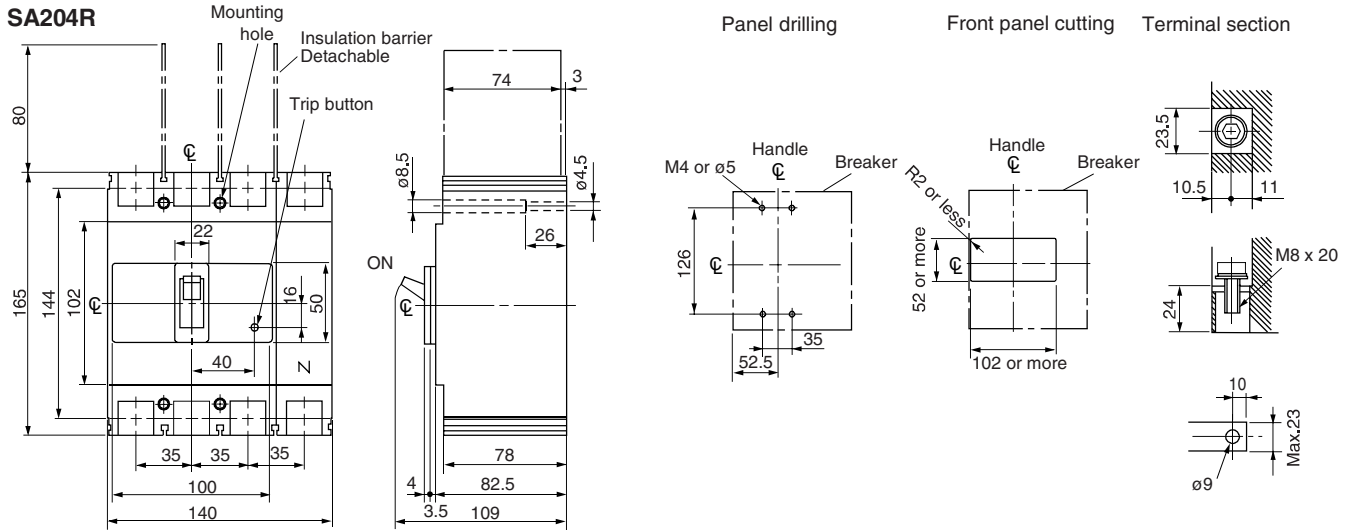

SA404HA

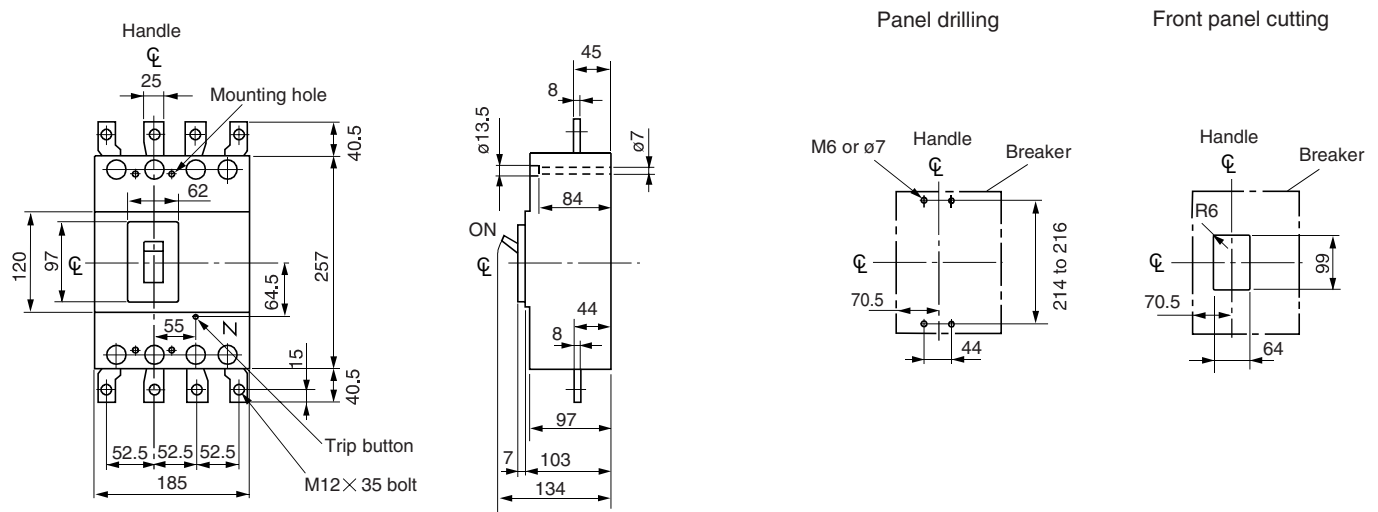

SA604H, 804H

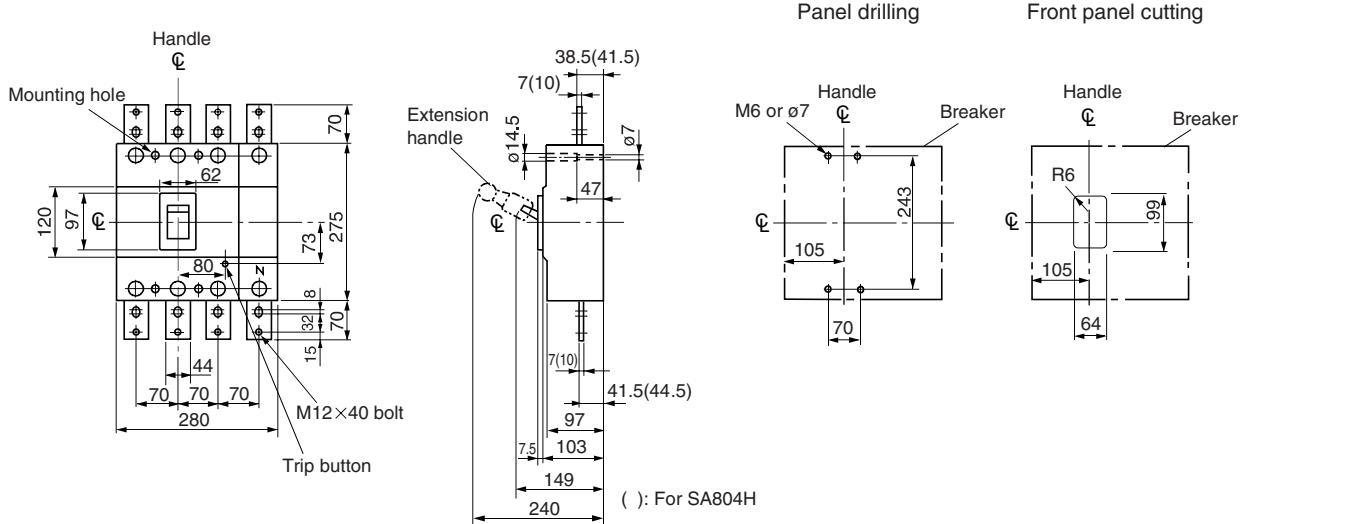

Molded Case Circuit Breakers

Dimensions

E series/2, 3, 4-pole

■ Dimensions, mm

● Front mounting, front connection

EA803C □ -CE

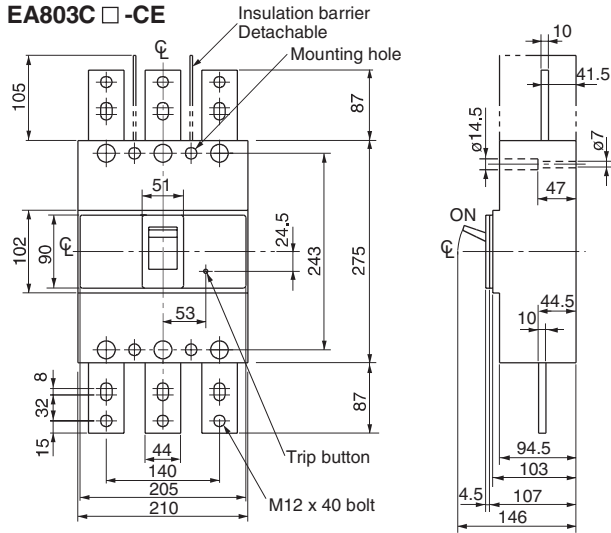

Panel drilling

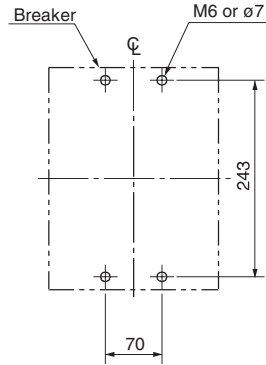

Front panel cutting

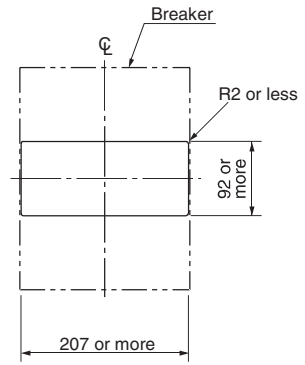

EA104B

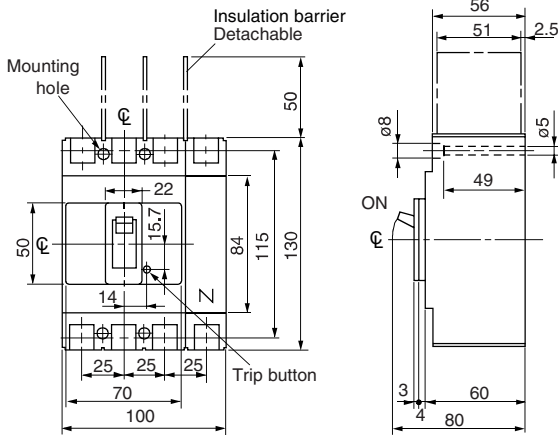

Panel drilling

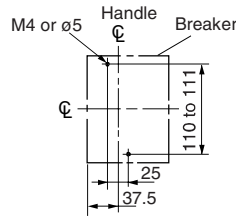

Front panel cutting

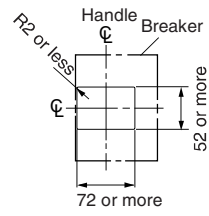

Terminal section

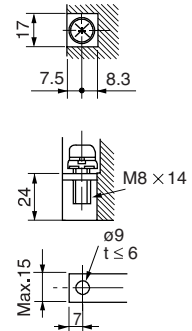

● Front mounting, rear connection (type X)

EA32AC □ -CE, 52AC □ -CE, 52C □ -CE

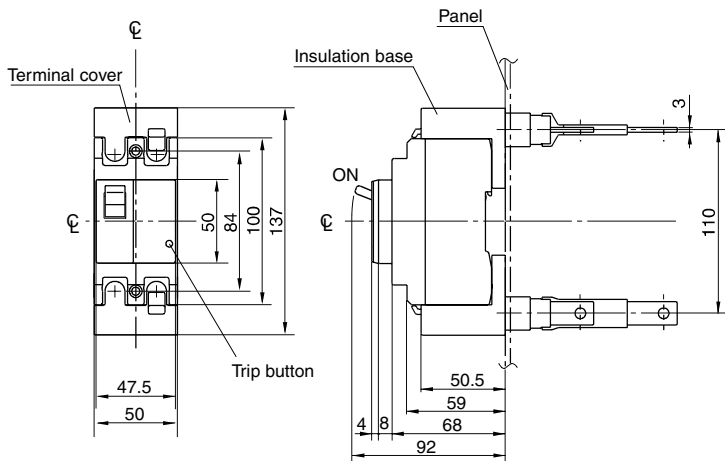

Panel drilling

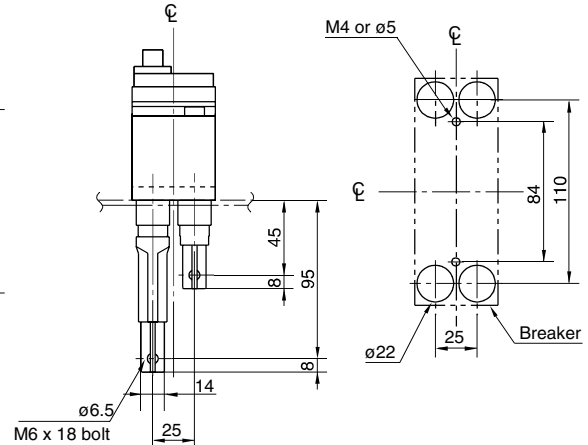

Molded Case Circuit Breakers Characteristic curves Line protection

■ S and E series, 4-pole

SA54B

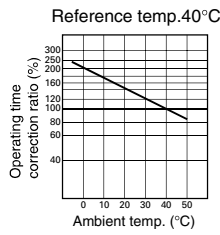
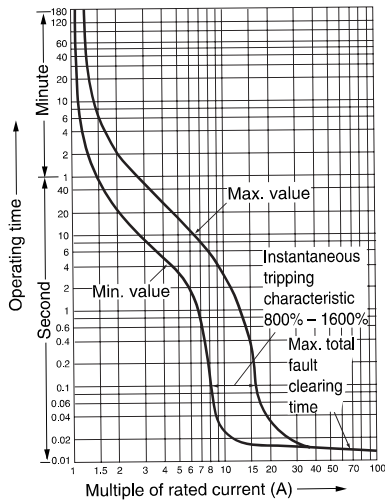

SA204R

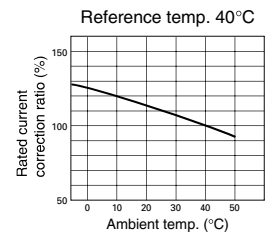
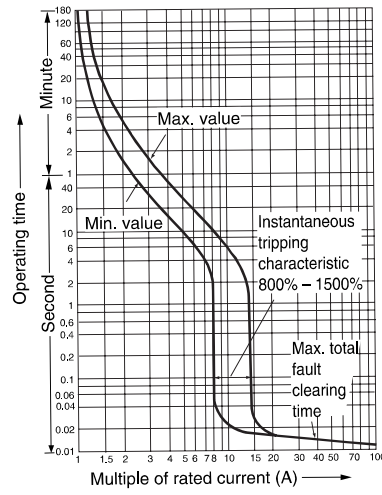

EA104B

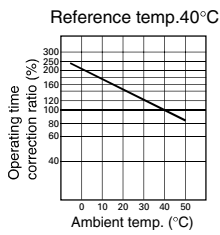
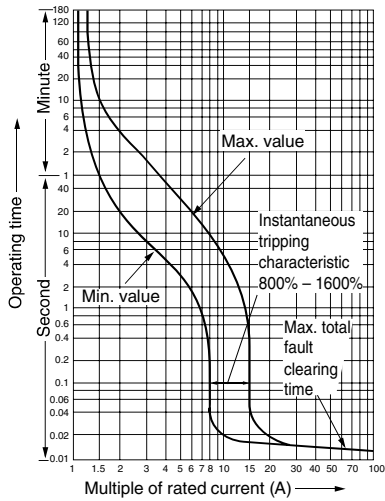

SA404HA

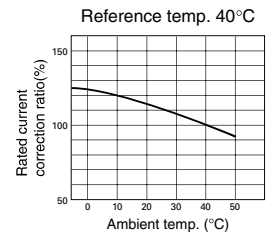
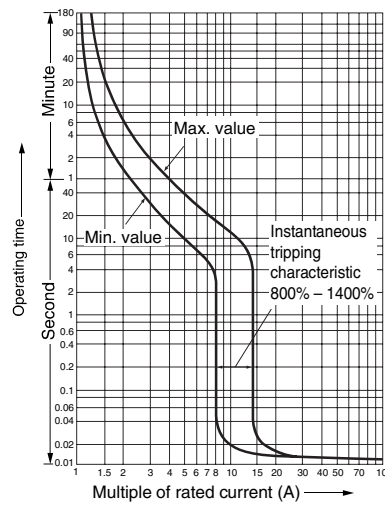

SA104R

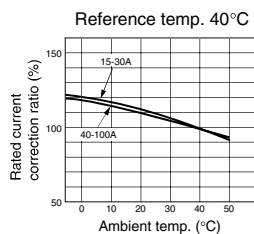
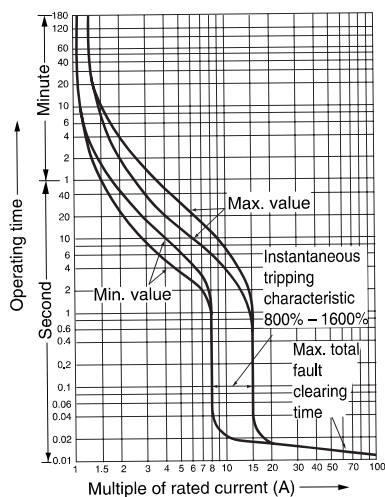

SA604H

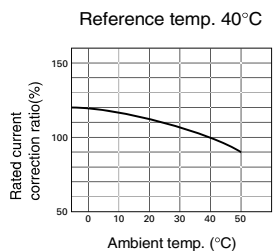
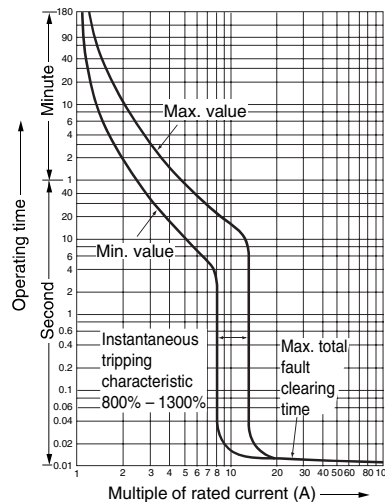

Molded Case Circuit Breakers

Characteristic curves

Line protection

■ S series, 4-pole

SA804H

