

**75A, 1200V Hyperfast Diode**

The RHRG75120 is a hyperfast diode with soft recovery characteristics ( $t_{rr} < 85\text{ns}$ ). It has half the recovery time of ultrafast diodes and is silicon nitride passivated ion-implanted epitaxial planar construction.

This device is intended for use as a freewheeling/clamping diode and rectifier in a variety of high frequency switching power supplies and other power switching applications. Its low stored charge and hyperfast soft recovery characteristic minimize ringing and electrical noise in many power switching circuits, thus reducing power loss in the switching transistors.

Formerly developmental type TA49042.

**Ordering Information**

PART NUMBER	PACKAGE	BRAND
RHRG75120	TO-247	RHRG75120

NOTE: When ordering, use the entire part number.

**Symbol**



**Features**

- Hyperfast with Soft Recovery . . . . . <85ns
- Operating Temperature . . . . . 175°C
- Reverse Voltage . . . . . 1200V
- Avalanche Energy Rated
- Planar Construction

**Applications**

- Switching Power Supplies
- Power Switching Circuits
- General Purpose

**Packaging**

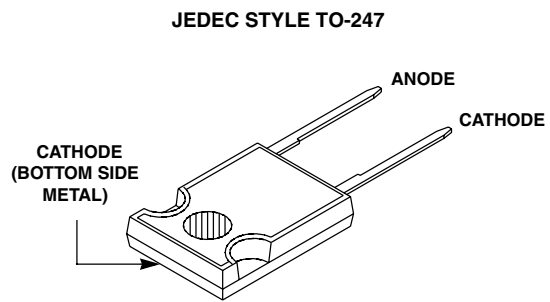

**Absolute Maximum Ratings**  $T_C = 25^\circ\text{C}$

	RHRG75120	UNITS
Peak Repetitive Reverse Voltage . . . . . $V_{RRM}$	1200	V
Working Peak Reverse Voltage . . . . . $V_{RWM}$	1200	V
DC Blocking Voltage . . . . . $V_R$	1200	V
Average Rectified Forward Current . . . . . $I_{F(AV)}$ ( $T_C = 42^\circ\text{C}$ )	75	A
Repetitive Peak Surge Current . . . . . $I_{FRM}$ (Square Wave, 20kHz)	150	A
Nonrepetitive Peak Surge Current . . . . . $I_{FSM}$ (Halfwave, 1 Phase, 60Hz)	500	A
Maximum Power Dissipation . . . . . $P_D$	190	W
Avalanche Energy (See Figures 7 and 8) . . . . . $E_{AVL}$	50	mJ
Operating and Storage Temperature . . . . . $T_{STG}, T_J$	-65 to 175	°C

# RHRG75120

## Electrical Specifications $T_C = 25^\circ\text{C}$ , Unless Otherwise Specified

SYMBOL	TEST CONDITION	MIN	TYP	MAX	UNITS
$V_F$	$I_F = 75\text{A}$	-	-	3.2	V
	$I_F = 75\text{A}, T_C = 150^\circ\text{C}$	-	-	2.6	V
$I_R$	$V_R = 1200\text{V}$	-	-	250	$\mu\text{A}$
	$V_R = 1200\text{V}, T_C = 150^\circ\text{C}$	-	-	2	mA
$t_{rr}$	$I_F = 1\text{A}, dI_F/dt = 100\text{A}/\mu\text{s}$	-	-	85	ns
	$I_F = 75\text{A}, dI_F/dt = 100\text{A}/\mu\text{s}$	-	-	100	ns
$t_a$	$I_F = 75\text{A}, dI_F/dt = 100\text{A}/\mu\text{s}$	-	60	-	ns
$t_b$	$I_F = 75\text{A}, dI_F/dt = 100\text{A}/\mu\text{s}$	-	25	-	ns
$R_{\theta JC}$		-	-	0.8	$^\circ\text{C}/\text{W}$

### DEFINITIONS

$V_F$  = Instantaneous forward voltage ( $p_w = 300\mu\text{s}$ ,  $D = 2\%$ ).

$I_R$  = Instantaneous reverse current.

$t_{rr}$  = Reverse recovery time (See Figure 6), summation of  $t_a + t_b$ .

$t_a$  = Time to reach peak reverse current (See Figure 6).

$t_b$  = Time from peak  $I_{RM}$  to projected zero crossing of  $I_{RM}$  based on a straight line from peak  $I_{RM}$  through 25% of  $I_{RM}$  (See Figure 6).

$R_{\theta JC}$  = Thermal resistance junction to case.

$p_w$  = Pulse width.

$D$  = Duty cycle.

## Typical Performance Curves

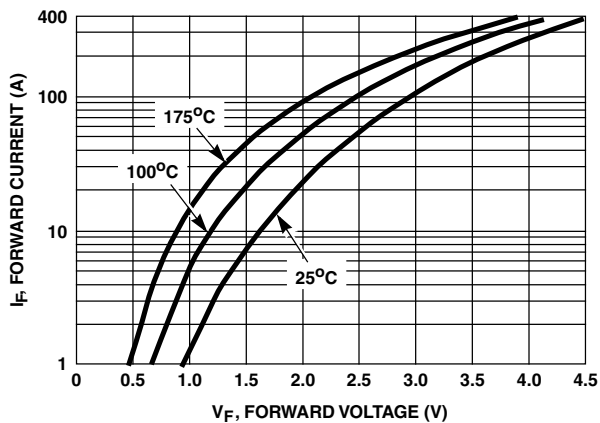

FIGURE 1. FORWARD CURRENT vs FORWARD VOLTAGE

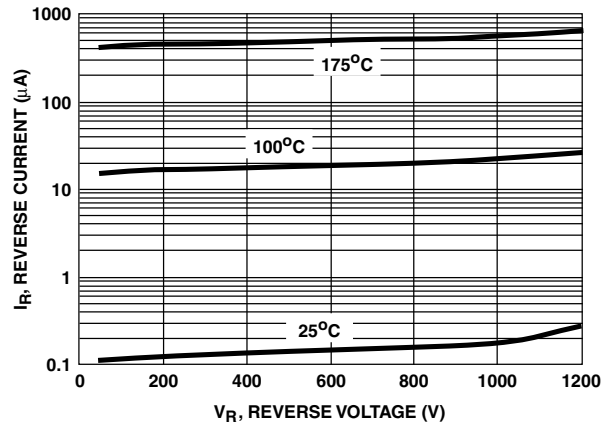

FIGURE 2. REVERSE CURRENT vs REVERSE VOLTAGE

Typical Performance Curves (Continued)

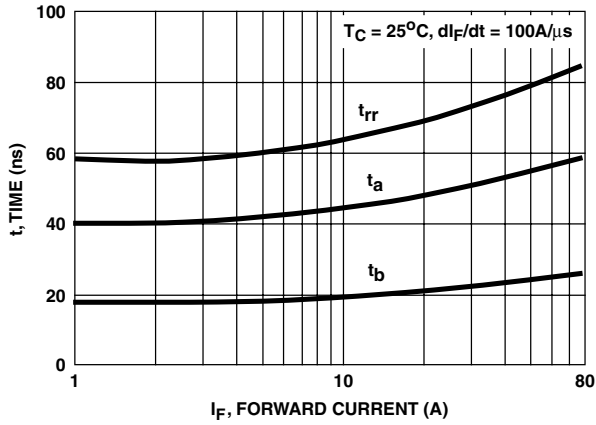

FIGURE 3.  $t_{rr}$ ,  $t_a$  AND  $t_b$  CURVES vs FORWARD CURRENT

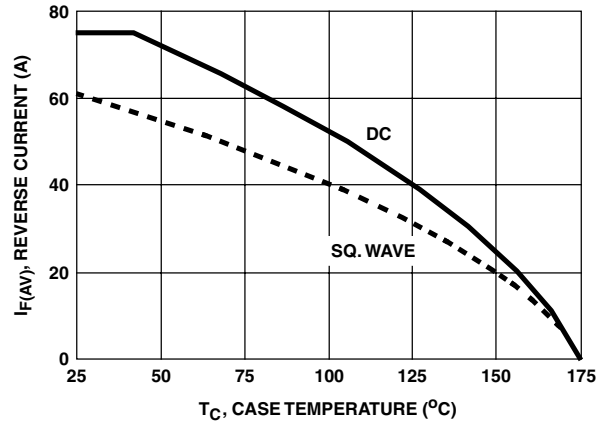

FIGURE 4. CURRENT DERATING CURVE

Test Circuits and Waveforms

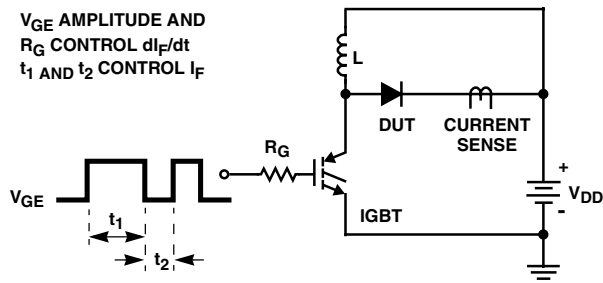

FIGURE 5.  $t_{rr}$  TEST CIRCUIT

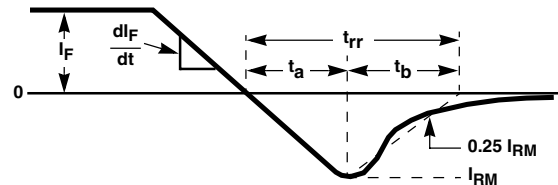

FIGURE 6.  $t_{rr}$  WAVEFORMS AND DEFINITIONS

$I_{MAX} = 1.6A$   
 $L = 40mH$   
 $R < 0.1\Omega$   
 $E_{AVL} = 1/2LI^2 [V_{R(AVL)}/(V_{R(AVL)} - V_{DD})]$   
 $Q_1 = IGBT (BV_{CES} > DUT V_{R(AVL)})$

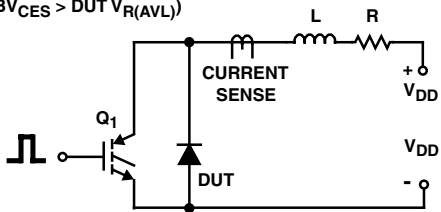

FIGURE 7. AVALANCHE ENERGY TEST CIRCUIT

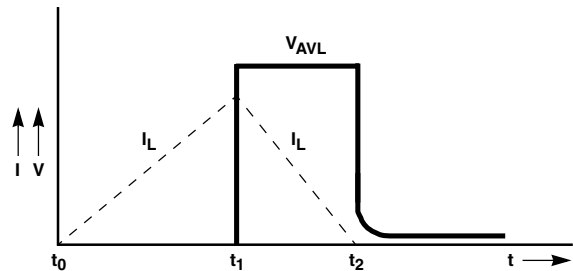

FIGURE 8. AVALANCHE CURRENT AND VOLTAGE WAVEFORMS

## TRADEMARKS

The following are registered and unregistered trademarks Fairchild Semiconductor owns or is authorized to use and is not intended to be an exhaustive list of all such trademarks.

ACE <sub>x</sub> <sup>TM</sup>	FAST <sup>®</sup>	PACMAN <sup>TM</sup>	SuperSOT <sup>TM</sup> -3
Bottomless <sup>TM</sup>	FAST <sub>r</sub> <sup>TM</sup>	POP <sup>TM</sup>	SuperSOT <sup>TM</sup> -6
CoolFET <sup>TM</sup>	GlobalOptoisolator <sup>TM</sup>	PowerTrench <sup>®</sup>	SuperSOT <sup>TM</sup> -8
CROSSVOLT <sup>TM</sup>	GTO <sup>TM</sup>	QFET <sup>TM</sup>	SyncFET <sup>TM</sup>
DenseTrench <sup>TM</sup>	HiSeC <sup>TM</sup>	QS <sup>TM</sup>	TinyLogic <sup>TM</sup>
DOMET <sup>TM</sup>	ISOPLANAR <sup>TM</sup>	QT Optoelectronics <sup>TM</sup>	UHC <sup>TM</sup>
EcoSPARK <sup>TM</sup>	LittleFET <sup>TM</sup>	Quiet Series <sup>TM</sup>	UltraFET <sup>TM</sup>
E <sup>2</sup> CMOS <sup>TM</sup>	MicroFET <sup>TM</sup>	SILENT SWITCHER <sup>®</sup>	VCX <sup>TM</sup>
EnSigna <sup>TM</sup>	MICROWIRE <sup>TM</sup>	SMART START <sup>TM</sup>	
FACT <sup>TM</sup>	OPTOLOGIC <sup>TM</sup>	Star* Power <sup>TM</sup>	
FACT Quiet Series <sup>TM</sup>	OPTOPLANAR <sup>TM</sup>	Stealth <sup>TM</sup>	

## DISCLAIMER

FAIRCHILD SEMICONDUCTOR RESERVES THE RIGHT TO MAKE CHANGES WITHOUT FURTHER NOTICE TO ANY PRODUCTS HEREIN TO IMPROVE RELIABILITY, FUNCTION OR DESIGN. FAIRCHILD DOES NOT ASSUME ANY LIABILITY ARISING OUT OF THE APPLICATION OR USE OF ANY PRODUCT OR CIRCUIT DESCRIBED HEREIN; NEITHER DOES IT CONVEY ANY LICENSE UNDER ITS PATENT RIGHTS, NOR THE RIGHTS OF OTHERS.

## LIFE SUPPORT POLICY

FAIRCHILD'S PRODUCTS ARE NOT AUTHORIZED FOR USE AS CRITICAL COMPONENTS IN LIFE SUPPORT DEVICES OR SYSTEMS WITHOUT THE EXPRESS WRITTEN APPROVAL OF FAIRCHILD SEMICONDUCTOR CORPORATION. As used herein:

1. Life support devices or systems are devices or systems which, (a) are intended for surgical implant into the body, or (b) support or sustain life, or (c) whose failure to perform when properly used in accordance with instructions for use provided in the labeling, can be reasonably expected to result in significant injury to the user.
2. A critical component is any component of a life support device or system whose failure to perform can be reasonably expected to cause the failure of the life support device or system, or to affect its safety or effectiveness.

## PRODUCT STATUS DEFINITIONS

### Definition of Terms

Datasheet Identification	Product Status	Definition
Advance Information	Formative or In Design	This datasheet contains the design specifications for product development. Specifications may change in any manner without notice.
Preliminary	First Production	This datasheet contains preliminary data, and supplementary data will be published at a later date. Fairchild Semiconductor reserves the right to make changes at any time without notice in order to improve design.
No Identification Needed	Full Production	This datasheet contains final specifications. Fairchild Semiconductor reserves the right to make changes at any time without notice in order to improve design.
Obsolete	Not In Production	This datasheet contains specifications on a product that has been discontinued by Fairchild semiconductor. The datasheet is printed for reference information only.