

DIODE MODULE 75A/800V

PT76S8

FEATURES

- * Isolated Base
- * 3 Phase Bridge Circuit
- * Designed Power Circuit Board
- * High Surge Capability
- * UL Recognized, File No. E187184

TYPICAL APPLICATIONS

- * Rectified For General Use

OUTLINE DRAWING

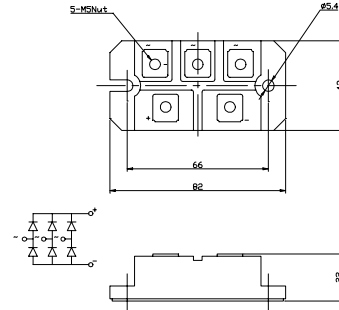

Maximum Ratings

Approx Net Weight:180g

Parameter	Symbol	Type / Grade	Unit
		PT76S8	
Repetitive Peak Reverse Voltage *1	V_{RRM}	800	V
Non Repetitive Peak Reverse Voltage *1	V_{RSM}	1000	

Parameter		Conditions	Max Rated Value	Unit	
Average Rectified Output Current	$I_{O(AV)}$	3-Phase Full Wave Rectified $T_c = T_t(\text{Terminal}) = 112^\circ\text{C}$	75	A	
Surge Forward Current *1	I_{FSM}	50 Hz Half Sine Wave, 1Pulse Non-repetitive	1000	A	
I Squared t *1	I^2t	2msec to 10msec	5000	A ² s	
Operating Junction Temperature Range	T_{jw}		-40 to +150	°C	
Storage Temperature Range	T_{stg}		-40 to +125	°C	
Isolation Voltage	Viso	Base Plate to Terminals, AC1min	2000	V	
Mounting torque	Case mounting	Ftor	Greased	2.4 to 2.8	N.m
	Terminals		M5		

Electrical • Thermal Characteristics

Characteristics	Symbol	Test Conditions	Max.	Unit
Peak Reverse Current *1	I_{RM}	$V_{RM} = V_{RRM}, T_j = 150^\circ\text{C}$	10	mA
Peak Forward Voltage *1	V_{FM}	$I_{FM} = 75\text{A}, T_j = 25^\circ\text{C}$	1.2	V
Thermal Resistance	$R_{th(j-c)}$	Junction to Case (Total)	0.24	°C/W
	$R_{th(c-f)}$	Base Plate to Heat Sink with Thermal Compound (Total)	0.06	

*1: Value Per 1Arm

PT76S8 OUTLINE DRAWING (Dimensions in mm)

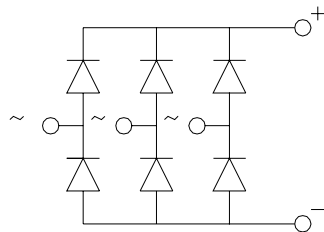
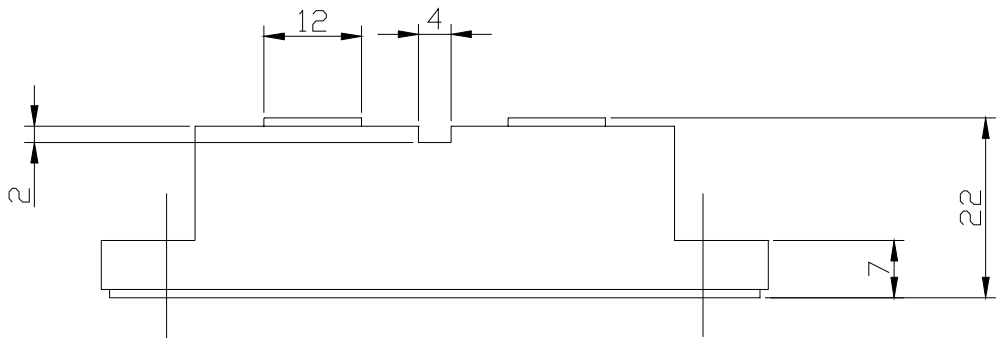
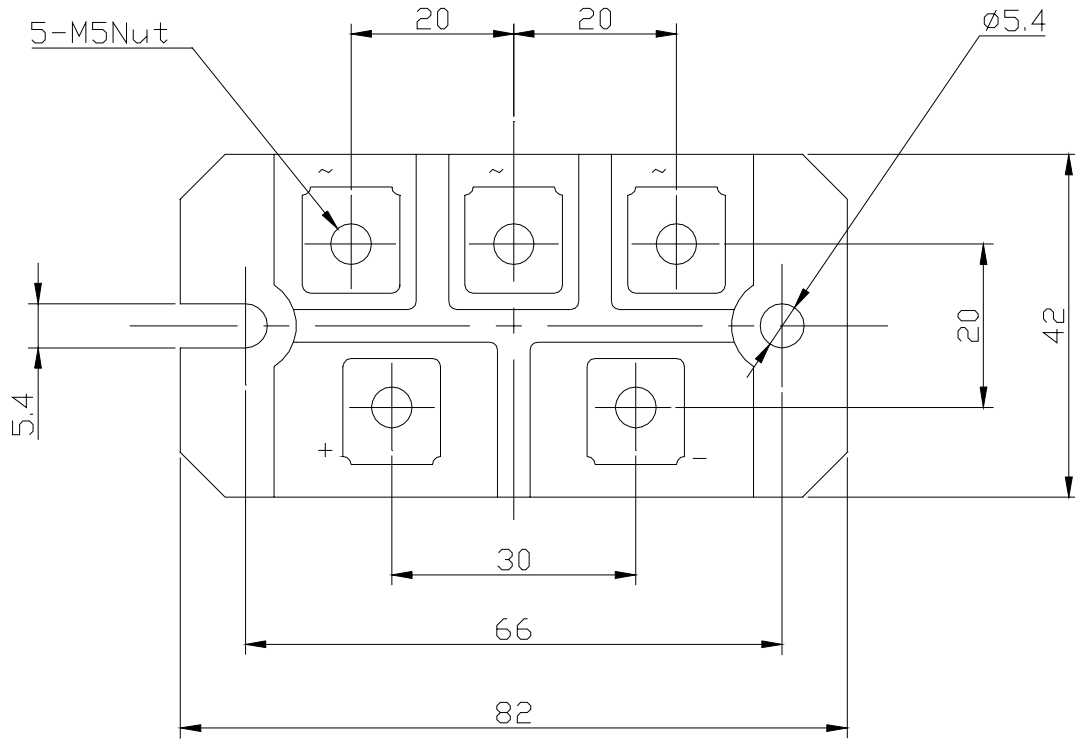

順電圧特性
FORWARD CURRENT VS. VOLTAGE

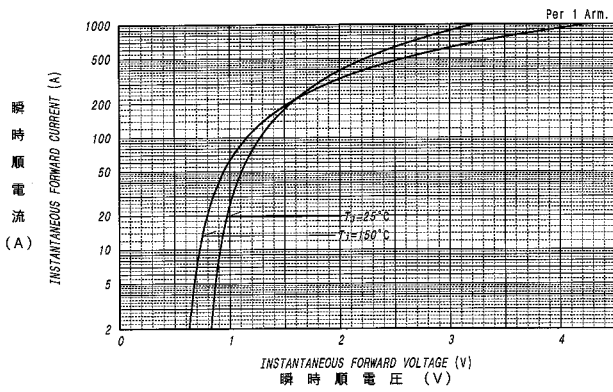

平均順電力損失特性
AVERAGE FORWARD POWER DISSIPATION

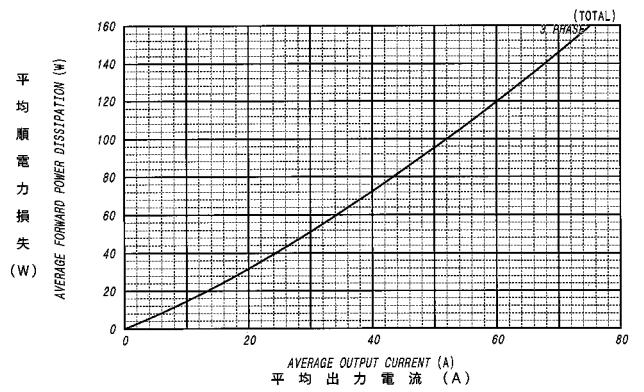

平均出力電流 - ケース温度定格
AVERAGE OUTPUT CURRENT VS. CASE TEMPERATURE

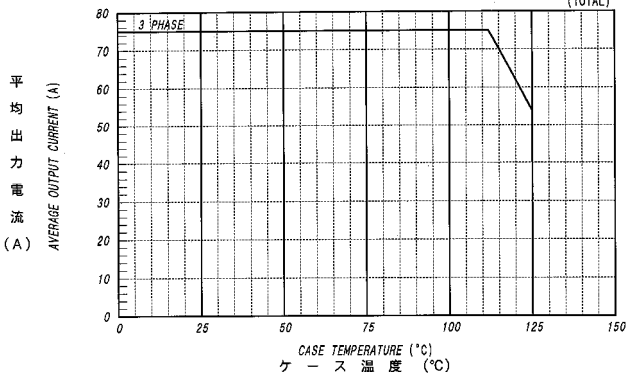

サージ順電流定格
SURGE CURRENT RATINGS

