

# DIODE MODULE 75A/1200V/1600V PT76S12 PT76S16

## FEATURES

- \* Isolated Base
- \* 3 Phase Bridge Circuit
- \* Designed Power Circuit Board
- \* High Surge Capability
- \* UL Recognized, File No. E187184

## TYPICAL APPLICATIONS

- \* Rectified For General Use

## OUTLINE DRAWING

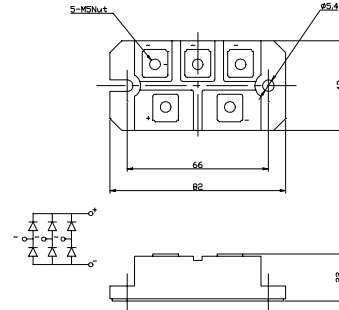

## Maximum Ratings

Approx Net Weight:180g

Parameter	Symbol	Type / Grade		Unit
		P76S12	PT76S16	
Repetitive Peak Reverse Voltage *1	$V_{RRM}$	1200	1600	V
Non Repetitive Peak Reverse Voltage *1	$V_{RSM}$	1300	1750	

Parameter		Conditions	Max Rated Value	Unit	
Average Rectified Output Current	$I_{O(AV)}$	3-Phase Full Wave Rectified $T_c = T_t(\text{Terminal}) = 75^\circ\text{C}$	75	A	
Surge Forward Current *1	$I_{FSM}$	50 Hz Half Sine Wave, 1Pulse Non-repetitive	540	A	
I Squared t *1	$I^2t$	2msec to 10msec	1500	A <sup>2</sup> s	
Operating Junction Temperature Range	$T_{jw}$		-40 to +125	°C	
Storage Temperature Range	$T_{stg}$		-40 to +125	°C	
Isolation Voltage	Viso	Base Plate to Terminals, AC1min	2500	V	
Mounting torque	Case mounting	Ftor	Greased	2.4 to 2.8	N.m
	Terminals		M5		

## Electrical • Thermal Characteristics

Characteristics	Symbol	Test Conditions	Max.	Unit
Peak Reverse Current *1	$I_{RM}$	$V_{RM} = V_{RRM}, T_j = 125^\circ\text{C}$	10	mA
Peak Forward Voltage *1	$V_{FM}$	$I_{FM} = 75\text{A}, T_j = 25^\circ\text{C}$	1.4	V
Thermal Resistance	$R_{th(j-c)}$	Junction to Case (Total)	0.24	°C/W
	$R_{th(c-f)}$	Base Plate to Heat Sink with Thermal Compound (Total)	0.06	

\*1: Value Per 1Arm

PT76S1x OUTLINE DRAWING (Dimensions in mm)

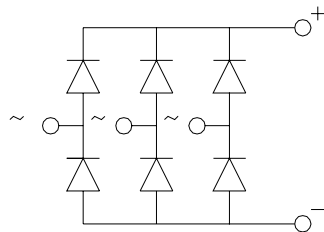
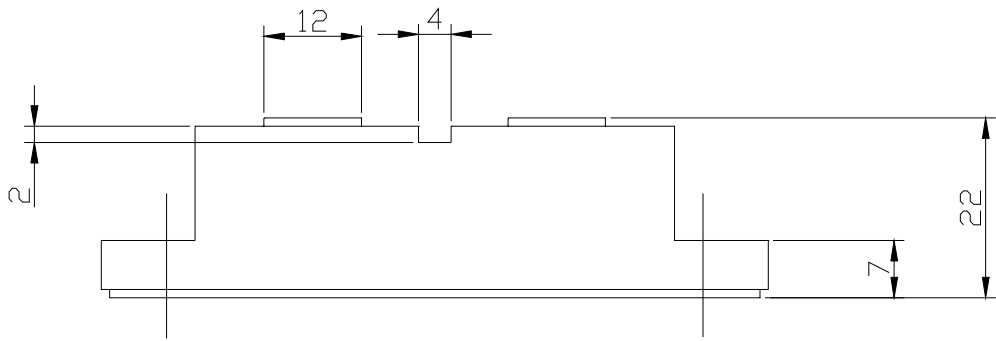
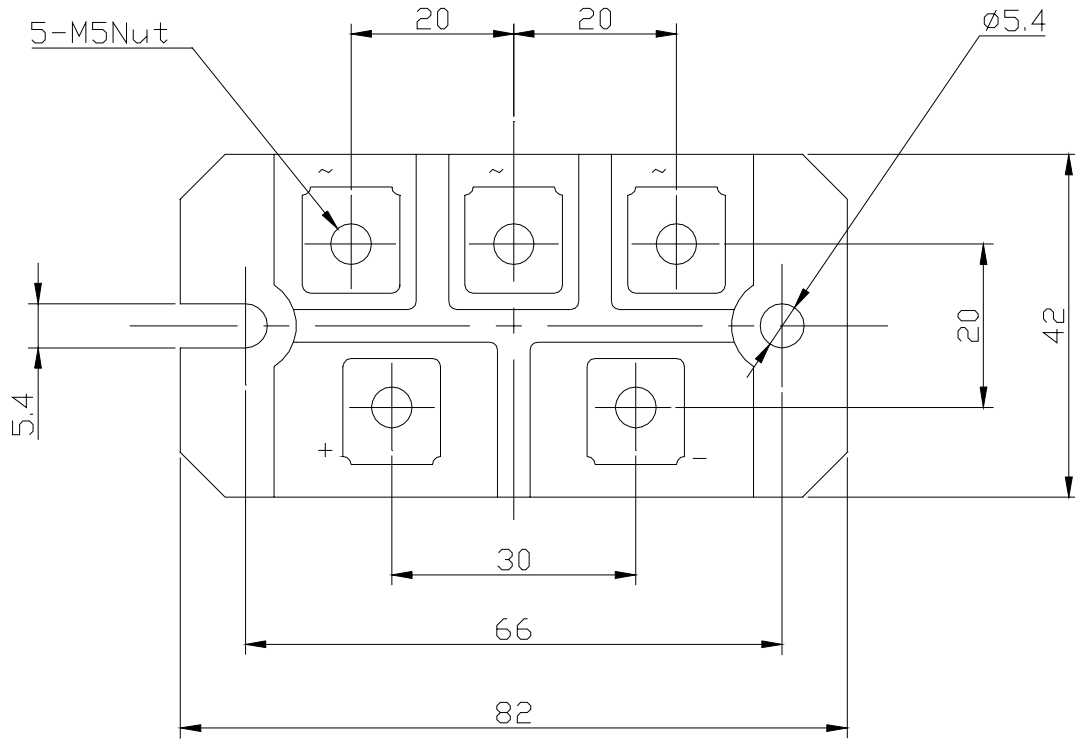

順電圧特性  
FORWARD CURRENT VS. VOLTAGE

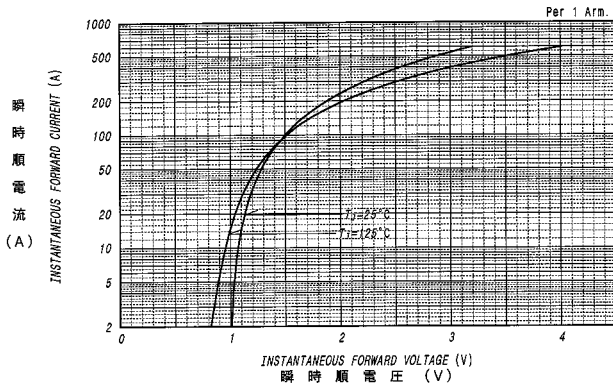

平均順電力損失特性  
AVERAGE FORWARD POWER DISSIPATION

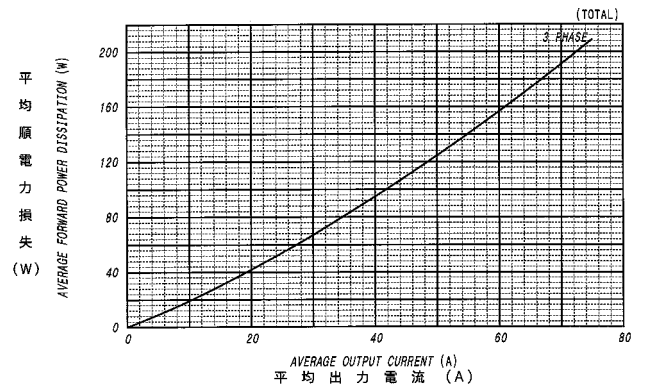

平均出力電流 - ケース温度定格  
AVERAGE OUTPUT CURRENT VS. CASE TEMPERATURE

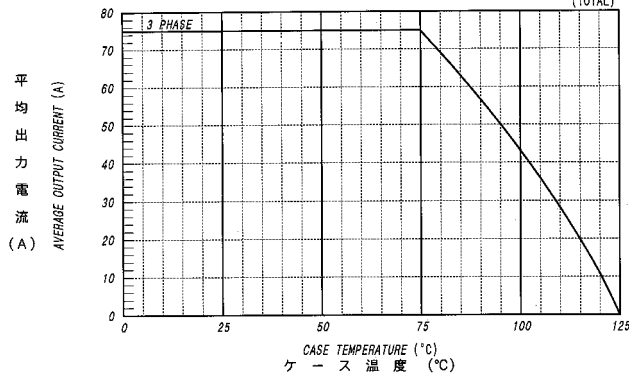

サージ順電流定格  
SURGE CURRENT RATINGS

