

# PS12012-A

FLAT-BASE TYPE  
INSULATED TYPE

## PS12012-A



### INTEGRATED FUNCTIONS AND FEATURES

- 3-Phase IGBT inverter bridge configured by the latest 3rd. generation IGBT and diode technologies.
- Circuit for dynamic braking of motor regenerative energy.
- Inverter output current capability  $I_o$  (Note 1) :

Type Name	100% load	150% over load
PS12012-A	1.2A (rms)	1.8A (rms), 1min

(Note 1) : The inverter output current is assumed to be sinusoidal and the peak current value of each of the above loading cases is defined as :  $I_{op} = I_o \times \sqrt{2}$

### INTEGRATED DRIVE, PROTECTION AND SYSTEM CONTROL FUNCTIONS:

- For P-Side IGBTs : Drive circuit, High-speed photo-couplers, Short circuit protection (SC), Bootstrap circuit supply scheme (Single drive power supply ) and Under-voltage protection (UV).
- For N-Side IGBTs : Drive circuit, Short-circuit protection (SC), Control supply Under voltage and Over voltage protection (OV/UV), System Over temperature protection (OT), Fault output signaling circuit (Fo), and Current-Limit warning signal output (CL).
- For Brake circuit IGBT : Drive circuit.
- Warning and Fault signaling :
  - FO1 : Short circuit protection for lower-leg IGBTs and Input interlocking against spurious arm shoot-through.
  - FO2 : N-side control supply abnormality locking (OV/UV)
  - FO3 : System over-temperature protection (OT).
  - CL : Warning for inverter current overload condition
- For system feedback control : Analogue signal feedback reproducing actual inverter output phase current ( $3\phi$ ).
- Input Interface : 5V CMOS/TTL compatible, Schmitt trigger input, and Arm-Shoot-Through interlock protection.

## APPLICATION

Acoustic noise-less 0.2kW/AC400V Class 3 Phase inverter and other motor control applications.

### PACKAGE OUTLINES

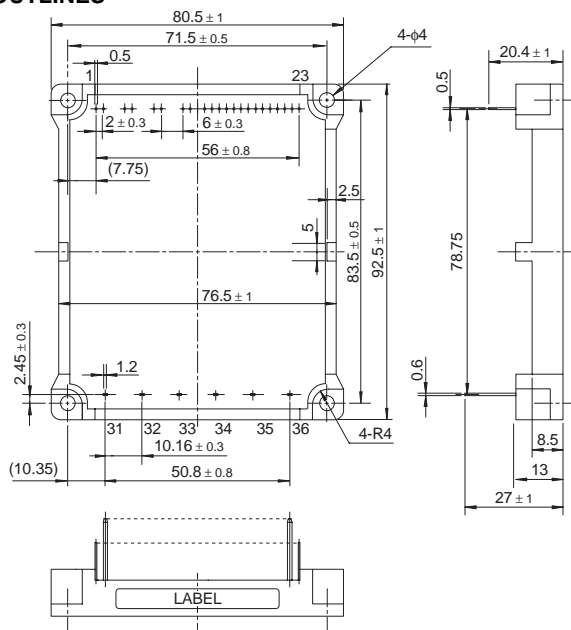

#### Terminals Assignment:

1	CBU+	31	P
2	CBU-	32	B
3	CBV+	33	N
4	CBV-	34	U
5	CBW+	35	V
6	CBW-	36	W
7	GND		
8	VDL		
9	VDH		
10	CL		
11	FO1		
12	FO2		
13	FO3		
14	CU		
15	CV		
16	CW		
17	UP		
18	VP		
19	WP		
20	UN		
21	VN		
22	WN		
23	Br		

(Fig. 1)

**PS12012-A**

**FLAT-BASE TYPE  
INSULATED TYPE**

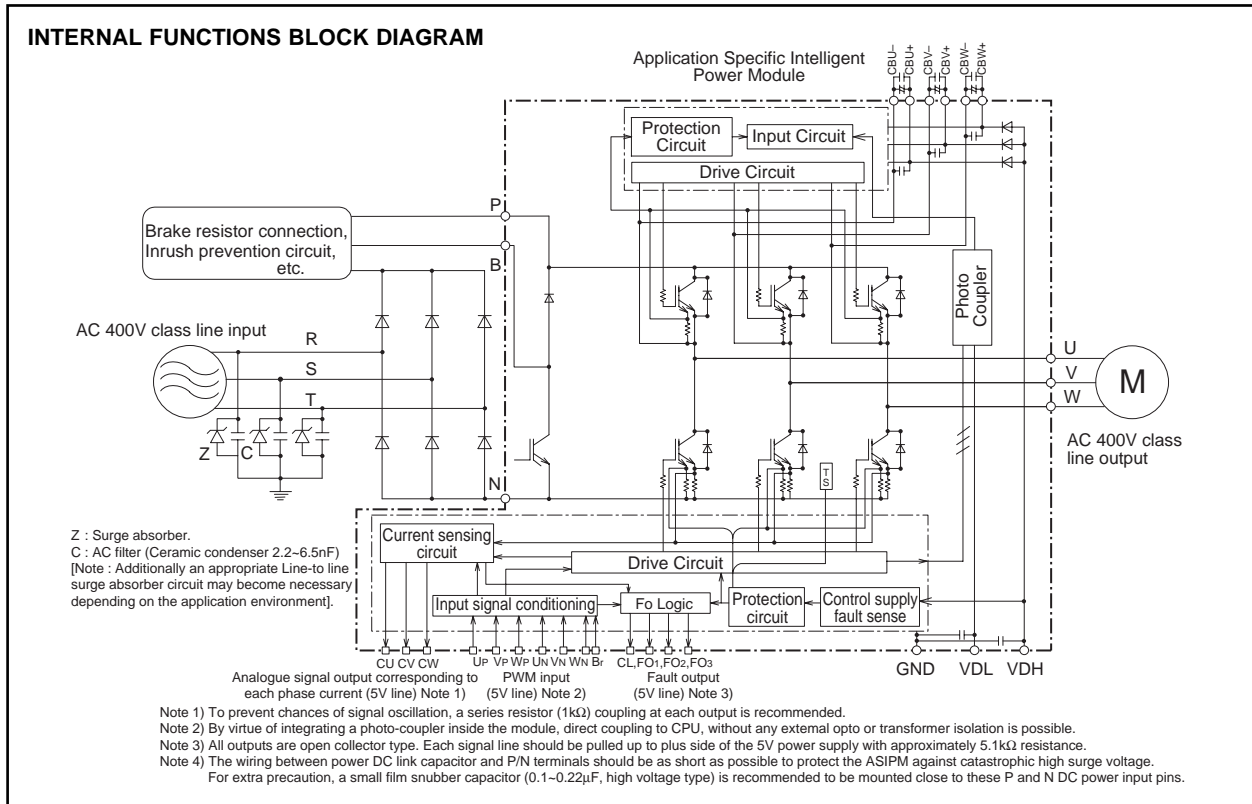

(Fig. 2)

**MAXIMUM RATINGS (Tj = 25°C)**

**INVERTER PART (Including Brake Part)**

Symbol	Item	Condition	Ratings	Unit
VCC	Supply voltage	Applied between P-N	900	V
VCC(surge)	Supply voltage (surge)	Applied between P-N, Surge-value	1000	V
VP or VN	Each output IGBT collector-emitter static voltage	Applied between P-U, V, W, Br or U, V, W, Br-N	1200	V
VP(S) or VN(S)	Each output IGBT collector-emitter surge voltage	Applied between P-U, V, W, Br or U, V, W, Br-N	1200	V
±Ic(±Icp)	Each output IGBT collector current	Tc = 25°C	±5 (±10)	A
Ic(Icp)	Brake IGBT collector current	Note : "( )" means Ic peak value	5 (10)	A
IF(IFP)	Brake diode anode current		5 (10)	A

**CONTROL PART**

Symbol	Item	Condition	Ratings	Unit
VDH, VDB	Supply voltage	Applied between VDH-GND, CBU+-CBU-, CBV+-CBV-, CBW+-CBW-	20	V
VDL	Supply voltage	Applied between VDL-GND	7	V
VCIN	Input signal voltage	Applied between UP · VP · WP · UN · VN · WN · Br-GND	-0.5 ~ VDL+0.5	V
VFO	Fault output supply voltage	Applied between FO1 · FO2 · FO3-GND	-0.5 ~ 7	V
IFO	Fault output current	Sink current of FO1 · FO2 · FO3	15	mA
VCL	Current-limit warning output voltage	Applied between CL-GND	-0.5 ~ 7	V
ICL	CL output current	Sink current of CL	15	mA
ICO	Analogue-current-signal output current	Sink current of CU · CV · CW	±1	mA

# PS12012-A

FLAT-BASE TYPE  
INSULATED TYPE

## TOTAL SYSTEM

Symbol	Item	Condition	Ratings	Unit
T <sub>j</sub>	Junction temperature	(Note 2)	-20 ~ +125	°C
T <sub>stg</sub>	Storage temperature	—	-40 ~ +125	°C
T <sub>c</sub>	Module case operating temperature	(Fig. 3)	-20 ~ +100	°C
Viso	Isolation voltage	60 Hz sinusoidal AC for 1 minute, between all terminals and base plate.	2500	Vrms
—	Mounting torque	Mounting screw: M3.5	0.78 ~ 1.27	N·m

Note 2) : The item defines the maximum junction temperature for the power elements (IGBT/Diode) of the ASIPM to ensure safe operation. However, these power elements can endure instantaneous junction temperature as high as 150°C. To make use of this additional temperature allowance, a detailed study of the exact application conditions is required and, accordingly, necessary information is to be provided before use.

## CASE TEMPERATURE MEASUREMENT POINT (3mm from the base surface)

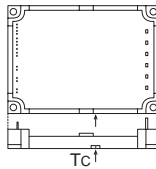

(Fig. 3)

## THERMAL RESISTANCE

Symbol	Item	Condition	Ratings			Unit
			Min.	Typ.	Max.	
R <sub>th(jc)Q</sub>	Junction to case Thermal Resistance	Inverter IGBT (1/6)	—	—	3.0	°C/W
R <sub>th(jc)F</sub>		Inverter FWDi (1/6)	—	—	7.3	°C/W
R <sub>th(jc)QB</sub>		Brake IGBT	—	—	3.0	°C/W
R <sub>th(jc)FB</sub>		Brake FWDi	—	—	7.3	°C/W
R <sub>th(c-f)</sub>	Contact Thermal Resistance	Case to fin, thermal grease applied (1 Module)	—	—	0.040	°C/W

## ELECTRICAL CHARACTERISTICS (T<sub>j</sub> = 25°C, V<sub>DH</sub> = 15V, V<sub>DB</sub> = 15V, V<sub>DL</sub> = 5V unless otherwise noted)

Symbol	Item	Condition	Ratings			Unit
			Min.	Typ.	Max.	
V <sub>CE(sat)</sub>	Collector-emitter saturation voltage	V <sub>DL</sub> = 5V, V <sub>DH</sub> = V <sub>DB</sub> = 15V Input = ON, T <sub>j</sub> = 25°C, I <sub>c</sub> = 5A	—	—	3.6	V
V <sub>EC</sub>	FWDi forward voltage	T <sub>j</sub> = 25°C, I <sub>c</sub> = -5A, Input = OFF	—	—	3.5	V
V <sub>CE(sat)Br</sub>	Brake IGBT Collector-emitter saturation voltage	V <sub>DL</sub> = 5V, V <sub>DH</sub> = 15V Input = ON, T <sub>j</sub> = 25°C, I <sub>c</sub> = 5A	—	—	3.6	V
V <sub>FBr</sub>	Brake diode forward voltage	T <sub>j</sub> = 25°C, I <sub>F</sub> = 5A, Input = OFF	—	—	3.5	V
t <sub>on</sub>	Switching times	1/2 Bridge inductive, Input = ON V <sub>CC</sub> = 600V, I <sub>c</sub> = 5A, T <sub>j</sub> = 125°C V <sub>DL</sub> = 5V, V <sub>DH</sub> = 15V, V <sub>DB</sub> = 15V Note : t <sub>on</sub> , t <sub>off</sub> include delay time of the internal control circuit.	0.3	1.2	2.0	μs
t <sub>c(on)</sub>			—	0.5	1.4	μs
t <sub>off</sub>			—	2.2	4.0	μs
t <sub>c(off)</sub>			—	0.9	1.6	μs
t <sub>rr</sub>	FWD reverse recovery time		—	0.2	—	μs
	Short circuit endurance (Output, Arm, and Load, Short Circuit Modes)	V <sub>CC</sub> ≤ 800V, Input = ON (One-Shot) T <sub>j</sub> = 125°C start 13.5V ≤ V <sub>DH</sub> = V <sub>DB</sub> ≤ 16.5V	<ul style="list-style-type: none"> <li>No destruction</li> <li>FO output by protection operation</li> </ul>			
	Switching SOA	V <sub>CC</sub> ≤ 800V, T <sub>j</sub> ≤ 125°C, I <sub>c</sub> < I <sub>OL</sub> (CL) operation level, Input = ON, 13.5V ≤ V <sub>DH</sub> = V <sub>DB</sub> ≤ 16.5V	<ul style="list-style-type: none"> <li>No destruction</li> <li>No protecting operation</li> <li>No FO output</li> </ul>			
I <sub>DH</sub>	V <sub>DH</sub> Circuit Current	V <sub>DL</sub> = 5V, V <sub>DH</sub> = 15V, V <sub>CIN</sub> = 5V	—	—	150	mA
I <sub>DL</sub>	V <sub>DL</sub> Circuit Current	V <sub>DL</sub> = 5V, V <sub>DH</sub> = 15V, V <sub>CIN</sub> = 5V	—	—	50	mA
V <sub>th(on)</sub>	Input on threshold voltage		0.8	1.4	2.0	V
V <sub>th(off)</sub>	Input off threshold voltage		2.5	3.0	4.0	V
R <sub>i</sub>	Input pull-up resistor	Integrated between input terminal-V <sub>DH</sub>	—	150	—	kΩ

**ELECTRICAL CHARACTERISTICS** (T<sub>j</sub> = 25°C, V<sub>DH</sub> = 15V, V<sub>DB</sub> = 15V, V<sub>DL</sub> = 5V unless otherwise noted)

Symbol	Item	Condition	Ratings			Unit
			Min.	Typ.	Max.	
f <sub>PWM</sub>	PWM input frequency	T <sub>c</sub> ≤ 100°C, T <sub>j</sub> ≤ 125°C	2	—	15	kHz
t <sub>xx</sub>	Allowable input on-pulse width	V <sub>DH</sub> = 15V, V <sub>DL</sub> = 5V, T <sub>c</sub> = -20°C ~ +100°C (Note 3)	2	—	500	μs
t <sub>dead</sub>	Allowable input signal dead time for blocking arm shoot-through	Relates to corresponding inputs (Except brake part) T <sub>c</sub> = -20°C ~ +100°C	4.0	—	—	μs
t <sub>int</sub>	Input inter-lock sensing	Relates to corresponding inputs (Except brake part)	—	65	100	ns
V <sub>CO</sub>	Analogue signal linearity with output current	I <sub>c</sub> = 0A, V <sub>DH</sub> = 15V	1.87	2.27	2.57	V
V <sub>C+(200%)</sub>		I <sub>c</sub> = I <sub>OP(200%)</sub> , V <sub>DL</sub> = 5V	0.77	1.17	1.47	V
V <sub>C-(200%)</sub>		I <sub>c</sub> = -I <sub>OP(200%)</sub> , T <sub>c</sub> = -20 ~ 100°C (Fig.4)	2.97	3.37	3.67	V
ΔV <sub>CO</sub>	Offset change area vs temperature	V <sub>DH</sub> = 15V, V <sub>DL</sub> = 5V, T <sub>c</sub> = -20 ~ 100°C	—	15	—	mV
V <sub>C+</sub>	Analogue signal output voltage limit	I <sub>c</sub> > I <sub>OP(200%)</sub> , V <sub>DH</sub> = 15V, V <sub>DL</sub> = 5V (Fig. 4)	—	—	0.7	V
V <sub>C-</sub>			4.0	—	—	V
ΔV <sub>C(200%)</sub>	Analogue signal overall linear variation	V <sub>CO</sub> -V <sub>C±(200%)</sub>	—	1.1	—	V
r <sub>CH</sub>	Analogue signal data hold accuracy	Correspond to max. 500μs data hold period only, I <sub>c</sub> = I <sub>OP(200%)</sub> (Fig. 5)	-5	—	5	%
t <sub>d(read)</sub>	Analogue signal reading time	After input signal trigger point (Fig. 8)	—	3	—	μs
I <sub>CL(H)</sub>	Signal output current of CL operation	Open collector output	—	—	1	μA
I <sub>CL(L)</sub>			Active	—	1	—
±I <sub>OL</sub>	CL warning operation level	V <sub>DL</sub> = 5V, V <sub>DH</sub> = 15V, T <sub>c</sub> = -20 ~ 100°C (Note 4)	3.23	3.90	4.92	A
SC	Short circuit current trip level	T <sub>j</sub> = 25°C (Fig. 7), (Note 5)	5.7	8.0	11.6	A
OT	Over temperature protection	Trip level	100	110	120	°C
OTr		Reset level	—	90	—	°C
UV <sub>DB</sub>	Supply circuit under and over voltage protection	Trip level	10.0	11.0	12.0	V
UV <sub>DBr</sub>		Reset level	10.5	11.5	12.5	V
UV <sub>DH</sub>		Trip level	11.05	12.00	12.75	V
UV <sub>DHr</sub>		Reset level	11.55	12.50	13.25	V
OVDH		Trip level	18.00	19.20	20.15	V
OVDHr		Reset level	16.50	17.50	18.65	V
t <sub>dv</sub>		Filter time	—	10	—	μs
I <sub>FO(H)</sub>	Fault output current	Open collector output	—	—	1	μA
I <sub>FO(L)</sub>			Active	—	1	—

(Note 3) : (a) Allowable minimum input on-pulse width : This item applies to P-side circuit only.

(b) Allowable maximum input on-pulse width : This item applies to both P-side and N-side circuits excluding the brake circuit.

(Note4) : CL output : The "current limit warning (CL) operation circuit outputs warning signal whenever the arm current exceeds this limit. The circuit is reset automatically by the next input signal and thus, it operates on a pulse-by-pulse scheme.

(Note5) : The short circuit protection works instantaneously when a high short circuit current flows through an internal IGBT rising up momentarily. The protection function is, thus meant primarily to protect the ASIPM against short circuit distraction. Therefore, this function is not recommended to be used for any system load current regulation or any over load control as this might, cause a failure due to excessive temperature rise. Instead, the analogue current output feature or the over load warning feature (CL) should be appropriately used for such current regulation or over load control operation. In other words, the PWM signals to the ASIPM should be shut down, in principle, and not to be restarted before the junction temperature would recover to normal, as soon as a fault is feed back from its FO1 pin of the ASIPM indicating a short circuit situation.

**RECOMMENDED CONDITIONS**

Symbol	Item	Condition	Ratings			Unit
			Min.	Typ.	Max.	
V <sub>CC</sub>	Supply voltage	Applied between P-N	—	600	800	V
V <sub>DH</sub> , V <sub>DB</sub>	Control supply voltage	Applied between V <sub>DH</sub> -GND, C <sub>BU+</sub> -C <sub>BU-</sub> , C <sub>BV+</sub> -C <sub>BV-</sub> , C <sub>BW+</sub> -C <sub>BW-</sub>	13.5	15.0	16.5	V
V <sub>DL</sub>	Control supply voltage	Applied between V <sub>DL</sub> -GND	4.8	5.0	5.2	V
ΔV <sub>DH</sub> , ΔV <sub>DB</sub> , ΔV <sub>DL</sub>	Supply voltage ripple		-1	—	+1	V/μs
V <sub>CIN(on)</sub>	Input ON voltage		—	—	0.3	V
V <sub>CIN(off)</sub>	Input OFF voltage		4.8	—	—	V
f <sub>PWM</sub>	PWM Input frequency	Using application circuit	2	10	15	kHz
t <sub>dead</sub>	Arm shoot-through blocking time	Using application circuit	4.0	—	—	μs

Fig. 4 OUTPUT CURRENT ANALOGUE SIGNALING LINEARITY

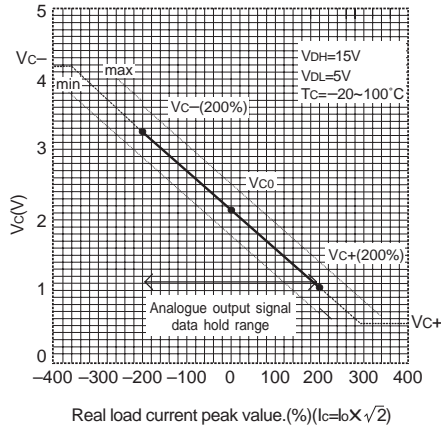
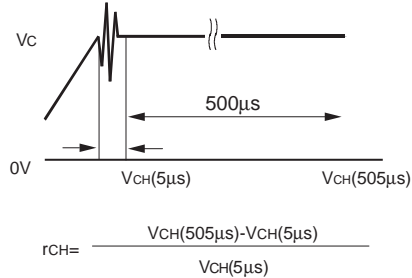
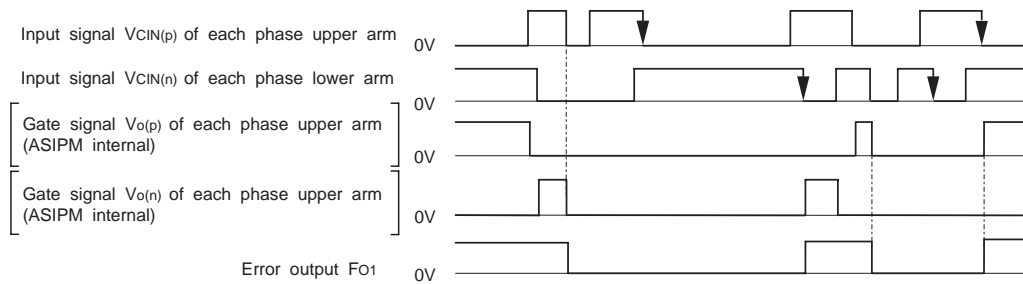

Fig. 5 OUTPUT CURRENT ANALOGUE SIGNALING "DATA HOLD" DEFINITION



Note ; Ringing happens around the point where the signal output voltage changes state from "analogue" to "data hold" due to test circuit arrangement and instrumental trouble. Therefore, the rate of change is measured at a 5 μs delayed point.

Fig. 6 INPUT INTERLOCK OPERATION TIMING CHART



Note : Input interlock protection circuit ; It is operated when the input signals for any upper-arm / lower-arm pair of a phase are simultaneously in "LOW" level.

By this interlocking, both upper and lower IGBTs of this mal-triggered phase are cut off, and "Fo" signal is outputted. After an "input interlock" operation the circuit is latched. The "Fo" is reset by the high-to-low going edge of either an upper-leg, or a lower-leg input, whichever comes in later.

Fig. 7 TIMING CHART AND SHORT CIRCUIT PROTECTION OPERATION

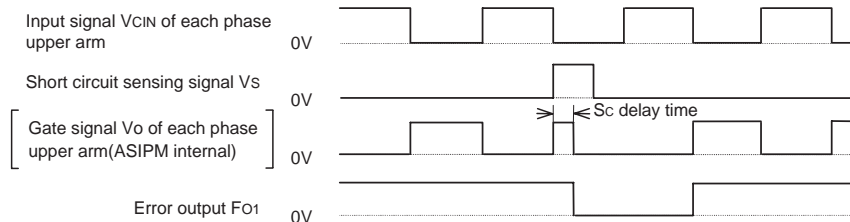

Note : Short circuit protection operation. The protection operates with "Fo" flag and reset on a pulse-by-pulse scheme. The protection by gate shutdown is given only to the IGBT that senses an overload (excluding the IGBT for the "Brake").

**PS12012-A**

FLAT-BASE TYPE  
INSULATED TYPE

**Fig. 8 INVERTER OUTPUT ANALOGUE CURRENT SENSING AND SIGNALING TIMING CHART.**

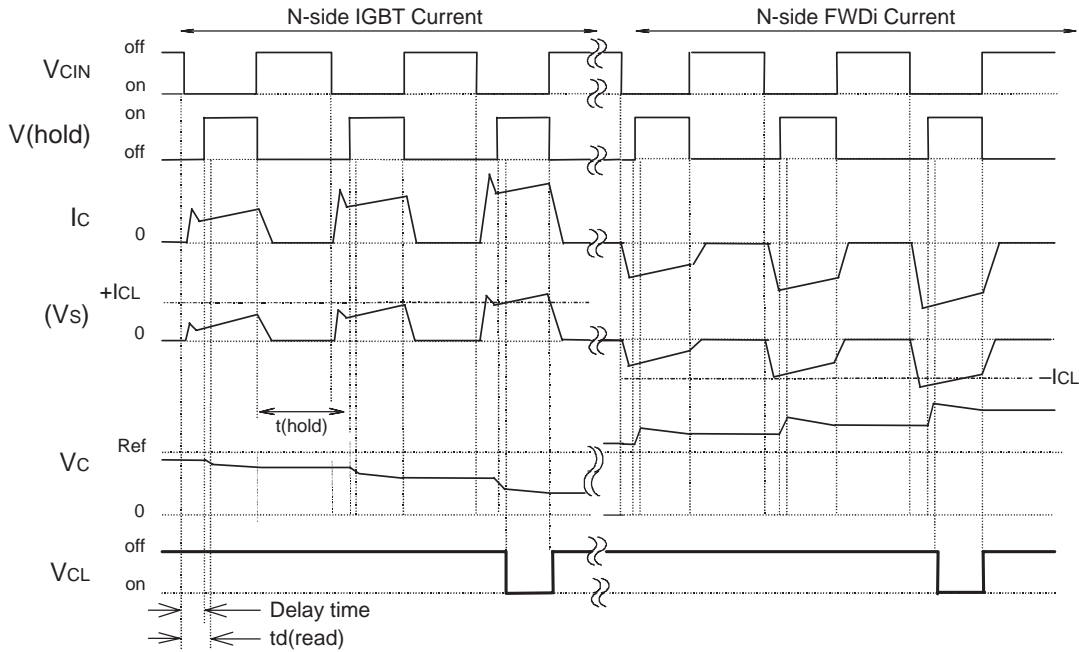

**Fig. 9 START-UP SEQUENCE**

Normally at start-up, Fo and CL output signals will be pulled-up High to V<sub>DL</sub> voltage (OFF level); however, Fo1 output may fall to Low (ON) level at the instant of the first ON input pulse to an N-Side IGBT. This can happen particularly when the boot-strap capacitor is of large size. Fo1 resetting sequence (together with the boot-strap charging sequence) is explained in the following graph

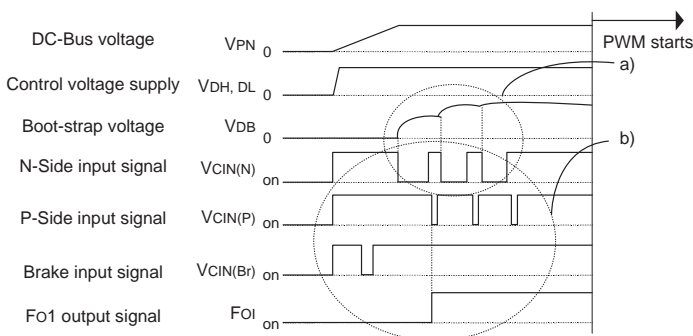

**a) Boot-strap charging scheme :**

Apply a train of short ON pulses at all N-IGBT input pins for adequate charging (pulse width = approx. 20µs number of pulses =10 ~ 500 depending on the boot-strap capacitor size)

**b) Fo1 resetting sequence:**

Apply ON signals to the following input pins : Br → Un/Vn/Wn → Up/Vp/Wp in that order.

**Fig. 10 RECOMMENDED I/O INTERFACE CIRCUIT**

