

PM75RLA060

FLAT-BASE TYPE
INSULATED PACKAGE

PM75RLA060



FEATURE

- a) Adopting new 5th generation IGBT (CSTBT) chip, which performance is improved by 1 μ m fine rule process.
For example, typical $V_{ce(sat)}=1.5V$ @ $T_J=125^\circ C$
- b) I adopt the over-temperature conservation by T_J detection of CSTBT chip, and error output is possible from all each conservation upper and lower arm of IPM.
- c) New small package
Reduce the package size by 10%, thickness by 22% from S-DASH series.
- d) Current rating of brake part increased.
67% for the current rating of inverter part.
 - 3 ϕ 75A, 600V Current-sense IGBT type inverter
 - 50A, 600V Current-sense regenerative brake IGBT
 - Monolithic gate drive & protection logic
 - Detection, protection & status indication circuits for, short-circuit, over-temperature & under-voltage (P-Fo available from upper arm devices)
 - Acoustic noise-less 5.5kW/7.5kW class inverter application
 - UL Recognized Yellow Card No.E80276(N)
File No.E80271

APPLICATION

General purpose inverter, servo drives and other motor controls

PACKAGE OUTLINES

Dimensions in mm

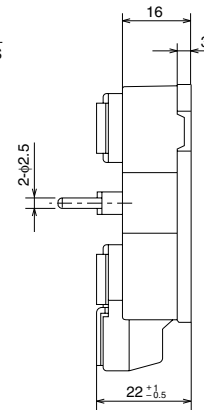
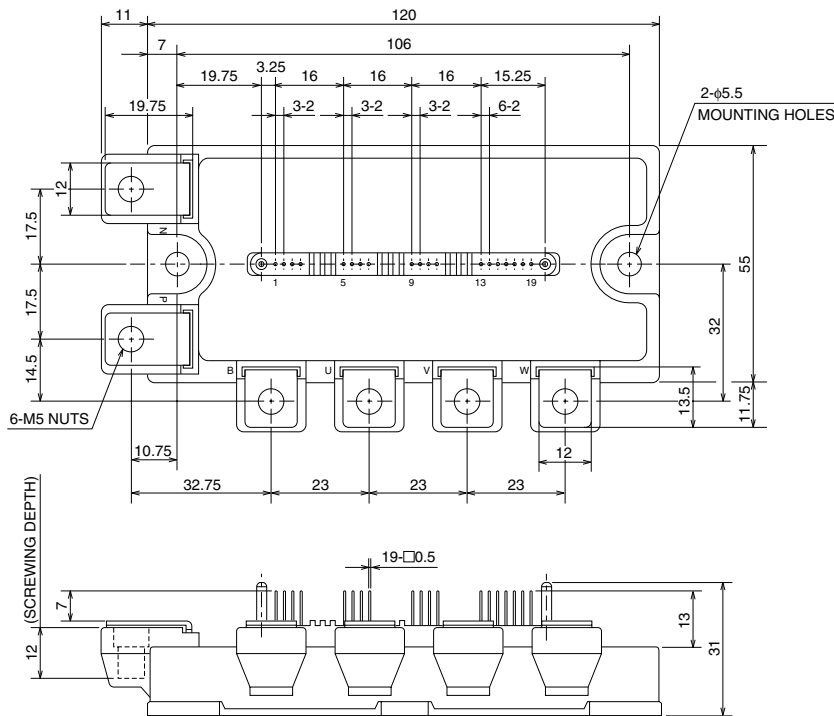

Terminal code

- | | |
|---------|----------|
| 1. VUPC | 11. WP |
| 2. UFO | 12. VVP1 |
| 3. UP | 13. VNC |
| 4. VUP1 | 14. VN1 |
| 5. VVPC | 15. Br |
| 6. VFO | 16. UN |
| 7. VP | 17. VN |
| 8. VVP1 | 18. WN |
| 9. VWPC | 19. Fo |
| 10. WFO | |

PM75RLA060

FLAT-BASE TYPE
INSULATED PACKAGE

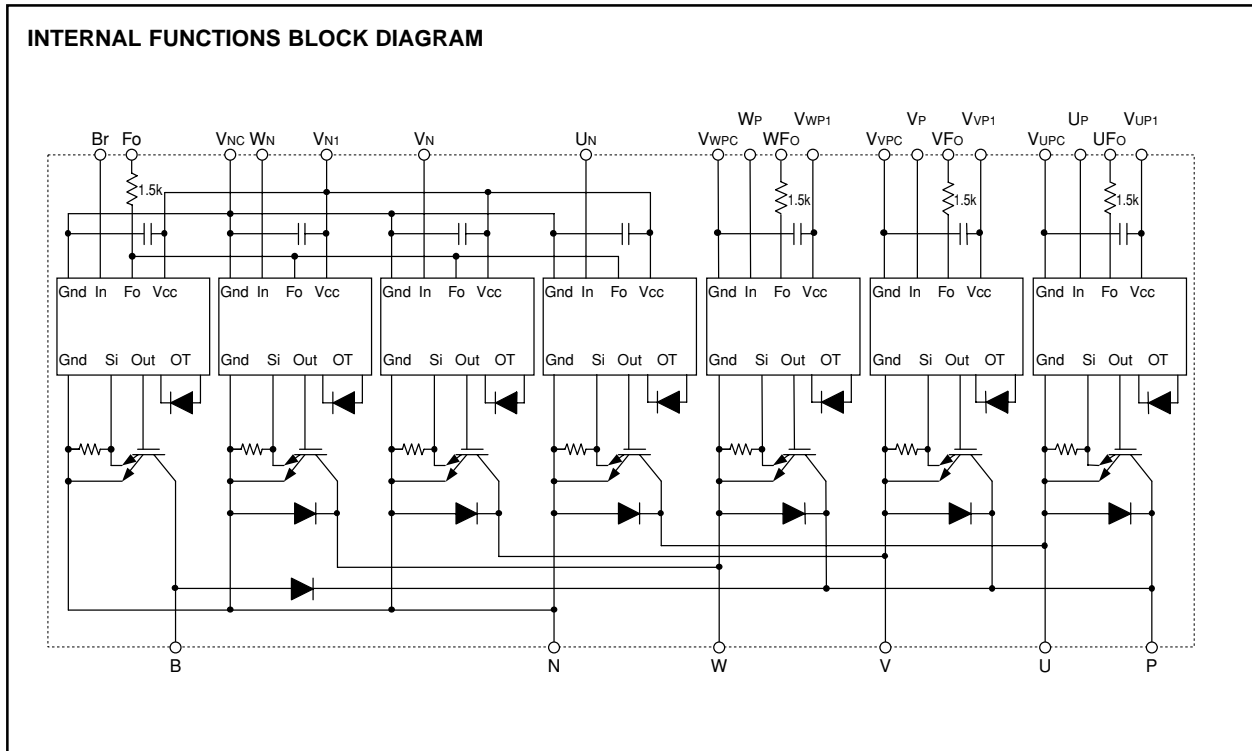

MAXIMUM RATINGS ($T_j = 25^\circ\text{C}$, unless otherwise noted)

INVERTER PART

| Symbol | Parameter | Condition | Ratings | Unit |
|--------------|---------------------------|---|-----------------|------------------|
| V_{CES} | Collector-Emitter Voltage | $V_D = 15\text{V}$, $V_{CIN} = 15\text{V}$ | 600 | V |
| $\pm I_C$ | Collector Current | $T_C = 25^\circ\text{C}$ | 75 | A |
| $\pm I_{CP}$ | Collector Current (Peak) | $T_C = 25^\circ\text{C}$ | 150 | A |
| P_C | Collector Dissipation | $T_C = 25^\circ\text{C}$ (Note-1) | 390 | W |
| T_j | Junction Temperature | | $-20 \sim +150$ | $^\circ\text{C}$ |

BRAKE PART

| Symbol | Parameter | Condition | Ratings | Unit |
|-------------|-------------------------------|---|-----------------|------------------|
| V_{CES} | Collector-Emitter Voltage | $V_D = 15\text{V}$, $V_{CIN} = 15\text{V}$ | 600 | V |
| I_C | Collector Current | $T_C = 25^\circ\text{C}$ | 50 | A |
| I_{CP} | Collector Current (Peak) | $T_C = 25^\circ\text{C}$ | 100 | A |
| P_C | Collector Dissipation | $T_C = 25^\circ\text{C}$ (Note-1) | 297 | W |
| $V_{R(DC)}$ | FWDi Rated DC Reverse Voltage | $T_C = 25^\circ\text{C}$ | 600 | V |
| I_F | FWDi Forward Current | $T_C = 25^\circ\text{C}$ | 50 | A |
| T_j | Junction Temperature | | $-20 \sim +150$ | $^\circ\text{C}$ |

CONTROL PART

| Symbol | Parameter | Condition | Ratings | Unit |
|-----------|-----------------------------|---|---------|------|
| V_D | Supply Voltage | Applied between : $V_{UP1}-V_{UPC}$ $V_{VP1}-V_{VPC}$, $V_{WP1}-V_{WPC}$, $V_{N1}-V_{NC}$ | 20 | V |
| V_{CIN} | Input Voltage | Applied between : U_P-V_{UPC} , V_P-V_{VPC} W_P-V_{WPC} , $U_N \cdot V_N \cdot W_N \cdot B_r-V_{NC}$ | 20 | V |
| V_{FO} | Fault Output Supply Voltage | Applied between : $U_{FO}-V_{UPC}$, $V_{FO}-V_{VPC}$, $W_{FO}-V_{WPC}$ F_O-V_{NC} | 20 | V |
| I_{FO} | Fault Output Current | Sink current at U_{FO} , V_{FO} , W_{FO} , F_O terminals | 20 | mA |

PM75RLA060

FLAT-BASE TYPE
INSULATED PACKAGE

TOTAL SYSTEM

| Symbol | Parameter | Condition | Ratings | Unit |
|------------------|--------------------------------|--|------------|------------------|
| VCC(PROT) | Supply Voltage Protected by SC | V _D = 13.5 ~ 16.5V, Inverter Part, T _j = +125°C Start | 400 | V |
| VCC(surge) | Supply Voltage (Surge) | Applied between : P-N, Surge value | 500 | V |
| T _{stg} | Storage Temperature | | -40 ~ +125 | °C |
| Viso | Isolation Voltage | 60Hz, Sinusoidal, Charged part to Base, AC 1 min. | 2500 | V _{rms} |

THERMAL RESISTANCES

| Symbol | Parameter | Condition | Limits | | | Unit |
|-----------------------|--------------------------------------|--|--------|------|-------|------|
| | | | Min. | Typ. | Max. | |
| R _{th(j-c)Q} | Junction to case Thermal Resistances | Inverter IGBT (per 1 element) (Note-1) | — | — | 0.32* | °C/W |
| R _{th(j-c)F} | | Inverter FWDi (per 1 element) (Note-1) | — | — | 0.53* | |
| R _{th(j-c)Q} | | Brake IGBT (Note-1) | — | — | 0.42* | |
| R _{th(j-c)F} | | Brake FWDi (Note-1) | — | — | 0.71* | |
| R _{th(c-f)} | Contact Thermal Resistance | Case to fin, (per 1 module) Thermal grease applied (Note-1) | — | — | 0.038 | |

* If you use this value, R_{th(f-a)} should be measured just under the chips.

(Note-1) T_c (under the chip) measurement point is below.

(unit : mm)

| axis | arm | UP | | VP | | WP | | UN | | VN | | WN | | Br | |
|------|-----|------|------|------|------|------|------|------|------|------|------|------|------|------|------|
| | | IGBT | FWDi | IGBT | FWDi | IGBT | FWDi | IGBT | FWDi | IGBT | FWDi | IGBT | FWDi | IGBT | FWDi |
| X | | 28.7 | 28.7 | 65.2 | 65.2 | 85.3 | 85.3 | 38.0 | 38.0 | 55.4 | 55.4 | 75.5 | 75.5 | 19.0 | 23.0 |
| Y | | -6.6 | 0.8 | -6.6 | 2.5 | -6.6 | 2.5 | 4.6 | -4.5 | 4.6 | -4.5 | 4.6 | -4.5 | -7.3 | 6.6 |

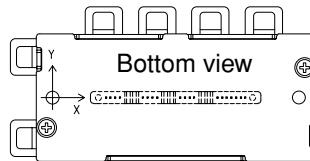

ELECTRICAL CHARACTERISTICS (T_j = 25°C, unless otherwise noted)

INVERTER PART

| Symbol | Parameter | Condition | Limits | | | Unit | |
|----------------------|--------------------------------------|--|------------------------|------|------|------|----|
| | | | Min. | Typ. | Max. | | |
| V _{CE(sat)} | Collector-Emitter Saturation Voltage | V _D = 15V, I _C = 75A V _{CIN} = 0V (Fig. 1) | T _j = 25°C | — | 1.6 | 2.1 | V |
| | | | T _j = 125°C | — | 1.5 | 2.0 | |
| V _{EC} | FWDi Forward Voltage | -I _C = 75A, V _D = 15V, V _{CIN} = 15V (Fig. 2) | — | 2.2 | 3.3 | V | |
| t _{on} | Switching Time | V _D = 15V, V _{CIN} = 0V↔15V V _{CC} = 300V, I _C = 75A T _j = 125°C Inductive Load (Fig. 3,4) | 0.5 | 1.0 | 2.4 | μs | |
| t _{tr} | | | — | 0.2 | 0.4 | | |
| t _{c(on)} | | | — | 0.4 | 1.0 | | |
| t _{off} | | | — | 1.2 | 2.5 | | |
| t _{c(off)} | | | — | 0.5 | 1.0 | | |
| I _{CES} | Collector-Emitter Cutoff Current | V _{CE} = V _{CES} , V _{CIN} = 15V (Fig. 5) | T _j = 25°C | — | — | 1 | mA |
| | | | T _j = 125°C | — | — | 10 | |

PM75RLA060**FLAT-BASE TYPE
INSULATED PACKAGE****BRAKE PART**

| Symbol | Parameter | Condition | Limits | | | Unit | |
|----------------------|--------------------------------------|--|------------------------|------|------|------|----|
| | | | Min. | Typ. | Max. | | |
| V _{CE(sat)} | Collector-Emitter Saturation Voltage | V _D = 15V, I _C = 50A V _{CIN} = 0V (Fig. 1) | T _J = 25°C | — | 1.6 | 2.1 | V |
| | | | T _J = 125°C | — | 1.5 | 2.0 | |
| V _{FM} | FWDi Forward Voltage | I _F = 50A (Fig. 2) | — | 2.2 | 3.3 | V | |
| I _{CES} | Collector-Emitter Cutoff Current | V _{CE} = V _{CES} , V _{CIN} = 15V (Fig. 5) | T _J = 25°C | — | — | 1 | mA |
| | | | T _J = 125°C | — | — | 10 | |

CONTROL PART

| Symbol | Parameter | Condition | Limits | | | Unit | |
|----------------------|---|--|---------------------|------|------|------|----|
| | | | Min. | Typ. | Max. | | |
| I _D | Circuit Current | V _D = 15V, V _{CIN} = 15V | V _{N1-VNC} | — | 20 | 30 | mA |
| | | | V _{P1-VPC} | — | 5 | 10 | |
| V _{th(ON)} | Input ON Threshold Voltage | Applied between : UP-VUPC, VP-VVPC, WP-VWPC UN • VN • WN • Br-VNC | 1.2 | 1.5 | 1.8 | V | |
| V _{th(OFF)} | Input OFF Threshold Voltage | | 1.7 | 2.0 | 2.3 | | |
| SC | Short Circuit Trip Level | -20 ≤ T _J ≤ 125°C, V _D = 15V (Fig. 3,6) | Inverter part | 150 | — | — | A |
| | | | Brake part | 100 | — | — | |
| t _{off(SC)} | Short Circuit Current Delay Time | V _D = 15V (Fig. 3,6) | — | 0.2 | — | μs | |
| OT | Over Temperature Protection | V _D = 15V Detect T _J of IGBT chip | Trip level | 135 | 145 | — | °C |
| | | | Reset level | — | 125 | — | |
| UV | Supply Circuit Under-Voltage Protection | -20 ≤ T _J ≤ 125°C | Trip level | 11.5 | 12.0 | 12.5 | V |
| | | | Reset level | — | 12.5 | — | |
| I _{FO(H)} | Fault Output Current | V _D = 15V, V _{FO} = 15V (Note-2) | — | — | 0.01 | mA | |
| I _{FO(L)} | | | — | 10 | 15 | | |
| t _{FO} | Minimum Fault Output Pulse Width | V _D = 15V (Note-2) | 1.0 | 1.8 | — | ms | |

(Note-2) Fault output is given only when the internal SC, OT & UV protections schemes of either upper or lower arm device operate to protect it.

MECHANICAL RATINGS AND CHARACTERISTICS

| Symbol | Parameter | Condition | Limits | | | Unit |
|--------|-----------------|--------------------------|--------|------|------|-------|
| | | | Min. | Typ. | Max. | |
| — | Mounting torque | Main terminal screw : M5 | 2.5 | 3.0 | 3.5 | N • m |
| — | Mounting torque | Mounting part screw : M5 | 2.5 | 3.0 | 3.5 | N • m |
| — | Weight | — | — | 380 | — | g |

RECOMMENDED CONDITIONS FOR USE

| Symbol | Parameter | Condition | Recommended value | Unit |
|-----------------------|---------------------------------|---|-------------------|------|
| V _{CC} | Supply Voltage | Applied across P-N terminals | ≤ 400 | V |
| V _D | Control Supply Voltage | Applied between : V _{UP1-VUPC} , V _{VP1-VVPC} V _{WP1-VWPC} , V _{N1-VNC} (Note-3) | 15 ± 1.5 | V |
| V _{CIN(ON)} | Input ON Voltage | Applied between : UP-VUPC, VP-VVPC, WP-VWPC UN • VN • WN • Br-VNC | ≤ 0.8 | V |
| V _{CIN(OFF)} | Input OFF Voltage | | ≥ 9.0 | |
| f _{PWM} | PWM Input Frequency | Using Application Circuit of Fig. 8 | ≤ 20 | kHz |
| t _{dead} | Arm Shoot-through Blocking Time | For IPM's each input signals (Fig. 7) | ≥ 2.0 | μs |

(Note-3) With ripple satisfying the following conditions: dv/dt swing ≤ ±5V/μs, Variation ≤ 2V peak to peak

PM75RLA060

FLAT-BASE TYPE
INSULATED PACKAGE

PRECAUTIONS FOR TESTING

1. Before applying any control supply voltage (V_D), the input terminals should be pulled up by resistors, etc. to their corresponding supply voltage and each input signal should be kept off state.
After this, the specified ON and OFF level setting for each input signal should be done.
2. When performing "SC" tests, the turn-off surge voltage spike at the corresponding protection operation should not be allowed to rise above V_{CES} rating of the device.
(These test should not be done by using a curve tracer or its equivalent.)

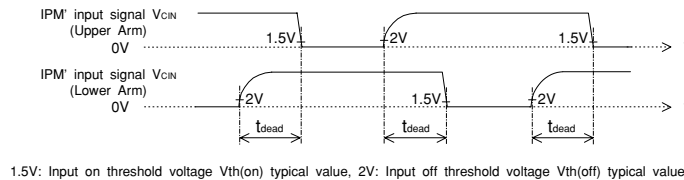
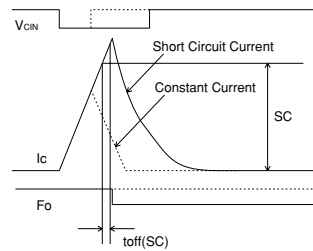
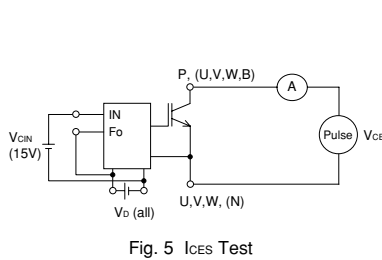
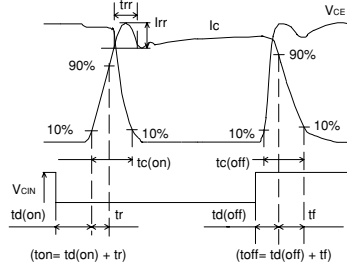
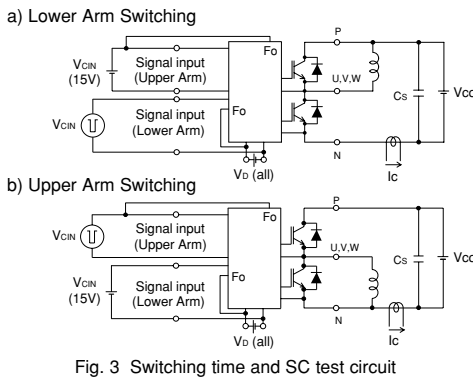
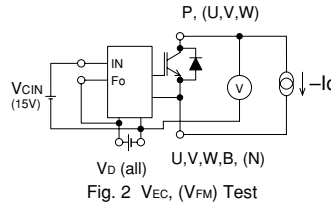
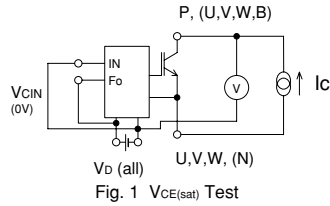

PM75RLA060

FLAT-BASE TYPE
INSULATED PACKAGE

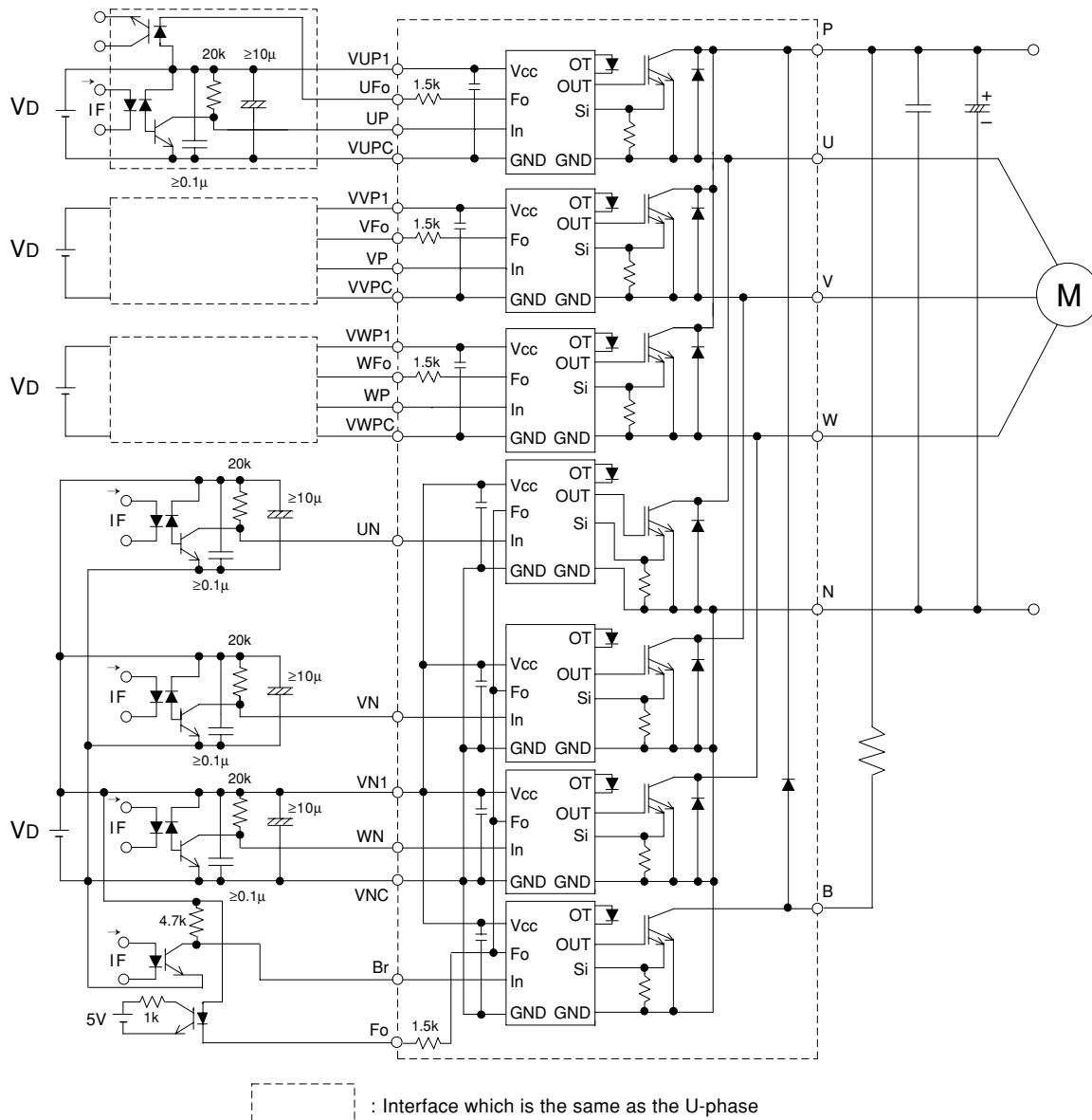

Fig. 8 Application Example Circuit

NOTES FOR STABLE AND SAFE OPERATION ;

- Design the PCB pattern to minimize wiring length between opto-coupler and IPM's input terminal, and also to minimize the stray capacity between the input and output wirings of opto-coupler.
- Connect low impedance capacitor between the Vcc and GND terminal of each fast switching opto-coupler.
- Fast switching opto-couplers: $t_{PLH}, t_{PHL} \leq 0.8\mu s$, Use High CMR type.
- Slow switching opto-coupler: CTR > 100%
- Use 4 isolated control power supplies (VD). Also, care should be taken to minimize the instantaneous voltage charge of the power supply.
- Make inductance of DC bus line as small as possible, and minimize surge voltage using snubber capacitor between P and N terminal.
- Use line noise filter capacitor (ex. 4.7nF) between each input AC line and ground to reject common-mode noise from AC line and improve noise immunity of the system.

PM75RLA060

FLAT-BASE TYPE
INSULATED PACKAGE

PERFORMANCE CURVES

**OUTPUT CHARACTERISTICS
(INVERTER PART - TYPICAL)**

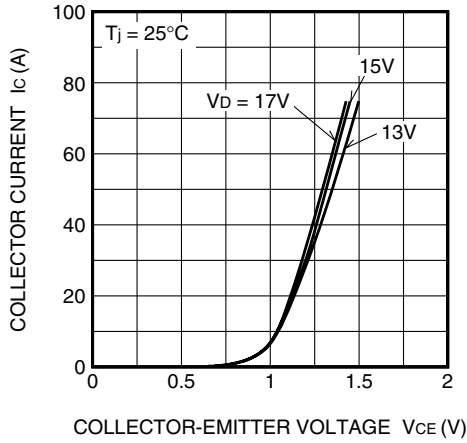

**COLLECTOR-EMITTER SATURATION
VOLTAGE (VS. I_c) CHARACTERISTICS
(INVERTER PART - TYPICAL)**

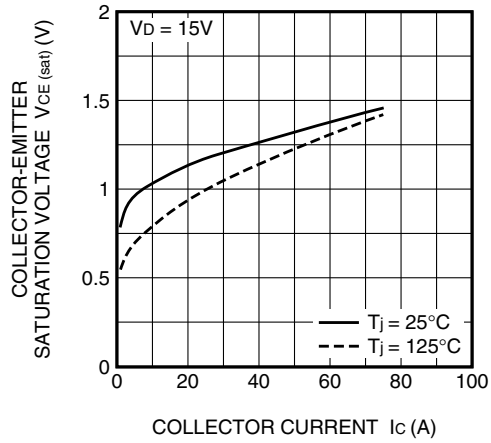

**COLLECTOR-EMITTER SATURATION
VOLTAGE (VS. V_d) CHARACTERISTICS
(INVERTER PART - TYPICAL)**

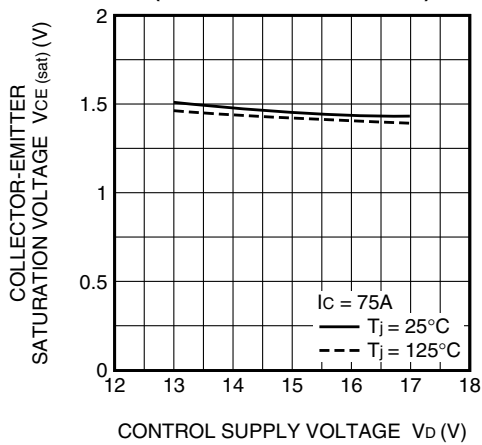

**SWITCHING TIME CHARACTERISTICS
(TYPICAL)**

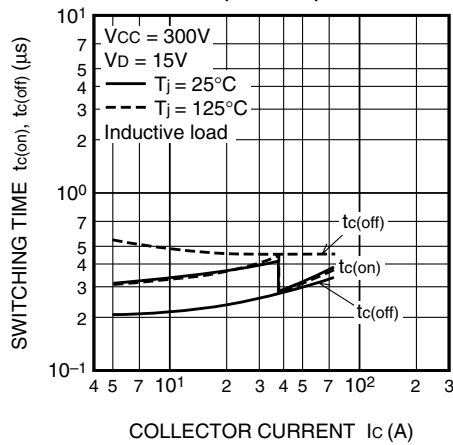

**SWITCHING TIME CHARACTERISTICS
(TYPICAL)**

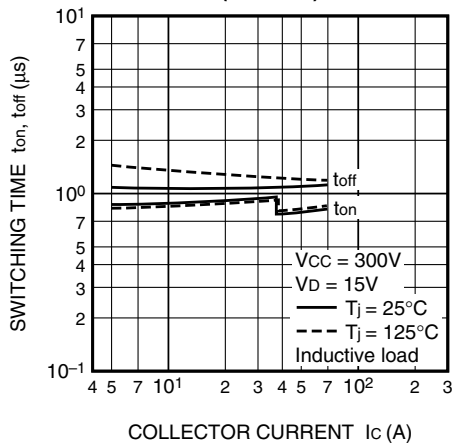

**SWITCHING LOSS CHARACTERISTICS
(TYPICAL)**

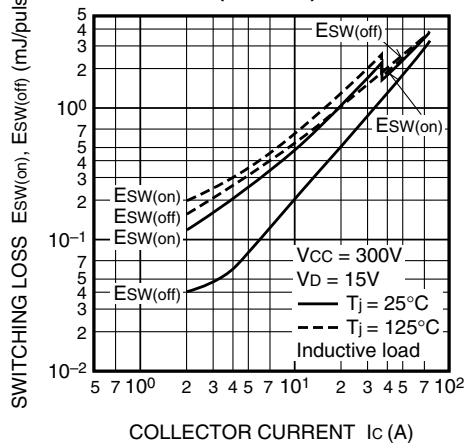

PM75RLA060

FLAT-BASE TYPE
INSULATED PACKAGE

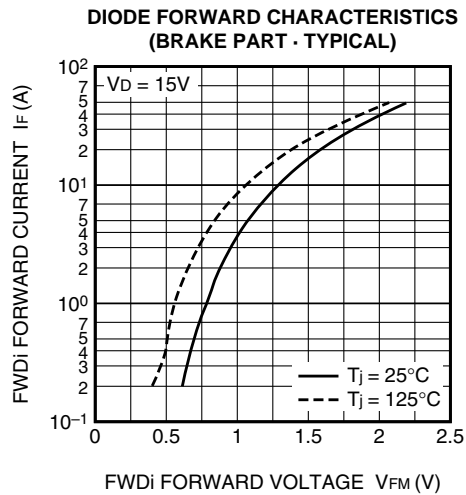
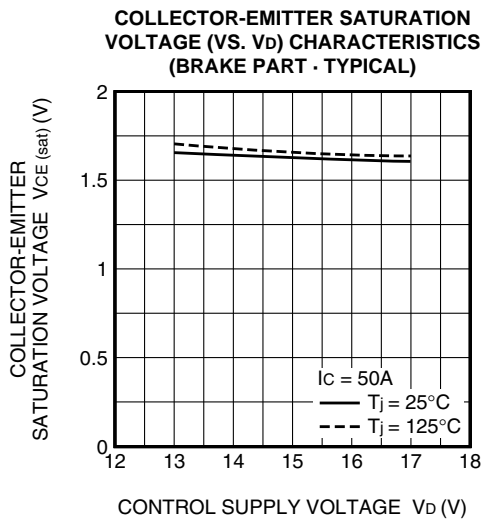
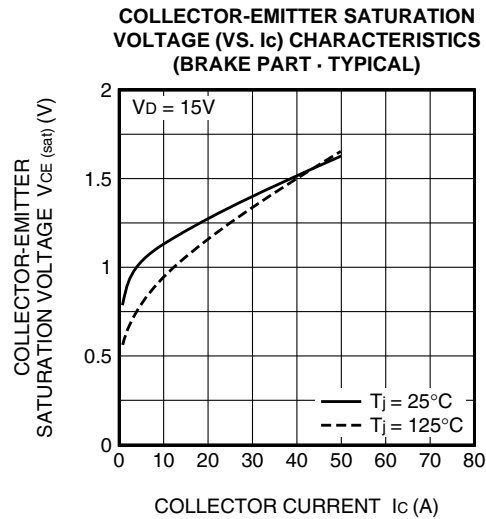
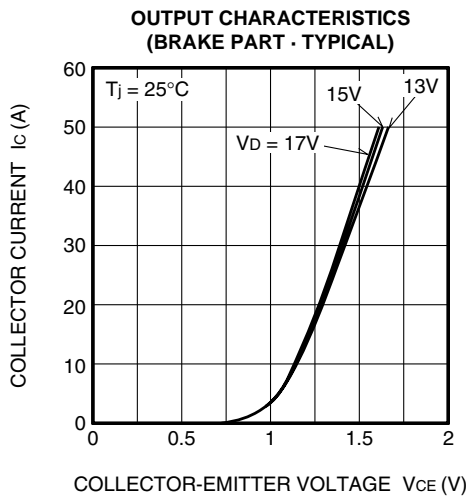
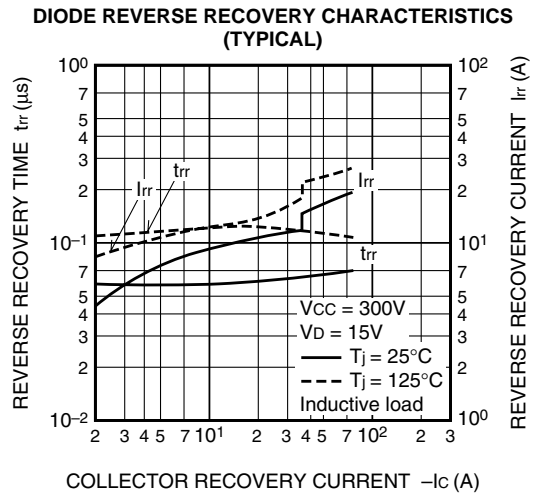
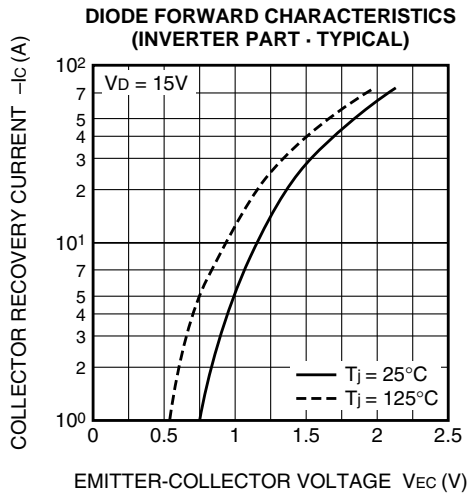

PM75RLA060

FLAT-BASE TYPE
INSULATED PACKAGE

**Id VS. fc CHARACTERISTICS
(TYPICAL)**

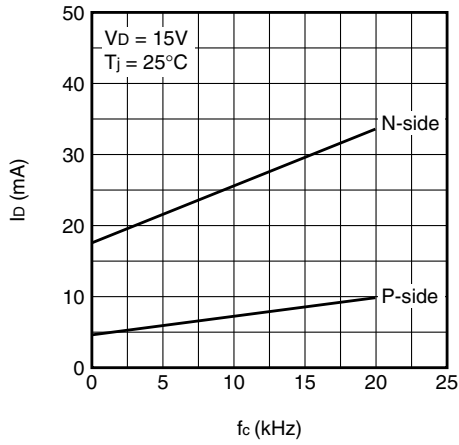

**TRANSIENT THERMAL IMPEDANCE CHARACTERISTICS
(INVERTER PART)**

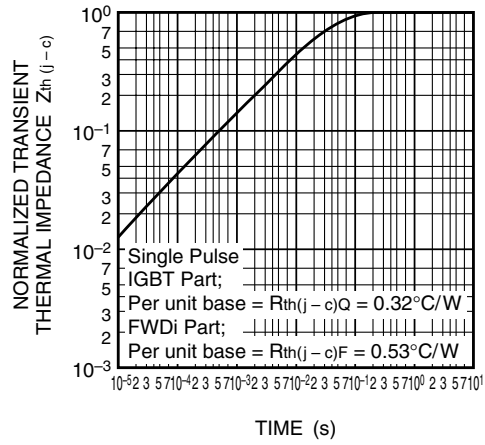

**TRANSIENT THERMAL IMPEDANCE CHARACTERISTICS
(BRAKE PART)**

