

# PM50RSK060

FLAT-BASE TYPE  
INSULATED PACKAGE

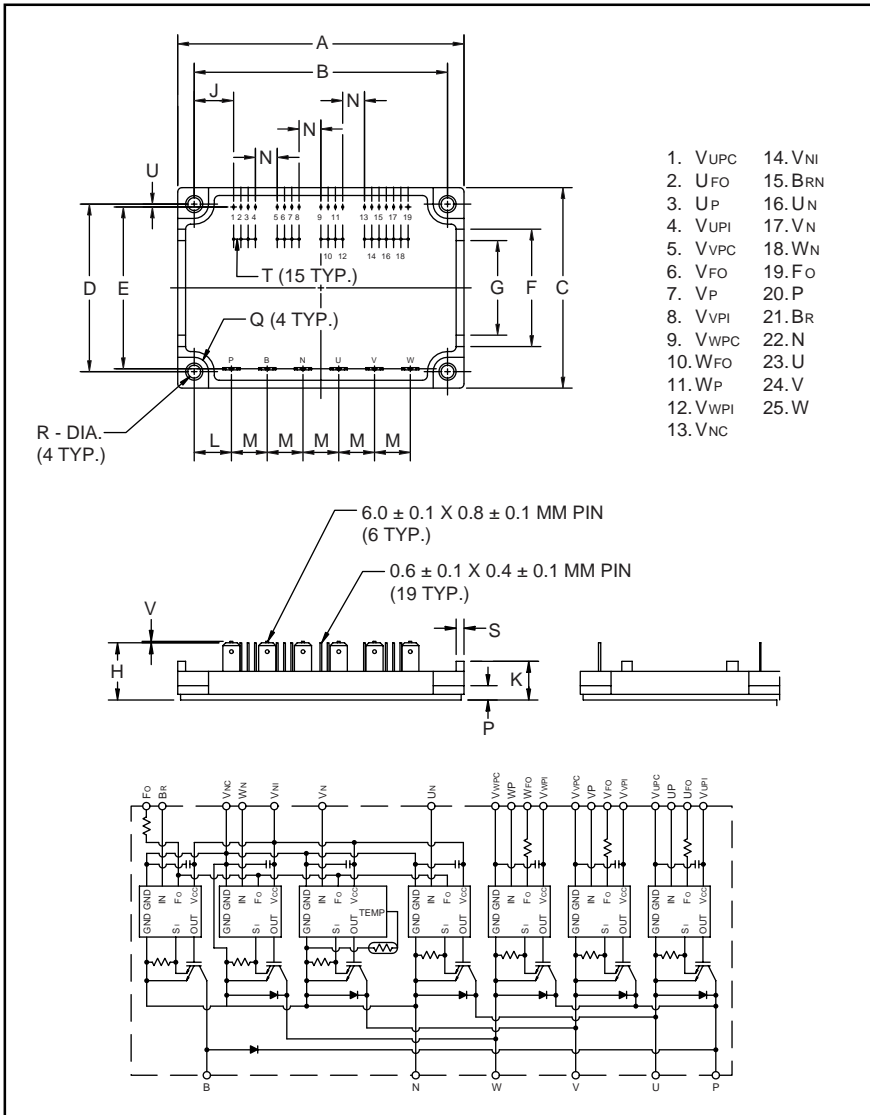

- |          |         |
|----------|---------|
| 1. VUPC  | 14. VNI |
| 2. UFO   | 15. BRN |
| 3. UP    | 16. UN  |
| 4. VUPI  | 17. VN  |
| 5. VVPC  | 18. WN  |
| 6. VFO   | 19. FO  |
| 7. VP    | 20. P   |
| 8. VVPI  | 21. BR  |
| 9. VWPC  | 22. N   |
| 10. WFO  | 23. U   |
| 11. WP   | 24. V   |
| 12. VWPI | 25. W   |
| 13. VNC  |         |



**Description:**

Mitsubishi Intelligent Power Modules are isolated base modules designed for power switching applications operating at frequencies to 20kHz. Built-in control circuits provide optimum gate drive and protection for the IGBT and free-wheel diode power devices.

**Features:**

- Complete Output Power Circuit
- Gate Drive Circuit
- Protection Logic
  - Short Circuit
  - Over Current
  - Over Temperature
  - Under Voltage

**Applications:**

- Inverters
- UPS
- Motion/Servo Control
- Power Supplies

**Ordering Information:**

Example: Select the complete part number from the table below -i.e. PM50RSK060 is a 600V, 50 Ampere Intelligent Power Module.

Type	Current Rating Amperes	V <sub>CES</sub> Volts (x 10)
PM	50	60

**Outline Drawing and Circuit Diagram**

Dimensions	Inches	Millimeters
A	3.96±0.04	100.5±1.0
B	3.48±0.02	88.5±0.5
C	2.76±0.04	70.0±1.0
D	2.30±0.02	58.5±0.5
E	2.22±0.02	56.5±0.5
F	1.61	41.0
G	1.30	33.0
H	0.75±0.04	19.0±1.0
J	0.542	13.77
K	0.53	13.5

Dimensions	Inches	Millimeters
L	0.51	13.0
M	0.49±0.01	12.5±0.25
N	0.300±0.01	7.62
P	0.22	5.5
Q	0.20 Rad.	Rad. 5.0
R	0.18 Dia.	Dia. 4.5
S	0.108	2.75
T	0.100±0.01	2.54±0.25
U	0.030	0.75
V	0.04	1.0

# PM50RSK060

FLAT-BASE TYPE  
INSULATED PACKAGE

## Absolute Maximum Ratings, $T_j = 25^\circ\text{C}$ unless otherwise specified

Ratings	Symbol	PM50RSK060	Units
Power Device Junction Temperature	$T_j$	-20 to 150	$^\circ\text{C}$
Storage Temperature	$T_{\text{stg}}$	-40 to 125	$^\circ\text{C}$
Case Operating Temperature	$T_C$	-20 to 100	$^\circ\text{C}$
Mounting Torque, M4 Mounting Screws	—	0.98 ~ 1.47	$\text{N} \cdot \text{m}$
Module Weight (Typical)	—	110	Grams
Supply Voltage Protected by OC and SC ( $V_D = 13.5 - 16.5\text{V}$ , Inverter Part, $T_j = 125^\circ\text{C}$ )	$V_{\text{CC(prot.)}}$	400	Volts
Isolation Voltage (Main Terminal to Baseplate, AC 1 min.)	$V_{\text{iso}}$	2500	Vrms

## Control Sector

Supply Voltage (Applied between $V_{\text{UP1}}-V_{\text{UPC}}$ , $V_{\text{VP1}}-V_{\text{VPC}}$ , $V_{\text{WP1}}-V_{\text{WPC}}$ , $V_{\text{N1}}-V_{\text{NC}}$ )	$V_D$	20	Volts
Input Voltage (Applied between $U_P-V_{\text{UPC}}$ , $V_P-V_{\text{VPC}}$ , $W_P-V_{\text{WPC}}$ , $U_N \cdot V_N \cdot W_N-V_{\text{NC}}$ )	$V_{\text{CIN}}$	20	Volts
Fault Output Supply Voltage (Applied between $U_{\text{FO}}-V_{\text{UPC}}$ , $V_{\text{FO}}-V_{\text{VPC}}$ , $W_{\text{FO}}-V_{\text{WPC}}$ , $F_O-V_{\text{NC}}$ )	$V_{\text{FO}}$	20	Volts
Fault Output Current (Sink Current of $U_{\text{FO}}$ , $V_{\text{FO}}$ , $W_{\text{FO}}$ and $F_O$ Terminal)	$I_{\text{FO}}$	20	mA

## IGBT Inverter Sector

Collector-Emitter Voltage ( $V_D = 15\text{V}$ , $V_{\text{CIN}} = 15\text{V}$ )	$V_{\text{CES}}$	600	Volts
Collector Current, $\pm$	$I_C$	50	Amperes
Peak Collector Current, $\pm$	$I_{\text{CP}}$	100	Amperes
Supply Voltage (Applied between P - N)	$V_{\text{CC}}$	450	Volts
Supply Voltage, Surge (Applied between P - N)	$V_{\text{CC(surge)}}$	500	Volts
Collector Dissipation	$P_C$	100	Watts

## Brake Sector

Collector-Emitter Voltage ( $V_D = 15\text{V}$ , $V_{\text{CIN}} = 15\text{V}$ )	$V_{\text{CES}}$	600	Volts
Collector Current, ( $T_C = 25^\circ\text{C}$ )	$I_C$	15	Amperes
Peak Collector Current, ( $T_C = 25^\circ\text{C}$ )	$I_{\text{CP}}$	30	Amperes
Supply Voltage (Applied between P - N)	$V_{\text{CC}}$	450	Volts
Supply Voltage, Surge (Applied between P - N)	$V_{\text{CC(surge)}}$	500	Volts
Collector Dissipation	$P_C$	43	Watts
Diode Forward Current	$I_F$	15	Amperes
Diode DC Reverse Voltage	$V_{\text{R(DC)}}$	600	Volts

**PM50RSK060**

FLAT-BASE TYPE  
INSULATED PACKAGE

**Electrical and Mechanical Characteristics,  $T_j = 25^\circ\text{C}$  unless otherwise specified**

Characteristics	Symbol	Test Conditions	Min.	Typ.	Max.	Units
Control Sector						
Over Current Trip Level Inverter Part	OC	$-20^\circ\text{C} \leq T \leq 125^\circ\text{C}$ , $V_D = 15\text{V}$	65	88	—	Amperes
Over Current Trip Level Brake Part			18	26	—	Amperes
Short Circuit Trip Level Inverter Part	SC	$-20^\circ\text{C} \leq T \leq 125^\circ\text{C}$ , $V_D = 15\text{V}$	—	132	—	Amperes
Short Circuit Trip Level Brake Part			—	39	—	Amperes
Over Current Delay Time	$t_{\text{off(OC)}}$	$V_D = 15\text{V}$	—	10	—	$\mu\text{s}$
Over Temperature Protection	OT	Trip Level	100	110	120	$^\circ\text{C}$
	$OT_r$	Reset Level	—	90	—	$^\circ\text{C}$
Supply Circuit Under Voltage Protection	UV	Trip Level	11.5	12.0	12.5	Volts
	$UV_r$	Reset Level	—	12.5	—	Volts
Supply Voltage	$V_D$	Applied between $V_{UP1}-V_{UPC}$ , $V_{VP1}-V_{VPC}$ , $V_{WP1}-V_{WPC}$ , $V_{N1}-V_{NC}$	13.5	15	16.5	Volts
Circuit Current	$I_D$	$V_D = 15\text{V}$ , $V_{CIN} = 15\text{V}$ , $V_{N1}-V_{NC}$	—	44	60	mA
		$V_D = 15\text{V}$ , $V_{CIN} = 15\text{V}$ , $V_{XP1}-V_{XPC}$	—	13	18	mA
Input ON Threshold Voltage	$V_{\text{th(on)}}$	Applied between	1.2	1.5	1.8	Volts
Input OFF Threshold Voltage	$V_{\text{th(off)}}$	$U_P-V_{UPC}$ , $V_P-V_{VPC}$ , $W_P-V_{WPC}$ , $U_N \cdot V_N \cdot W_N \cdot B_r-V_{NC}$	1.7	2.0	2.3	Volts
PWM Input Frequency	$f_{\text{PWM}}$	3- $\phi$ Sinusoidal	—	15	20	kHz
Fault Output Current	$I_{\text{FO(H)}}$	$V_D = 15\text{V}$ , $V_{\text{FO}} = 15\text{V}$	—	—	0.01	mA
	$I_{\text{FO(L)}}$	$V_D = 15\text{V}$ , $V_{\text{FO}} = 15\text{V}$	—	10	15	mA
Minimum Fault Output Pulse Width	$t_{\text{FO}}$	$V_D = 15\text{V}$	1.0	1.8	—	ms

**PM50RSK060**

FLAT-BASE TYPE  
INSULATED PACKAGE

**Electrical and Mechanical Characteristics,  $T_j = 25^\circ\text{C}$  unless otherwise specified**

Characteristics	Symbol	Test Conditions	Min.	Typ.	Max.	Units
<b>IGBT Inverter Sector</b>						
Collector Cutoff Current	$I_{CES}$	$V_{CE} = V_{CES}, T_j = 25^\circ\text{C}$	—	—	1.0	mA
		$V_{CE} = V_{CES}, T_j = 125^\circ\text{C}$	—	—	10	mA
Diode Forward Voltage	$V_{EC}$	$-I_C = 50\text{A}, V_D = 15\text{V}, V_{CIN} = 15\text{V}$	—	2.2	3.3	Volts
Collector-Emitter Saturation Voltage	$V_{CE(sat)}$	$V_D = 15\text{V}, V_{CIN} = 0\text{V}, I_C = 50\text{A}$	—	1.8	2.7	Volts
		$V_D = 15\text{V}, V_{CIN} = 0\text{V}, I_C = 50\text{A}, T_j = 125^\circ\text{C}$	—	1.85	2.78	Volts
Inductive Load Switching Times	$t_{on}$		0.4	0.8	2.0	$\mu\text{s}$
	$t_{rr}$	$V_D = 15\text{V}, V_{CIN} = 0 \leftrightarrow 15\text{V}$	—	0.15	0.3	$\mu\text{s}$
	$t_{C(on)}$	$V_{CC} = 300\text{V}, I_C = 50\text{A}$	—	0.4	1.0	$\mu\text{s}$
	$t_{off}$	$T_j = 125^\circ\text{C}$	—	2.0	2.9	$\mu\text{s}$
	$t_{C(off)}$		—	0.5	1.0	$\mu\text{s}$

**Brake Sector**

Collector-Emitter Saturation Voltage	$V_{CE(sat)}$	$V_D = 15\text{V}, V_{CIN} = 0\text{V}, I_C = 15\text{A}, T_j = 25^\circ\text{C}$	—	2.6	3.5	Volts
		$V_D = 15\text{V}, V_{CIN} = 0\text{V}, I_C = 15\text{A}, T_j = 125^\circ\text{C}$	—	3.0	4.0	Volts
Diode Forward Voltage	$V_{FM}$	$I_F = 15\text{A}, V_D = 15\text{V}, V_{CIN} = 5\text{V}$	—	1.7	2.2	Volts
Collector Cutoff Current	$I_{CES}$	$V_{CE} = V_{CES}, T_j = 25^\circ\text{C}$	—	—	1	mA
		$V_{CE} = V_{CES}, T_j = 125^\circ\text{C}$	—	—	10	mA

**PM50RSK060**

FLAT-BASE TYPE  
INSULATED PACKAGE

**Thermal Characteristics**

Characteristic	Symbol	Condition	Min.	Typ.	Max.	Units
Junction to Case Thermal Resistance	$R_{th(j-c)Q}$	Each Inverter IGBT	—	—	1.25	°C/Watt
	$R_{th(j-c)F}$	Each Inverter FWDi	—	—	3.0	°C/Watt
	$R_{th(c-f)Q}$	Each Brake IGBT	—	—	2.9	°C/Watt
	$R_{th(c-f)F}$	Each Brake FWDi	—	—	5.4	°C/Watt
Contact Thermal Resistance	$R_{th(c-f)}$	Case to Fin Per Module, Thermal Grease Applied	—	—	0.038	°C/Watt

**Recommended Conditions for Use**

Characteristic	Symbol	Condition	Value	Units
Supply Voltage	$V_{CC}$	Applied across P-N Terminals	0 ~ 400	Volts
	$V_D$	Applied between $V_{UP1}$ - $V_{UPC}$ , $V_{N1}$ - $V_{NC}$ , $V_{VP1}$ - $V_{VPC}$ , $V_{WP1}$ - $V_{WPC}$	$15 \pm 1.5$	Volts
Input ON Voltage	$V_{CIN(on)}$	Applied between	0 ~ 0.8	Volts
Input OFF Voltage	$V_{CIN(off)}$	$U_P$ - $V_{UPC}$ , $V_P$ - $V_{VPC}$ , $W_P$ - $V_{WPC}$ , $U_N$ · $V_N$ · $W_N$ · $B_r$ - $V_{NC}$	$4.0 \sim V_D$	Volts
PWM Input Frequency	$f_{PWM}$	Using Application Circuit	5 ~ 20	kHz
Minimum Dead Time	$t_{dead}$	Input Signal	$\geq 2.5$	$\mu s$

# PM50RSK060

FLAT-BASE TYPE  
INSULATED PACKAGE

## Inverter Part

**SATURATION VOLTAGE CHARACTERISTICS (TYPICAL)**

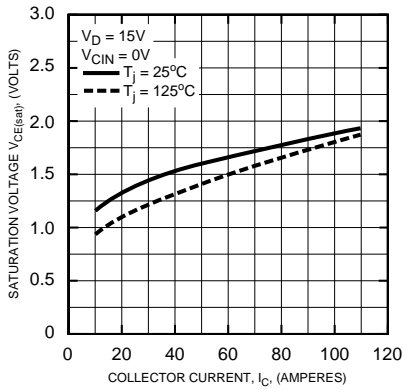

**COLLECTOR-EMITTER SATURATION VOLTAGE CHARACTERISTICS (TYPICAL)**

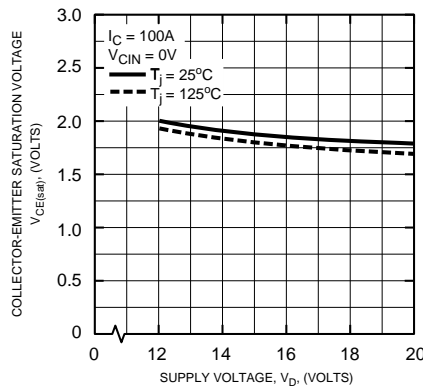

**OUTPUT CHARACTERISTICS (TYPICAL)**

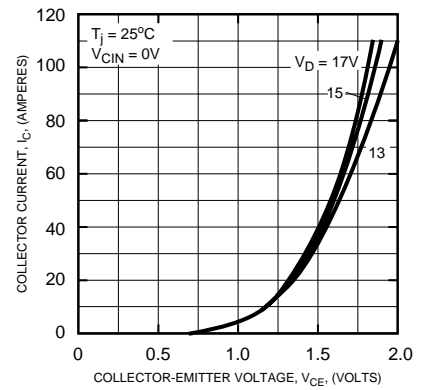

**SWITCHING TIME VS. COLLECTOR CURRENT (TYPICAL)**

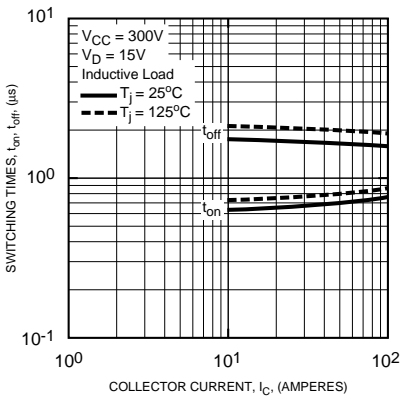

**SWITCHING TIME VS. COLLECTOR CURRENT (TYPICAL)**

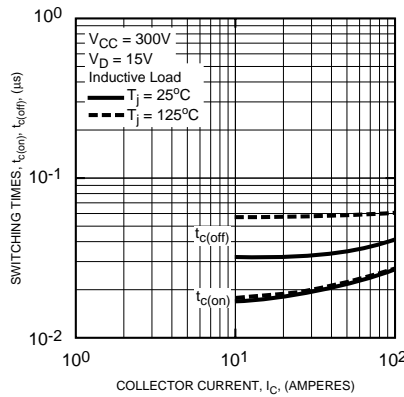

**REVERSE RECOVERY CURRENT VS. COLLECTOR CURRENT (TYPICAL)**

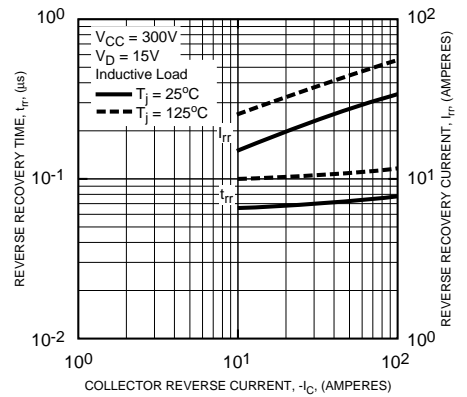

**DIODE FORWARD CHARACTERISTICS**

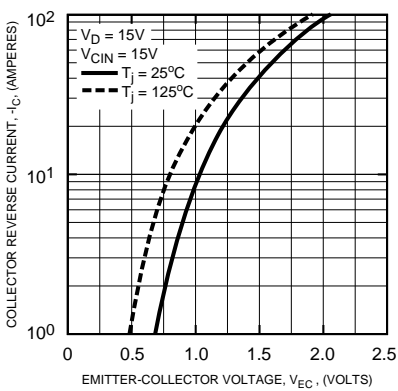

**OVER CURRENT TRIP LEVEL VS. SUPPLY VOLTAGE (TYPICAL)**

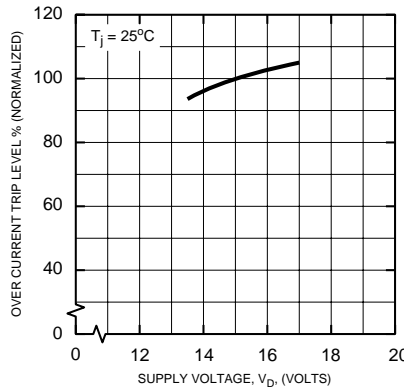

**OVER CURRENT TRIP LEVEL VS. TEMPERATURE (TYPICAL)**

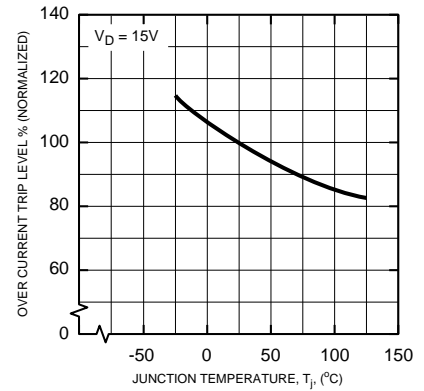

# PM50RSK060

FLAT-BASE TYPE  
INSULATED PACKAGE

## Inverter Part

**FAULT OUTPUT PULSE WIDTH VS. TEMPERATURE (TYPICAL)**

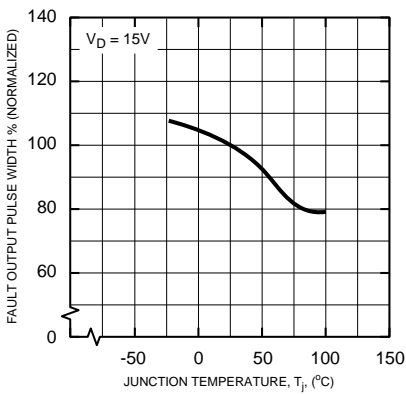

**CONTROL SUPPLY VOLTAGE TRIP-RESET LEVEL TEMPERATURE DEPENDENCY (TYPICAL)**

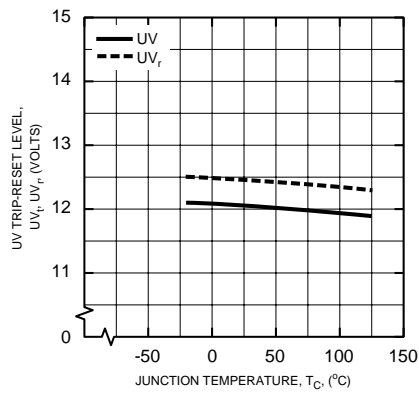

**TRANSIENT THERMAL IMPEDANCE CHARACTERISTICS (Each IGBT)**

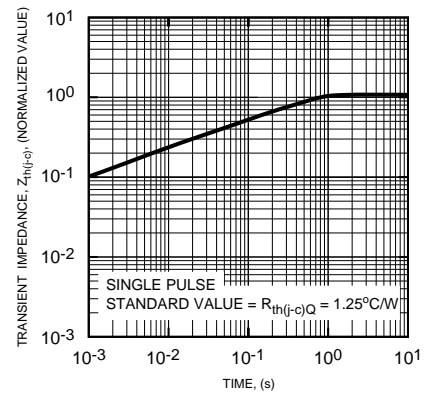

**TRANSIENT THERMAL IMPEDANCE CHARACTERISTICS (Each FWD)**

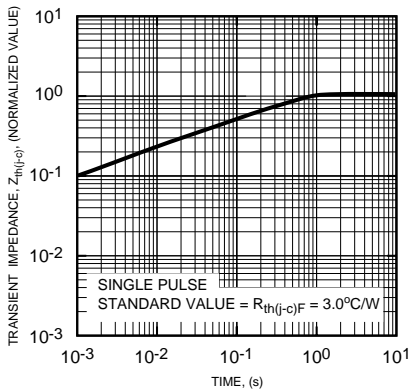

# PM50RSK060

FLAT-BASE TYPE  
INSULATED PACKAGE

## Brake Part

**SATURATION VOLTAGE CHARACTERISTICS (TYPICAL)**

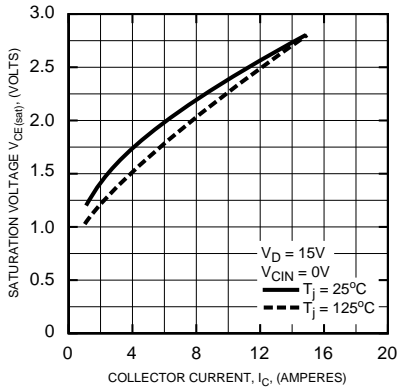

**COLLECTOR-EMITTER SATURATION VOLTAGE CHARACTERISTICS (TYPICAL)**

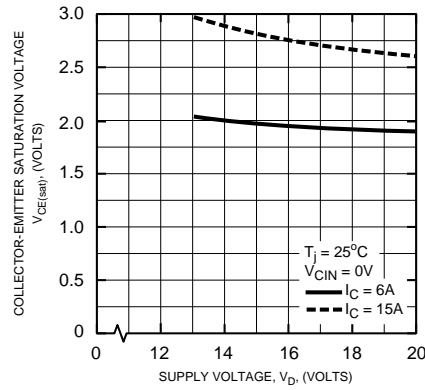

**OUTPUT CHARACTERISTICS (TYPICAL)**

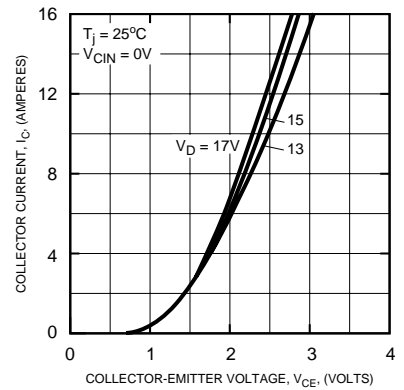

**DIODE FORWARD CHARACTERISTICS**

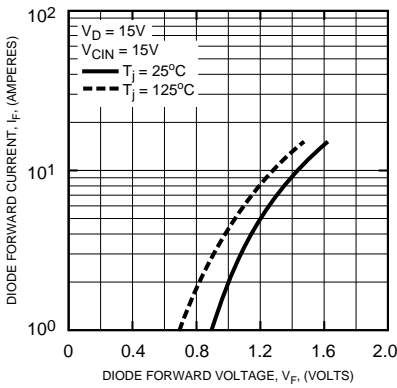

**TRANSIENT THERMAL IMPEDANCE CHARACTERISTICS (Each IGBT)**

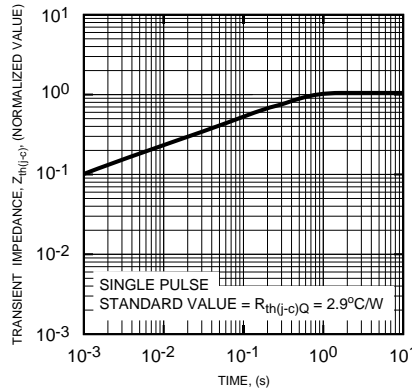

**TRANSIENT THERMAL IMPEDANCE CHARACTERISTICS (Each FWDi)**

