



Powerex, Inc., 200 Hillis Street, Youngwood, Pennsylvania 15697-1800 (412) 925-7272
 Powerex, Europe, S.A. 428 Avenue G. Durand, BP107, 72003 Le Mans, France (43) 41.14.14

INTELLIMOD™ - 2nd & 3rd Generation Intelligent Power Modules

Powerex Intellimod™ Power Modules are the most advanced power modules in the industry. Each device contains current sense IGBT chips, optimized gate drive circuitry, protection circuitry for over-current, short circuit, over temperature and under gate

voltage supply conditions. Configurations from three-phase to half-phase are available as shown in the following tables. The Second Generation products offerings will be phased out in favor of the higher performance Third Generation product offerings.

For additional specifications please refer to our Intellimod Technical Data Book for Intelligent Power Modules (Pub # 10A-200) and contact your local Powerex manufacturers' representative for Third Generation Information.

INTELLIMOD™ 2nd Generation Selector Table*

Type I _C (A) \ V _{CES} (V)	Single		Dual		Six-in-1	Seven-in-1	
	600	1200	600	1200	600	600	1200
10					PM10CMA060 (H15)		PM10RHB120 (H17)
15					PM15CMA060 (H15)		PM15RHB120 (H17)
20 (25A)					PM20CMA060 (H15)		PM25RHB120 (H17)
30					PM30CMA060 (H15)	PM30RMC060 (H16)	
50						PM50RHA060 (H18) PM50RHB060 (H17)	PM50RHA120 (H19)
75				PM75DHA120 (H20)		PM75RHA060 (H18)	
100			PM100DHA060 (H20)	PM100DHA120 (H21)			
150			PM150DHA060 (H20)	PM150DHA120 (H23)			
200			PM200DHA060 (H21)	PM200DHA120 (H22)			
300		PM300HHA120 (H24)	PM300DHA060 (H23)				
400			PM400DHA060 (H22)				
600	PM600HHA060 (H24)						

*New designs should start with the 3rd Generation Product.

INTELLIMOD™ 3rd Generation Selector Table

Type		Dual		Six-in-1		Seven-in-1	
I_C (A)	V_{CES} (V)	600	1200	600	1200	600	1200
10				PM10CSJ060 (H25)			PM10RSH120 (H30)
15				PM15CSJ060 (H25)			PM15RSH120 (H30)
20 (25A)				PM20CSJ060 (H25)			PM25RSB120 (H31)
30				PM30CSJ060 (H25)		PM30RSF060 (H26)	
50						PM50RSA060 (H33) PM50RSK060 (H27)	PM50RSA120 (H32)
75		PM75DSA120 (H20)			PM75CSA120 (H28)	PM75RSA060 (H33)	
100		PM100DSA120 (H20)		PM100CSA060 (H28)	PM100CSA120 (H29)	PM100RSA060 (H34)	
150		PM150DSA120 (H21)		PM150CSA060 (H28)		PM150RSA060 (H34)	
200	PM200DSA060 (H20)	PM200DSA120 (H23)		PM200CSA060 (H29)			
300	PM300DSA060 (H21)	PM300DSA120 (H22)					
400	PM400DSA060 (H23)						
600	PM600DSA060 (H22)						

H15

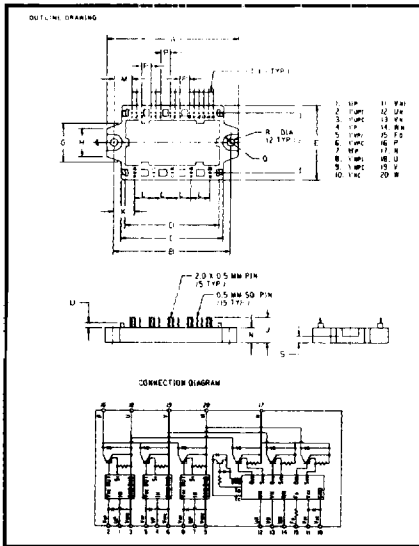

Dimension	Inches	Millimeters
A	3.86 ± 0.04	98.0 ± 1.0
B	3.42 ± 0.02	87.0 ± 0.5
C	2.99	76.0
D	2.76	70.0
E	2.2 ± 0.04	56.0 ± 1.0
F	1.77	45.0
G	1.14	29.0
H	0.83	21.0
J	0.73	18.5
K	0.61	15.5
L	0.55	14.0
M	0.521	13.24
N	0.43	11.0
P	0.28	7.12
Q	0.24 Rad.	6.0 Rad.
R	0.22 Dia.	5.5 Dia.
S	0.2	5.0
T	0.14	3.56
U	0.13	3.5

PM10CMA060, PM15CMA060,
 PM20CMA060, PM30CMA060

H16

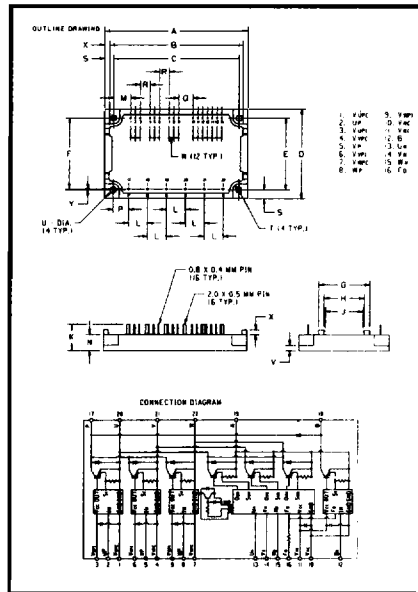

Dimension	Inches	Millimeters
A	4.17 ± 0.04	106 ± 1.0
B	3.9	99.0
C	3.66 ± 0.02	93.0 ± 0.5
D	2.64 ± 0.04	67.0 ± 1.0
E	2.12 ± 0.02	54.0 ± 0.5
F	2.11 ± 0.02	53.5 ± 0.5
G	1.50	38.0
H	1.18	30.0
J	1.1	28.0
K	0.77 ± 0.04	19.5 ± 1.0
L	0.55 ± 0.01	14.0 ± 0.25
M	0.5	12.7
N	0.47	12.0
P	0.45	11.5
Q	0.42	10.68
R	0.28	7.12
S	0.26	6.5
T	0.18 Rad.	4.5 Rad.
U	0.18 Dia.	4.5 Dia.
V	0.16 ± 0.02	4.0 ± 0.5
W	0.14	3.56
X	0.14	3.5
Y	0.02	0.5

PM30RMC060

H17

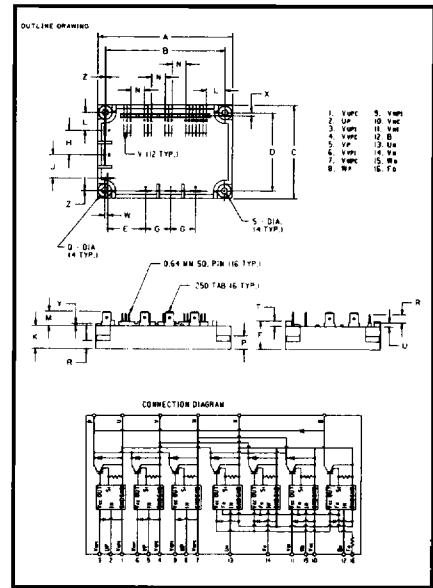

Dimension	Inches	Millimeters
A	3.96 ± 0.04	100.5 ± 1.0
B	3.48 ± 0.02	88.5 ± 0.5
C	2.76 ± 0.04	70.0 ± 1.0
D	2.30 ± 0.02	58.5 ± 0.5
E	1.191	30.25
F	0.83	21.0
G	0.73	18.5
H	0.71	18.0
J	0.69	17.5
K	0.67	17.0
L	0.541	13.75
M	0.41	10.5
N	0.4	10.16
P	0.39	10.0
Q	0.39 Dia.	10.0 Dia.
R	0.24	6.0
S	0.18 Dia.	4.5 Dia.
T	0.16	4.0
U	0.12	3.0
V	0.1	2.54
W	0.088	2.25
X	0.086	2.18
Y	0.06	1.50
Z	0.001	0.25

PM10RHB120, PM15RHB120,
 PM25RHB120, PM50RHB060

H18

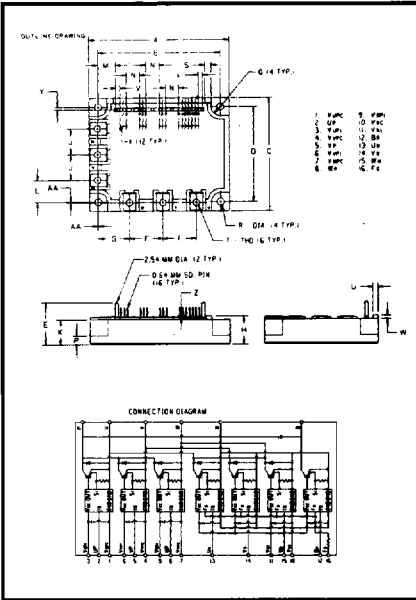

Dimension	Inches	Millimeters
A	4.29 ± 0.04	109.0 ± 1.0
B	3.74 ± 0.02	95.0 ± 0.5
C	3.46 ± 0.04	88.0 ± 1.0
D	2.91 ± 0.02	74.0 ± 0.5
E	1.28	32.6
F	1.02	26.0
G	0.94	24.0
H	0.87	22.0
J	0.79	20.0
K	0.76	19.4
L	0.67	17.0
M	0.54	13.8
N	0.40	10.16
P	0.28	7.0
Q	0.28 Rad.	7.0 Rad.
R	0.22 Dia.	5.5 Dia.
S	0.2	5.0
T	M5 Metric	M5
U	0.16	4.0
V	0.127	3.22
W	0.1	2.6
X	0.1	2.54
Y	0.08	2.0
Z	0.04	1.0
AA	0.02	0.5

PM50RHA060, PM75RHA060

H19

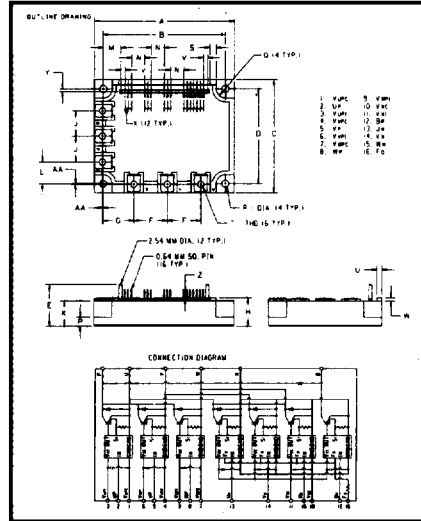

Dimension	Inches	Millimeters
A	4.37 ± 0.04	111.0 ± 1.0
B	3.74 ± 0.02	95.0 ± 0.5
C	3.5 ± 0.04	89.0 ± 1.0
D	2.91 ± 0.02	74.0 ± 0.5
E	1.24	31.6
F	1.02	26.0
G	0.94	24.0
H	0.87	22.0
J	0.79	20.0
K	0.76	19.4
L	0.67	17.0
M	0.54	13.8
N	0.4	10.16
P	0.28	7.0
Q	0.28 Rad.	7.0 Rad.
R	0.22 Rad.	5.5 Rad.
S	0.2	5.0
T	M5 Metric	M5
U	0.16	4.0
V	0.127	3.22
W	0.1	2.6
X	0.1	2.54
Y	0.08	2.0
Z	0.04	1.0
AA	0.02	0.5

PM50RHA120

H20

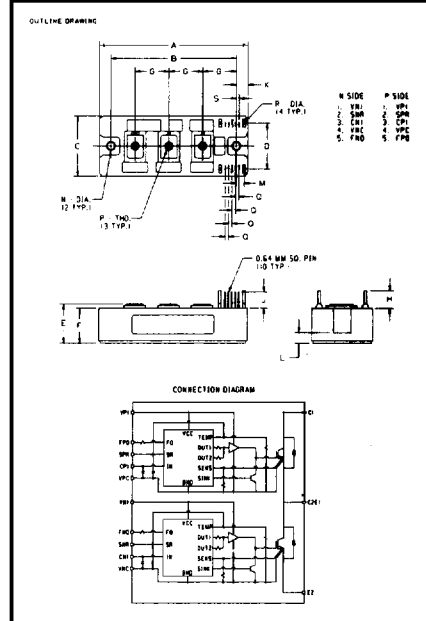

Dimension	Inches	Millimeters
A	4.33	110.0
B	3.66 ± 0.01	93.0 ± 0.25
C	1.77	45.0
D	1.34	34.0
E	1.14 +0.04/-0.02	29.0 +1.0/-0.5
F	1.02	26.0
G	0.98	25.0
H	0.51	13.0
J	0.47	12.0
K	0.33	8.5
L	0.31	8.0
M	0.23	5.84
N	0.22 Dia.	5.5 Dia.
P	M5 Metric	M5
Q	0.1	2.54
R	0.08 Dia.	2.0 Dia.
S	0.08	2.0

PM100DHA060, PM150DHA060,
 PM75DHA120, PM200DSA060,
 PM100DSA120, PM75DSA120

H21

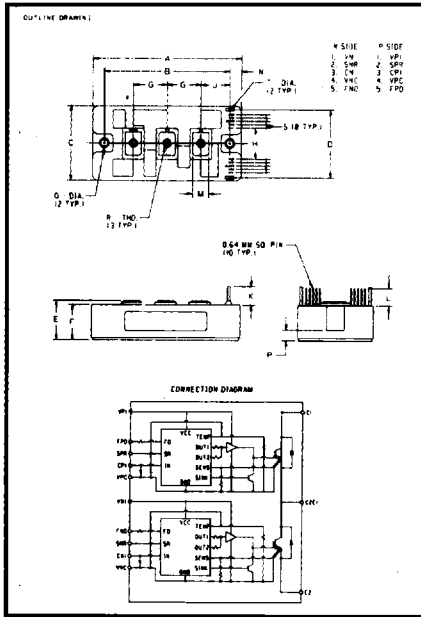

Dimension	Inches	Millimeters
A	4.33	110.0
B	3.66 ± 0.01	93.0 ± 0.25
C	2.2	56.0
D	2.01	51.0
E	1.14 +0.04/-0.02	29.0 +1.0/-0.5
F	1.02	26.0
G	0.98	25.0
H	0.9	23.0
J	0.85	21.5
K	0.55	14.0
L	0.51	13.0
M	0.47	12.0
N	0.33	8.5
P	0.31	8.0
Q	0.22 Dia.	5.5 Dia.
R	M5 Metric	M5
S	0.1	2.54
T	0.08 Dia.	2.0 Dia.

PM200DHA060, PM300DSA060,
 PM100DHA120, PM150DSA120

H22

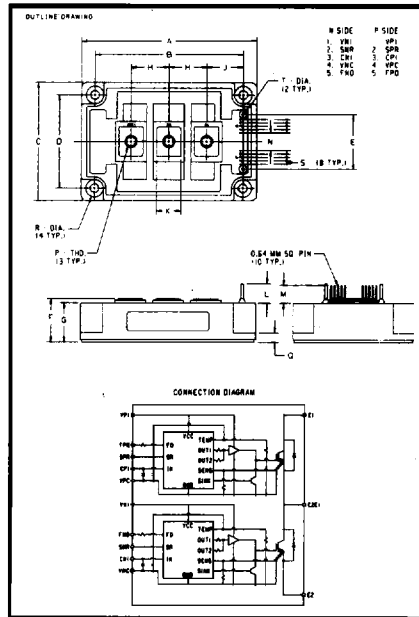

Dimension	Inches	Millimeters
A	5.12	130.0
B	4.33 ± 0.01	110.0 ± 0.25
C	3.54	90.0
D	2.76 ± 0.01	70.0 ± 0.25
E	1.61	41.0
F	1.34 +0.04/-0.02	34.0 +1.0/-0.5
G	1.22	31.0
H	1.1	28.0
J	1.06	27.0
K	0.71	18.0
L	0.57	14.5
M	0.53	13.5
N	0.51	13.0
.P	M8 Metric	M8
Q	0.28	7.0
R	0.26 Dia.	6.5 Dia.
S	0.1	2.54
T	0.08 Dia.	2.0 Dia.

PM400DHA060, PM600DSA060,
 PM200DHA120, PM300DSA120

H23

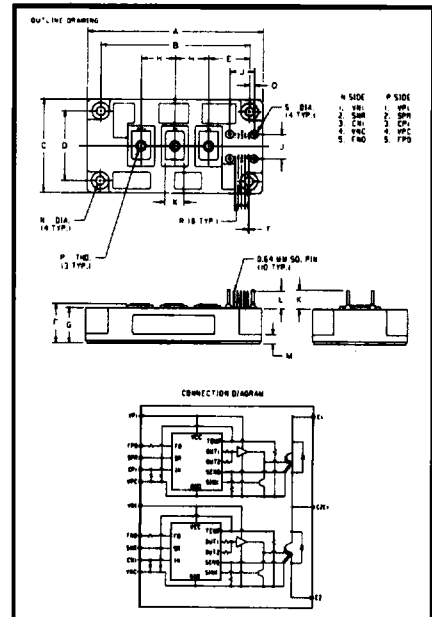

Dimension	Inches	Millimeters
A	5.12	130.0
B	4.33 ± 0.01	110.0 ± 0.25
C	2.76	70.0
D	2.05 ± 0.01	52.0 ± 0.25
E	1.18	30.0
F	1.14 +0.04/-0.02	29.0 +1.0/-0.5
G	1.02	26.0
H	0.98	25.0
J	0.71	18.0
K	0.55	14.0
L	0.51	13.0
M	0.28	7.0
N	0.26 Dia.	6.5 Dia.
P	M6 Metric	M6
Q	0.14	3.5
R	0.1	2.54
S	0.08 Dia.	2.0 Dia.
T	0.016	0.42

PM300DHA060, PM150DHA120,
 PM400DSA060, PM200DSA120

Powerex, Inc., 200 Hillis Street, Youngwood, Pennsylvania 15697-1800 (412) 925-7272
 Powerex, Europe, S.A. 428 Avenue G. Durand, BP107, 72003 Le Mans, France (43) 41.14.14

H24

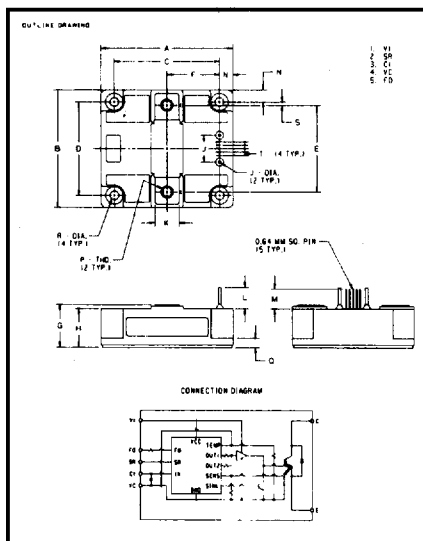

Dimension	Inches	Millimeters
A	3.86	98.0
B	3.46	88.0
C	3.15 ± 0.01	80.0 ± 0.25
D	2.76 ± 0.01	70.0 ± 0.25
E	2.56	65.0
F	1.57	40.0
G	1.34 +0.04/-0.02	34.0 +1.0/-0.5
H	1.16	29.5
J	0.79	20.0
K	0.71	18.0
L	0.63	16.0
M	0.59	15.0
N	0.35	9.0
P	M8 Metric	M8
Q	0.28	7.0
R	0.26 Dia.	6.5 Dia.
S	0.1	2.54
T	0.1	2.54
U	0.08 Dia.	2.0 Dia.

PM600HHA060, PM300HHA120

H25

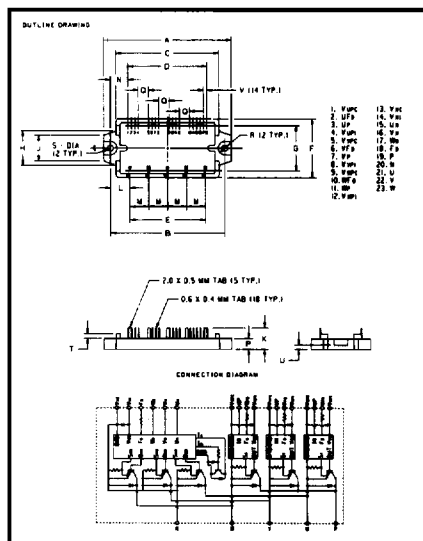

Dimension	Inches	Millimeters
A	3.72 ± 0.04	94.5 ± 1.0
B	3.33 ± 0.02	84.5 ± 0.5
C	2.99	76.0
D	2.3 ± 0.02	58.42 ± 0.5
E	2.2 ± 0.02	56.0 ± 0.5
F	1.73 ± 0.04	44.0 ± 1.0
G	1.32 ± 0.02	33.6 ± 0.5
H	1.01	25.7
J	0.75	19.0
K	0.63 ± 0.04	16.0 ± 1.0
L	0.561	14.25
M	0.55 ± 0.01	14.0 ± 0.25
N	0.513	13.04
P	0.31 ± 0.02	8.0 ± 0.5
Q	0.3	7.62
R	0.2 Rad.	5.0 Rad.
S	0.18 Dia.	4.5 Dia.
T	0.14	3.5
U	0.13 ± 0.02	3.2 ± 0.5
V	0.1 ± 0.01	2.54 ± 0.25

PM10CSJ060, PM15CSJ060,
 PM20CSJ060, PM30CSJ060

H26

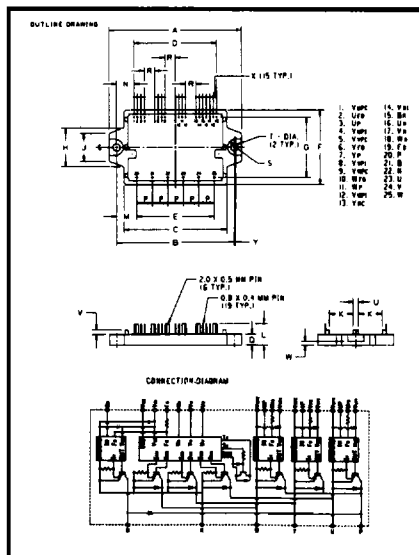

Dimension	Inches	Millimeters
A	3.86 ± 0.04	98.0 ± 1.0
B	3.42 ± 0.02	87.0 ± 0.5
C	2.99	76.0
D	2.4 ± 0.03	60.96 ± 0.8
E	2.25 ± 0.03	57.15 ± 0.8
F	2.2 ± 0.04	56.0 ± 1.0
G	1.77 ± 0.3	45.0 ± 0.8
H	1.14	29.0
J	0.83	21.0
K	0.69	17.5
L	0.63 ± 0.04	16.0 ± 1.0
M	0.588	14.925
N	0.512	13.02
P	0.45 ± 0.012	11.43 ± 0.3
Q	0.31 ± 0.02	8.0 ± 0.5
R	0.3	7.62
S	0.24 Rad.	6.0 Rad.
T	0.22 Dia.	5.5 Dia.
U	0.16	4.0
V	0.14	3.5
W	0.12 ± 0.02	3.0 ± 0.5
X	0.1 ± 0.012	2.54 ± 0.3
Y	0.04	1.0

PM30RSF060

H27

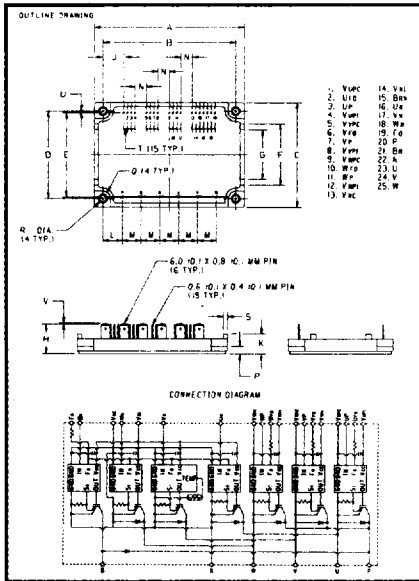

Dimension	Inches	Millimeters
A	3.96 ± 0.04	100.5 ± 1.0
B	3.48 ± 0.02	88.5 ± 0.5
C	2.76 ± 0.04	70.0 ± 1.0
D	2.30 ± 0.02	58.5 ± 0.5
E	2.22 ± 0.02	56.5 ± 0.5
F	1.61	41.0
G	1.30	33.0
H	0.79 ± 0.04	20.0 ± 1.0
J	0.542	13.77
K	0.53	13.5
L	0.51	13.0
M	0.49 ± 0.01	12.5 ± 0.25
N	0.3 ± 0.01	7.62 ± 0.25
P	0.2	5.0
Q	0.2 Rad.	5. Rad.
R	0.18 Dia.	4.5 Dia.
S	0.108	2.75
T	0.1 ± 0.01	2.54 ± 0.25
U	0.03	0.75
V	0.02	0.5

PM50RSK060

H28

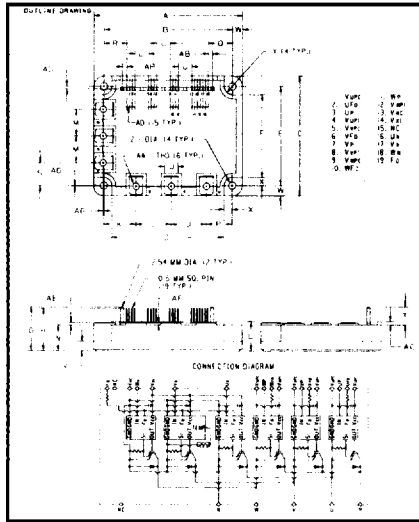

Dimension	Inches	Millimeters
A	4.33 ± 0.04	110.0 ± 1.0
B	3.74 ± 0.02	95.0 ± 0.5
C	3.50 ± 0.04	89.0 ± 1.0
D	3.27	83.0
E	2.91 ± 0.02	74.0 ± 0.5
F	2.44	62.0
G	1.28	32.6
H	1.24	31.6
J	1.02	26.0
K	0.94	24.0
L	0.87 +0.06/-0.0	22.0 +1.5/-0.0
M	0.79	20.0
N	0.76	19.4
P	0.75	19.0
Q	0.708	17.98
R	0.670	17.02
S	0.67	17.0
T	0.52	13.2
U	0.39	10.0
V	0.32	8.0
W	0.3	7.5
X	0.24	6.0
Y	0.24 Rad.	6.0 Rad.
Z	0.22 Dia.	5.5 Dia.
AA	M5 Metric	M5
AB	0.127	3.22
AC	0.1	2.6
AD	0.08	2.0
AE	0.07	1.8
AF	0.06	1.6
AG	0.02	0.5

PM100CSA060, PM150CSA060,
 PM75CSA120

H29

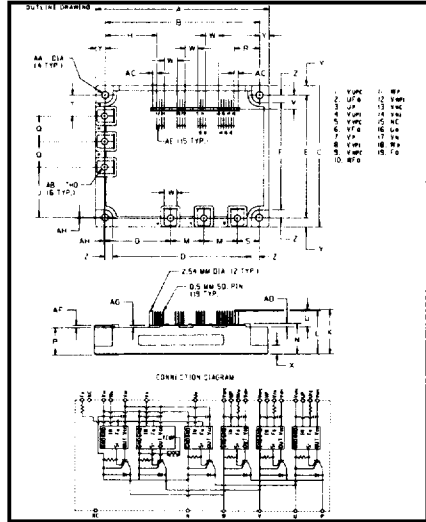

Dimension	Inches	Millimeters
A	5.31 ± 0.04	135.0 ± 1.0
B	4.74 ± 0.02	120.5 ± 0.5
C	4.33 ± 0.04	110.0 ± 1.0
D	4.27	108.5
E	3.76 ± 0.02	95.5 ± 0.5
F	3.29	83.5
G	2.01	51.0
H	1.602	40.68
J	1.54	39.0
K	1.37	34.7
L	1.33	33.7
M	1.02	26.0
N	0.95 +0.06/-0.0	24.1 +1.5/-0.0
P	0.85	21.5
Q	0.79	20.0
R	0.78	19.82
S	0.69	17.5
T	0.65	16.5
U	0.52	13.2
V	0.43	11.0
W	0.39	10.0
X	0.31	8.0
Y	0.285	7.5
Z	0.24	6.0
AA	0.22 Dia.	5.5 Dia.
AB	M5 Metric	M5
AC	0.128	3.22
AD	0.1	2.6
AE	0.08	2.0
AF	0.07	1.8
AG	0.06	1.6
AH	0.02	0.5

PM200CSA060, PM100CSA120

H30

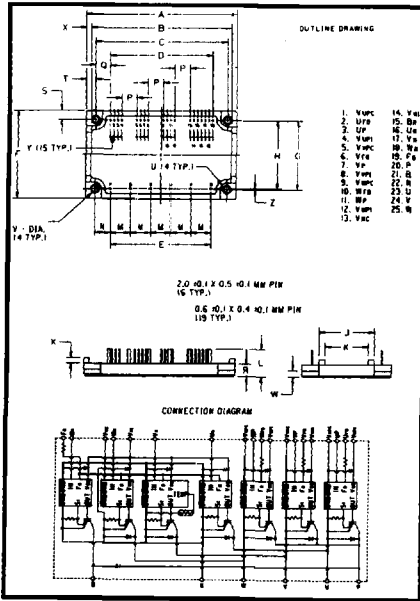

H31

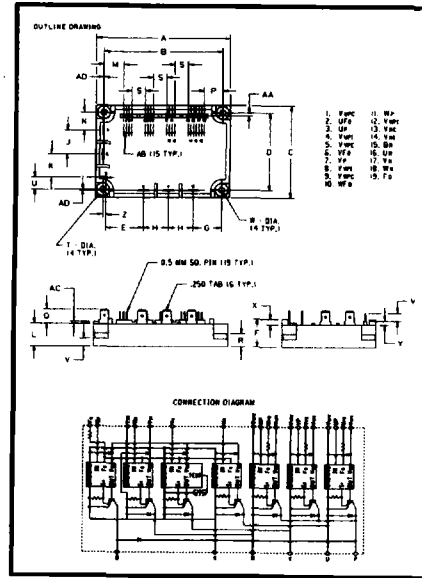

H32

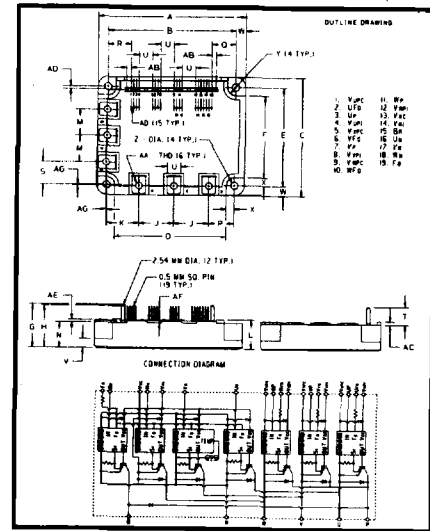

Dimension	Inches	Millimeters
A	3.98 ± 0.04	101.0 ± 1.0
B	3.70	96.0
C	3.48 ± 0.03	88.5 ± 0.8
D	2.70 ± 0.03	68.58 ± 0.8
E	2.66 ± 0.02	67.5 ± 0.5
F	2.36 ± 0.04	60.0 ± 1.0
G	1.85 ± 0.02	47.0 ± 0.5
H	1.83 ± 0.03	46.5 ± 0.8
J	1.46	37.0
K	1.14	29.0
L	0.71 ± 0.04	18.0 ± 1.0
M	0.53 ± 0.01	13.5 ± 0.3
N	0.41	10.5
P	0.4	10.16
Q	0.392	9.96
R	0.31	8.0
S	0.26	6.5
T	0.246	6.25
U	0.18 Dia.	4.5 Dia.
V	0.18 Dia.	4.5 Dia.
W	0.16 ± 0.02	4.0 ± 0.5
X	0.14	3.5
Y	0.100 ± 0.01	2.54 ± 0.25
Z	0.02	0.5

Dimension	Inches	Millimeters
A	3.96 ± 0.04	100.5 ± 1.0
B	3.48 ± 0.02	88.5 ± 0.5
C	2.76 ± 0.04	70.0 ± 1.0
D	2.3 ± 0.02	58.5 ± 0.5
E	1.91 ± 0.02	30.25 ± 0.5
F	0.83	21.0
G	0.75	19.0
H	0.73	18.5
J	0.71	18.0
K	0.69	17.5
L	0.67	17.0
M	0.581	14.76
N	0.541	13.75
P	0.541	13.74
Q	0.41	10.5
R	0.39	10.0
S	0.394 ± 0.01	10.0 ± 0.25
T	0.39 Dia.	10.0 Dia.
U	0.364	9.25
V	0.24	6.0
W	0.18 Dia.	4.5 Dia.
X	0.16	4.0
Y	0.12	3.0
Z	0.088 ± 0.02	2.25 ± 0.5
AA	0.086 ± 0.02	2.18 ± 0.5
AB	0.079 ± 0.01	2.0 ± 0.25
AC	0.06	1.5
AD	0.01	0.25

Dimension	Inches	Millimeters
A	4.33 ± 0.04	110.0 ± 1.0
B	3.74 ± 0.02	95.0 ± 0.5
C	3.5 ± 0.04	89.0 ± 1.0
D	3.27	83.0
E	2.91 ± 0.02	74.0 ± 0.5
F	2.44	62.0
G	1.28	32.6
H	1.24	31.6
J	1.02	26.0
K	0.94	24.0
L	0.87 +0.06/-0.0	22.0 +1.5/-0.0
M	0.79	20.0
N	0.76	19.4
P	0.75	19.0
Q	0.708	17.98
R	0.67	17.02
S	0.67	17.0
T	0.52	13.2
U	0.39	10.0
V	0.31	8.0
W	0.3	7.5
X	0.24	6.0
Y	0.24 Rad.	6.0 Rad.
Z	0.22 Dia.	5.5 Dia.
AA	M5 Metric	M5
AB	0.127	3.22
AC	0.1	2.6
AD	0.08	2.0
AE	0.07	1.8
AF	0.06	1.6
AG	0.02	0.05

PM25RSB120

PM10RSH120, PM15RSH120

PM50RSA120

H33

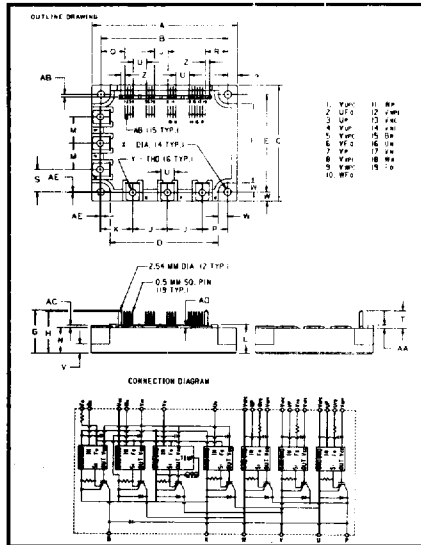

Dimension	Inches	Millimeters
A	4.29 ± 0.04	109.0 ± 1.0
B	3.74 ± 0.02	95.0 ± 0.5
C	3.46 ± 0.04	88.0 ± 1.0
D	3.19	81.0
E	2.91 ± 0.02	74.0 ± 0.5
F	2.36	60.0
G	1.28	32.6
H	1.24	31.6
J	1.02	26.0
K	0.94	24.0
L	0.87 +0.06/-0.0	22.0 +1.5/-0.0
M	0.79	20.0
N	0.76	19.4
P	0.75	19.0
Q	0.708	17.98
R	0.67	17.02
S	0.67	17.0
T	0.52	13.2
U	0.39	10.0
V	0.31	8.0
W	0.28	7.0
X	0.22 Dia.	5.5 Dia.
Y	Metric M5	M5
Z	0.127	3.22
AA	0.1	2.6
AB	0.08	2.0
AC	0.07	1.8
AD	0.06	1.6
AE	0.02	0.5

PM50RSA060, PM75RSA060

H34

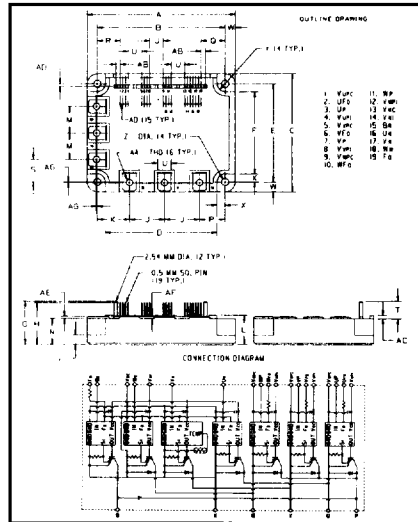

Dimension	Inches	Millimeters
A	4.33 ± 0.04	110.0 ± 1.0
B	3.74 ± 0.02	95.0 ± 0.5
C	3.5 ± 0.04	89.0 ± 1.0
D	3.27	83.0
E	2.91 ± 0.02	74.0 ± 0.5
F	2.44	62.0
G	1.28	32.6
H	1.24	31.6
J	1.02	26.0
K	0.94	24.0
L	0.87 +0.06/-0.0	22.0 +1.5/-0.0
M	0.79	20.0
N	0.76	19.4
P	0.75	19.0
Q	0.708	17.98
R	0.67	17.02
S	0.67	17.0
T	0.52	13.2
U	0.39	10.0
V	0.32	8.0
W	0.3	7.5
X	0.24	6.0
Y	0.24 Rad.	6.0 Rad.
Z	0.22 Dia.	5.5 Dia.
AA	Metric M5	M5
AB	0.127	3.22
AC	0.1	2.6
AD	0.08	2.0
AE	0.07	1.8
AF	0.06	1.6
AG	0.02	0.5

PM100RSA060, PM150RSA060