

# THYRISTOR MODULE

## PK(PD,PE,KK)55HB



UL;E76102 (M)

Power Thyristor/Diode Module **PK55HB** series are designed for various rectifier circuits and power controls. For your circuit application, following internal connections and wide voltage ratings up to 1,600V are available, and electrically isolated mounting base make your mechanical design easy.

- $I_{T(AV)}$  55A,  $I_{T(RMS)}$  86A,  $I_{TSM}$  1100A
- $di/dt$  150 A/ $\mu$ s
- $dv/dt$  500V/ $\mu$ s

### (Applications)

Various rectifiers  
AC/DC motor drives  
Heater controls  
Light dimmers  
Static switches

### Internal Configurations

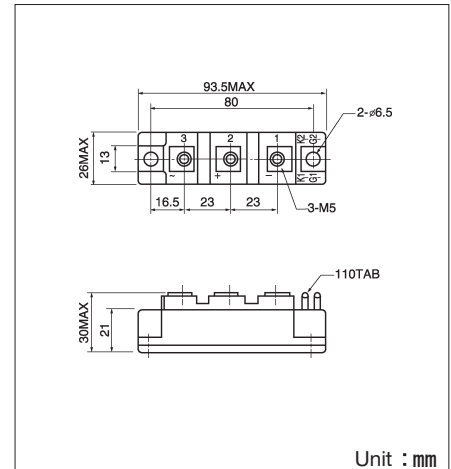
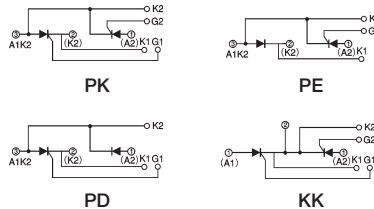

### Maximum Ratings

Symbol	Item	Ratings				Unit
		PK55HB120 KK55HB120	PD55HB120 PE55HB120	PK55HB160 KK55HB160	PD55HB160 PE55HB160	
$V_{RRM}$	*Repetitive Peak Reverse Voltage	1200		1600		V
$V_{RSM}$	*Non-Repetitive Peak Reverse Voltage	1350		1700		V
$V_{DRM}$	Repetitive Peak Off-State Voltage	1200		1600		V
Symbol	Item	Conditions		Ratings	Unit	
$I_{T(AV)}$	*Average On-State Current	Single phase, half wave, 180° conduction, $T_c : 85^\circ\text{C}$		55	A	
$I_{T(RMS)}$	*R.M.S. On-State Current	Single phase, half wave, 180° conduction, $T_c : 85^\circ\text{C}$		86	A	
$I_{TSM}$	*Surge On-State Current	$1/2$ cycle, 50Hz/60Hz, peak Value, non-repetitive		1000/1100	A	
$I^2t$	* $I^2t$	Value for one cycle of surge current		5000	A <sup>2</sup> S	
$P_{GM}$	Peak Gate Power Dissipation			10	W	
$P_{G(AV)}$	Average Gate Power Dissipation			3	W	
$I_{FGM}$	Peak Gate Current			3	A	
$V_{FGM}$	Peak Gate Voltage (Forward)			10	V	
$V_{RGM}$	Peak Gate Voltage (Reverse)			5	V	
$di/dt$	Critical Rate of Rise of On-State Current	$I_G=100\text{mA}$ , $T_j=25^\circ\text{C}$ , $V_D=1/2V_{DRM}$ , $dI_G/dt=0.1\text{A}/\mu\text{s}$		150	A/ $\mu\text{s}$	
$V_{ISO}$	*Isolation Breakdown Voltage (R.M.S.)	A.C.1minute		2500	V	
$T_j$	*Operating Junction Temperature			-40~+125	$^\circ\text{C}$	
$T_{stg}$	*Storage Temperature			-40~+125	$^\circ\text{C}$	
	Mounting Torque	Mounting (M6)	Recommended Value 2.5~3.9 (25~40)	4.7 (48)	N·m (kgf·cm)	
		Terminal (M5)	Recommended Value 1.5~2.5 (15~25)	2.7 (28)		
	Mass			170	g	

### Electrical Characteristics

Symbol	Item	Conditions	Ratings	Unit
$I_{DRM}$	Repetitive Peak Off-State Current, max.	at $V_{DRM}$ , single phase, half wave, $T_j=125^\circ\text{C}$	10	mA
$I_{RRM}$	*Repetitive Peak Reverse Current, max.	at $V_{DRM}$ , single phase, half wave, $T_j=125^\circ\text{C}$	10	mA
$V_{TM}$	*Peak On-State Voltage, max.	On-State Current 165A, $T_j=125^\circ\text{C}$ Inst. measurement	1.50	V
$I_{GT}/V_{GT}$	Gate Trigger Current/Voltage, max.	$T_j=25^\circ\text{C}$ , $I_T=1\text{A}$ , $V_D=6\text{V}$	100/2	mA/V
$V_{GD}$	Non-Trigger Gate, Voltage, min.	$T_j=125^\circ\text{C}$ , $V_D=1/2V_{DRM}$	0.25	V
$t_{gt}$	Turn On Time, max.	$I_T=55\text{A}$ , $I_G=100\text{mA}$ , $T_j=25^\circ\text{C}$ , $V_D=1/2V_{DRM}$ , $dI_G/dt=0.1\text{A}/\mu\text{s}$	10	$\mu\text{s}$
$dv/dt$	Critical Rate of Rise of Off-State Voltage, min.	$T_j=125^\circ\text{C}$ , $V_D=2/3V_{DRM}$ , Exponential wave.	500	V/ $\mu\text{s}$
$I_H$	Holding Current, typ.	$T_j=25^\circ\text{C}$	50	mA
$I_L$	Latching Current, typ.	$T_j=25^\circ\text{C}$	100	mA
$R_{th(j-c)}$	*Thermal Impedance, max.	Junction to case	0.50	$^\circ\text{C}/\text{W}$

\*mark : Thyristor and Diode part. No mark : Thyristor part

### Gate Characteristics

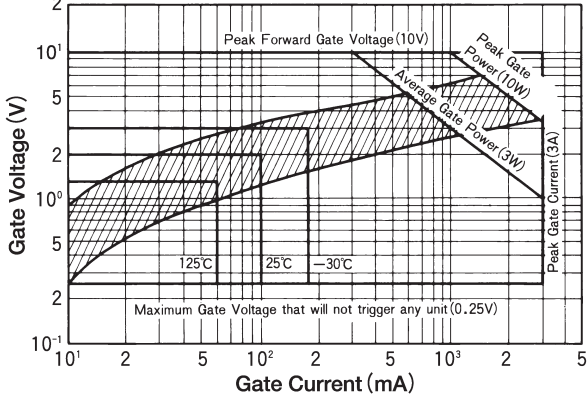

### On-State Voltage max

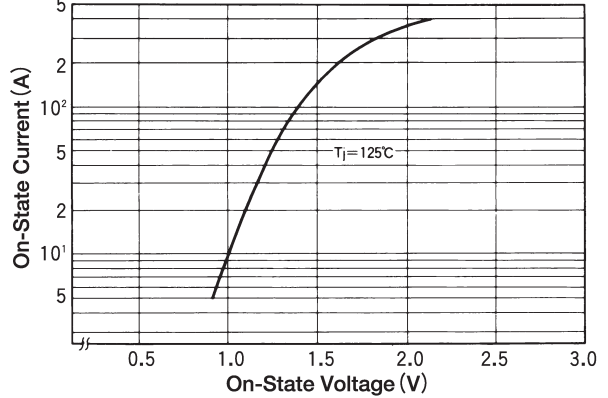

### Average On-State Current Vs Power Dissipation (Single phase half wave)

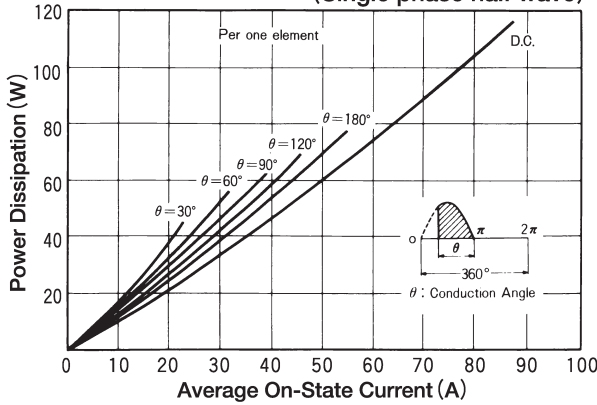

### Average On-State Current Vs Maximum Allowable Case Temperature (Single phase half wave)

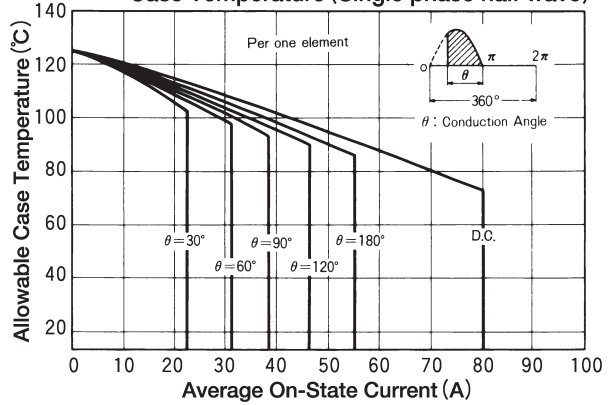

### Surge On-State Current Rating (Non-Repetitive)

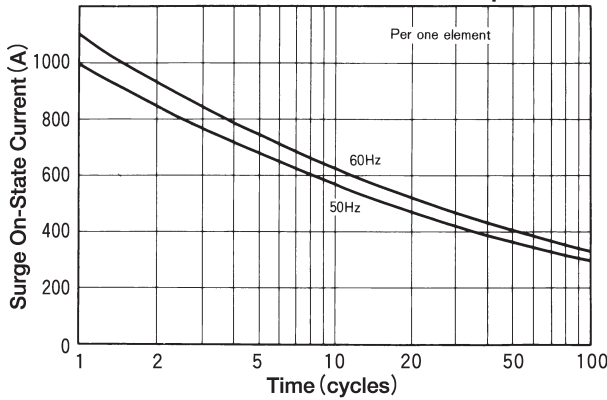

### Transient Thermal Impedance

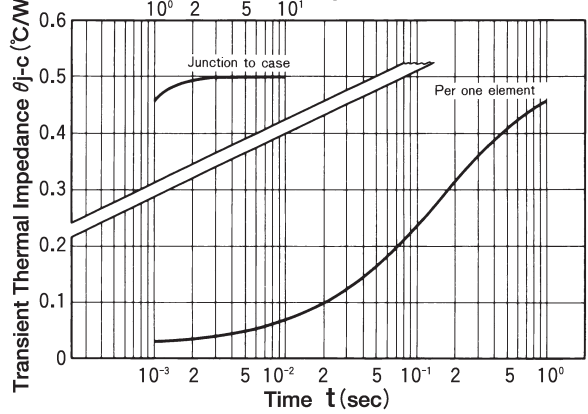

### Output Current W1; Bidirectional connection

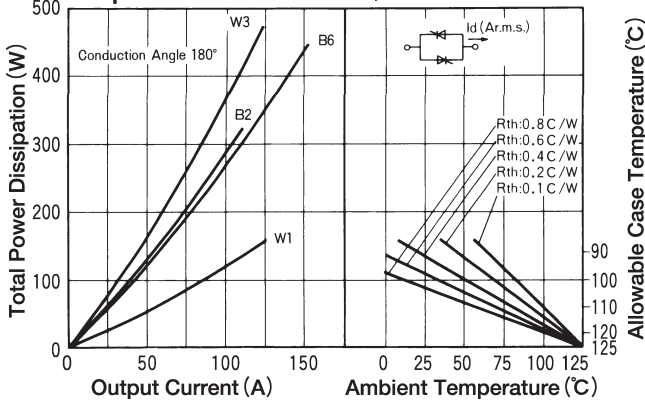

### B2; Two Pulse bridge connection

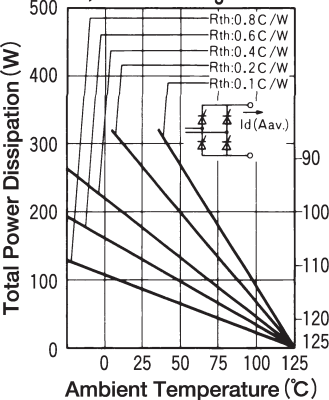

### B6; Six pulse bridge connection W3; Three phase bidirectional connection

