

MOSFET MODULE Single 560A/150V

PHM5601

OUTLINE DRAWING

FEATURES

- * Trench Gate MOS FET Module
- * Super Low Rds(ON) 2 milliohms (@560A)
- * With Fast Recovery Source-Drain Diode

TYPICAL APPLICATIONS

- * Chopper Control For FORKLIFTS

Circuit

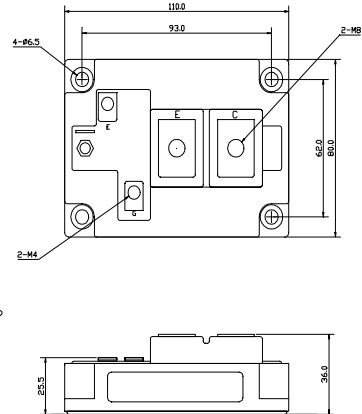
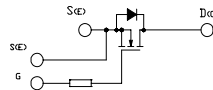

Approximate Weight : 650g

MAXMUM RATINGS

Ratings		Symbol	PHM5601		Unit
Drain-Source Voltage ($V_{GS}=0V$)		V_{DSS}	150		V
Gate - Source Voltage		V_{GSS}	+/- 20		V
Continuous Drain Current	Duty=50%	I_D	560 ($T_C=25^\circ C$)		A
	D.C.		440 ($T_C=25^\circ C$)		
Pulsed Drain Current		I_{DM}	1,120 ($T_C=25^\circ C$)		A
Total Power Dissipation		P_D	1,780 ($T_C=25^\circ C$)		W
Operating Junction Temperature Range		T_{jw}	-40 to +150		$^\circ C$
Storage Temperature Range		T_{stg}	-40 to +125		$^\circ C$
Isolation Voltage (Terminals to Base AC, 1 min.)		V_{ISO}	2,500		V
Mounting Torque	Module Base to Heatsink	F_{TOR}	3.0		N•m
	Gate Terminals		M4	1.4	
	Bus Bar to Main Terminals		M8	10.5	

ELECTRICAL CHARACTERISTICS (@ $T_C=25^\circ C$ unless otherwise noted)

Characteristic	Symbol	Test Condition	Min.	Typ.	Max.	Unit
Zero Gate Voltage Drain Current	I_{DSS}	$V_{DS}=V_{DSS}, V_{GS}=0V$	-	-	3.2	mA
Gate-Source Leakage Current	I_{GSS}	$V_{GS}=\pm 20V, V_{DS}=0V$	-	-	3.2	μA
Gate-Source Threshold Voltage	$V_{GS(th)}$	$V_{DS}=V_{GS}, I_D=16mA$	1.0	2.0	3.2	V
Static Drain-Source On-Resistance	$r_{DS(on)}$	$V_{GS}=10V, I_D=560A$	-	1.6	2.0	m-ohm
Drain-Source On-Voltage	$V_{DS(on)}$	$V_{GS}=10V, I_D=560A$	-	1.0	1.2	V
Forward Transconductance	g_{fs}	$V_{DS}=15V, I_D=560A$	-	-	-	S
Input Capacitance	C_{ies}	$V_{DS}=10V, V_{GS}=0V, f=1MHz$	-	110	-	nF
Output Capacitance	C_{oss}		-	13	-	nF
Reverse Transfer Capacitance	C_{rss}		-	13	-	nF
Rise Time	t_r	$V_{DD}=80V$	-	400	-	ns
Turn-On Delay Time	$t_{d(on)}$	$I_D=280A$	-	380	-	
Fall Time	t_f	$V_{GS}=-5V, +10V$	-	170	-	
Turn-Off Delay Time	$t_{d(off)}$	$R_G=1.2\ ohm$	-	1,100	-	

FREE WHEELING DIODES RATINGS & CHARACTERISTICS ($T_C=25^\circ C$)

Characteristic	Symbol	Test Condition	Min.	Typ.	Max.	Unit
Continuous Source Current	I_S	Duty=50%	-	-	560	A
		D.C. (Terminal Temperature=80 $^\circ C$)	-	-	450	
Pulsed Source Current	I_{SM}	-	-	-	1,120	A
Diode Forward Voltage	V_{SD}	$I_S=560A$	-	1.6	2.0	V
Reverse Recovery Time	t_{rr}	$I_S=560A, -dis/dt=1,100A/\mu s$	-	130	-	ns

THERMAL CHARACTERISTICS

Characteristic	Symbol	Test Condition	Min.	Typ.	Max.	Unit
Thermal Resistance, Junction to Case	$R_{th(j-c)}$	-	-	-	0.07	$^\circ C/W$
Thermal Resistance, Case to Heatsink	$R_{th(c-h)}$	Mounting surface flat, smooth, and greased	-	-	0.035	

PHM5601 OUTLINE DRAWING (Dimensions in mm)

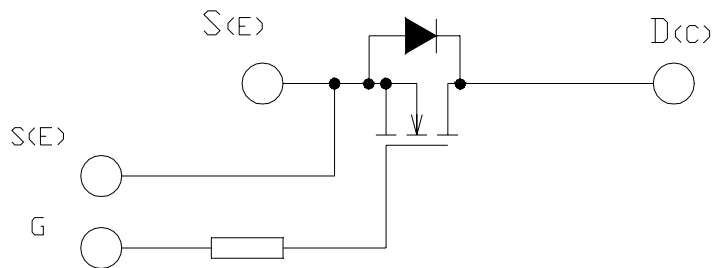
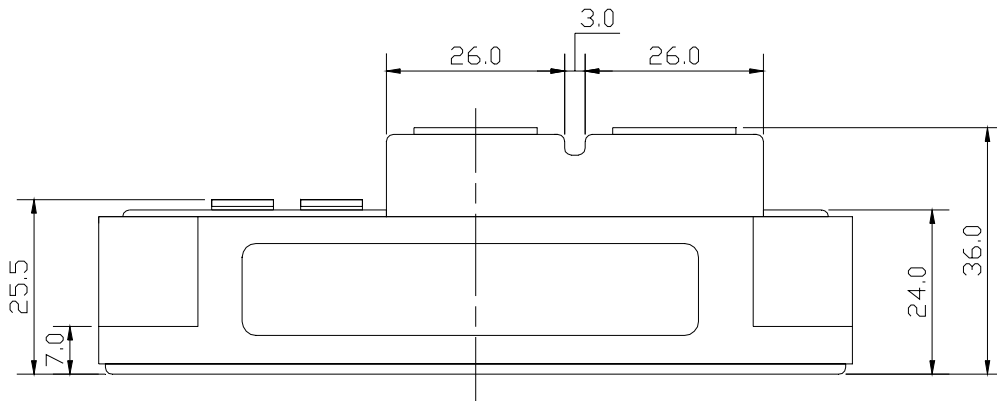
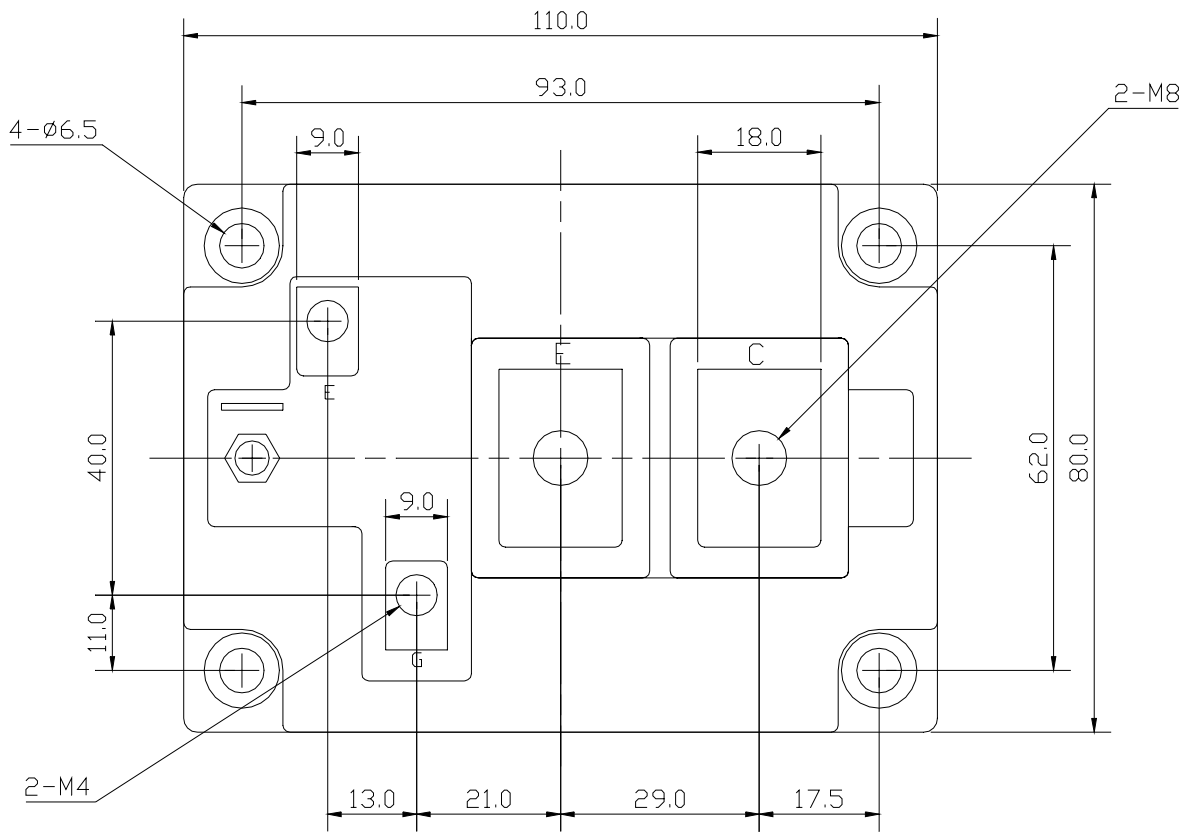

Fig.1- Output Characteristics (Typical)

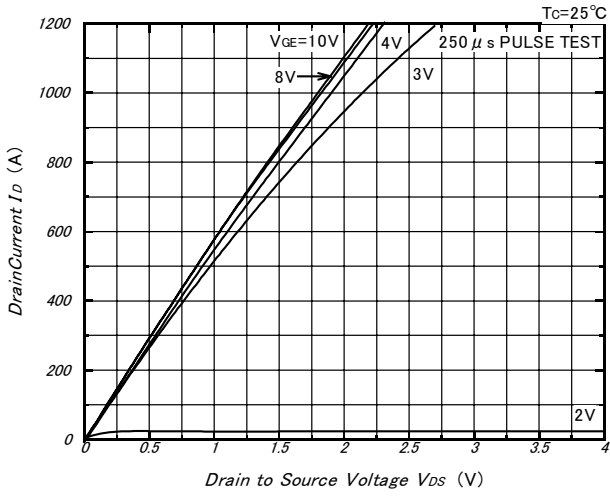

Fig.2- Drain to Source On Voltage vs. Gate to Source Voltage (Typical)

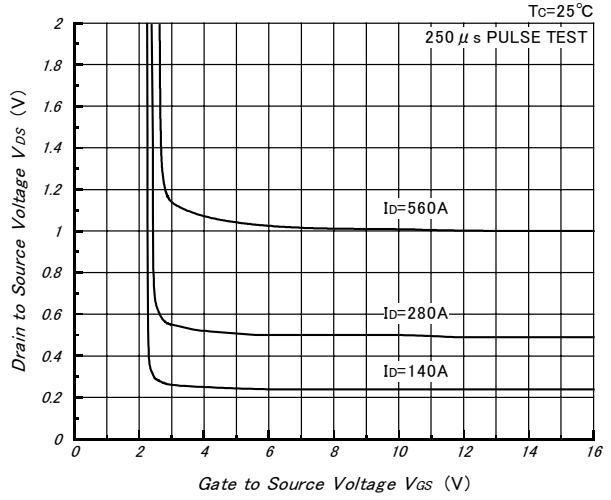

Fig.3- Drain to Source On Voltage vs. Junction Temperature (Typical)

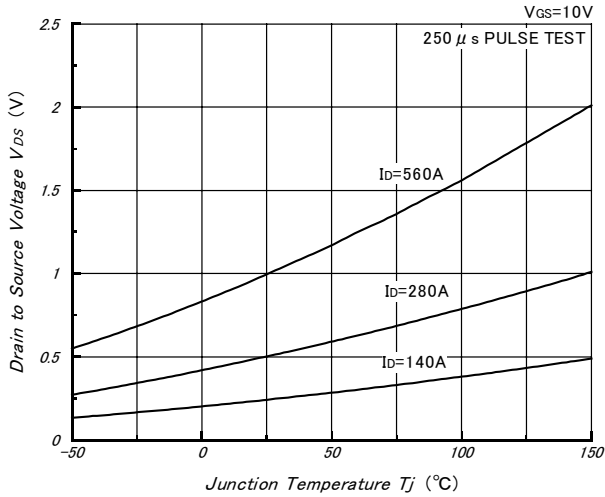

Fig.4- Capacitance vs. Drain to Source Voltage (Typical)

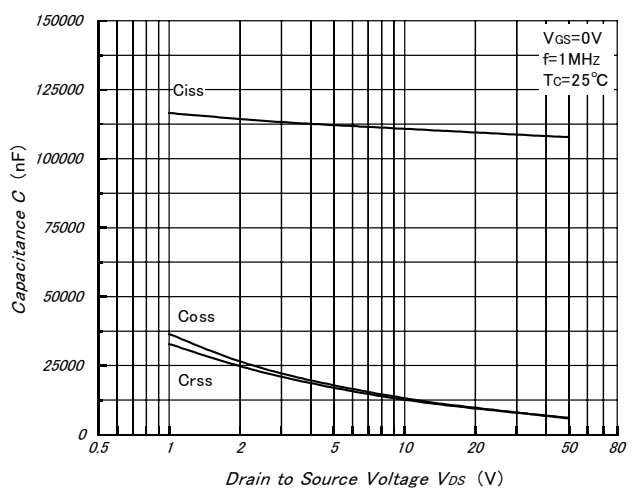

Fig.5- Gate Charge vs. Gate to Source Voltage (Typical)

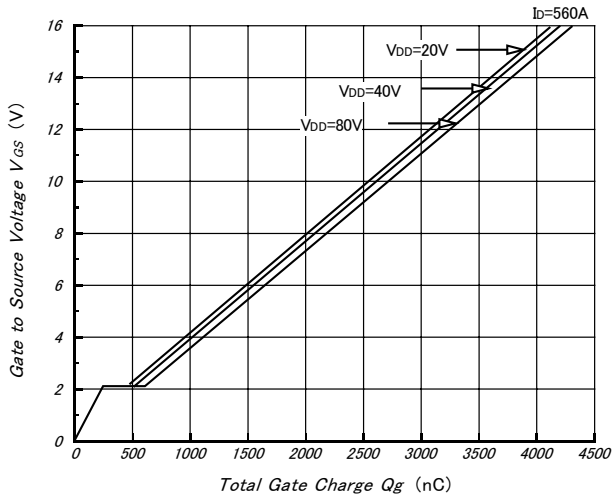

Fig.6- Series Gate Impedance vs. Switching Time (Typical)

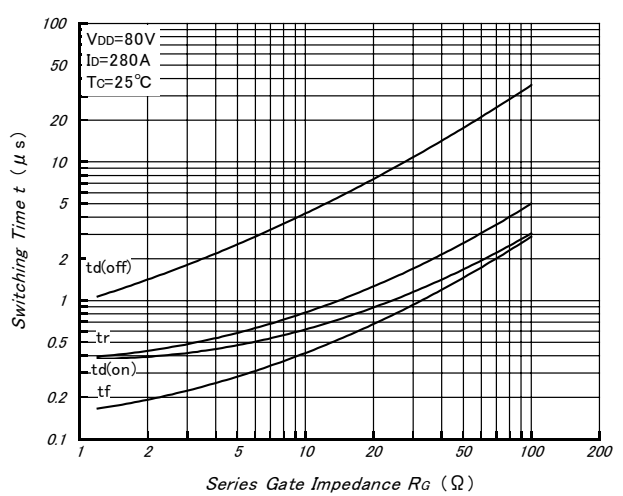

Fig.7- Drain Current vs. Switching Time (Typical)

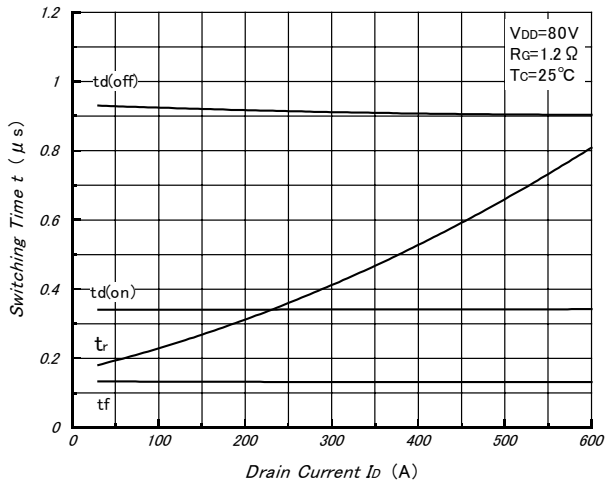

Fig.8- Source to Drain Diode Forward Characteristics (Typical)

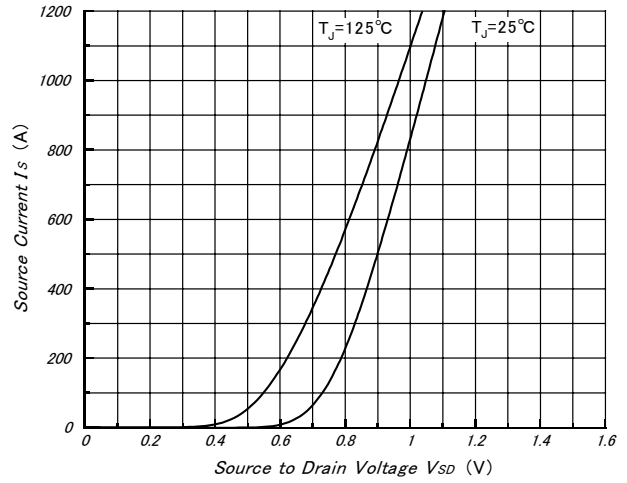

Fig.9- Reverse Recovery Characteristics (Typical)

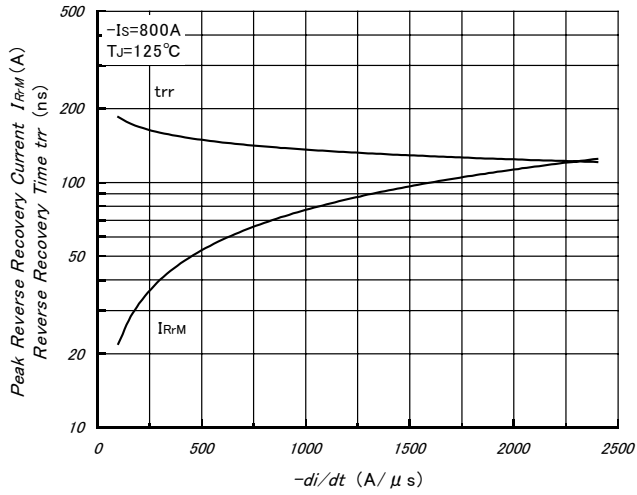

Fig.10- Maximum Transient Thermal Impedance

