

THYRISTOR MODULE

PDT2008 PDH2008

200A / 800V

FEATURES

- * Isolated Base
- * Dual Thyristors or Thyristor and Diode Cascaded Circuit
- * High Surge Capability
- * UL Recognized, File No. E187184

TYPICAL APPLICATIONS

- * AC phase control

OUTLINE DRAWING

PDT

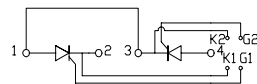

PDH

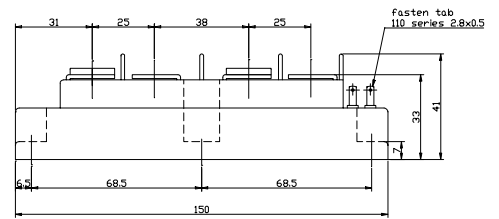
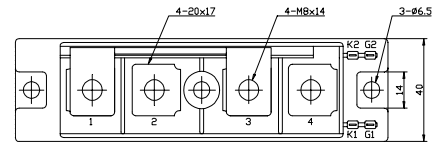
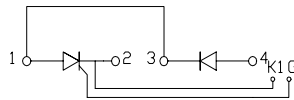

Maximum Ratings

Approx Net Weight:480g

Parameter	Symbol	Grade	Unit
		PDT/PDH2008	
Repetitive Peak Off-State Voltage	V_{DRM}	800	V
Non Repetitive Peak Off-State Voltage	V_{DSM}	960	
Repetitive Peak Reverse Voltage	V_{RRM}	800	V
Non Repetitive Peak Reverse Voltage	V_{RSM}	960	

Parameter	Symbol	Conditions	Max Rated Value	Unit	
Average Rectified Output Current *1	$I_{O(AV)}$	50Hz Half Sine Wave condition $T_c=65^\circ C$	200	A	
RMS On-State Current	$I_{T(RMS)}$		314	A	
Surge Forward Current	I_{FSM}	50 Hz Half Sine Wave, 1cycle Non-Repetitive	4000	A	
I Squared t	I^2t	2msec to 10msec	80000	A^2s	
Critical Rate of Turned-On Current	di/dt	$V_D=2/3V_{DRM}$, $I_{TM}=2 \cdot I_o$, $T_j=125^\circ C$ $I_G=300mA$, $di/dt=0.2A/\mu s$	100	$A/\mu s$	
Peak Gate Power	P_{GM}		5	W	
Average Gate Power	$P_{G(AV)}$		1	W	
Peak Gate Current	I_{GM}		2	A	
Peak Gate Voltage	V_{GM}		10	V	
Peak Gate Reverse Voltage	V_{RGM}		5	V	
Operating Junction Temperature Range	T_{jw}		-40 to +125	$^\circ C$	
Storage Temperature Range	T_{stg}		-40 to +125	$^\circ C$	
Isolation Voltage	Viso	Base Plate to Terminals, AC1min	2000	V	
Mounting torque	Case mounting	Ftor	M6 Screw	2.5 to 3.5	N.m
	Terminals		M8 Screw	9.0 to 10.0	

Value per 1 Arm

Electrical • Thermal Characteristics

Characteristics	Symbol	Test Conditions	Maximum Value.			Unit
			Min.	Typ.	Max.	
Peak Off-State Current	I_{DM}	$V_{DM}= V_{DRM}, T_j=125^{\circ}C$			30	mA
Peak Reverse Current	I_{RM}	$V_{RM}= V_{RRM}, T_j= 125^{\circ}C$			30	mA
Peak On-State Voltage	V_{TM}	$I_{TM}= 600A, T_j=25^{\circ}C$			1.34	V
Gate Current to Trigger	I_{GT}	$V_D=6V, I_T=1A$	$T_j=-40^{\circ}C$		300	mA
			$T_j=25^{\circ}C$		150	
			$T_j=125^{\circ}C$		80	
Gate Voltage to Trigger	V_{GT}	$V_D=6V, I_T=1A$	$T_j=-40^{\circ}C$		5	V
			$T_j=25^{\circ}C$		3	
			$T_j=125^{\circ}C$		2	
Gate Non-Trigger Voltage	V_{GD}	$V_D=2/3V_{DRM} T_j=125^{\circ}C$	0.25			V
Critical Rate of Rise of Off-State Voltage	dv/dt	$V_D=2/3V_{DRM} T_j=125^{\circ}C$	500			V/ μ s
Turn-Off Time	tq	$I_{TM}=I_O, V_D=2/3V_{DRM}$ $dv/dt=20V/\mu$ s, $V_R=100V$ $-di/dt=20A/\mu$ s, $T_j=125^{\circ}C$		100		μ s
Turn-On Time	tgt	$T_j=25^{\circ}C, I_{TM}=I_{T(RMS)}$		6		μ s
Delay Time	td	$V_D=2/3V_{DRM}, I_G=300mA$ $di/dt=0.2A/\mu$ s		2		μ s
Rise Time	tr			4		μ s
Latching Current	I_L	$T_j=25^{\circ}C$		100		mA
Holding Current	I_H	$T_j=25^{\circ}C$		60		
Thermal Resistance *1	Rth(j-c)	Junction to Case			0.23	$^{\circ}C/W$
	Rth(c-f)	Base Plate to Heat Sink with Thermal Compound			0.1	

Value Per 1Arm

*1: Value Per Module

PDT/PDH2008 OUTLINE DRAWING (Dimensions in mm)

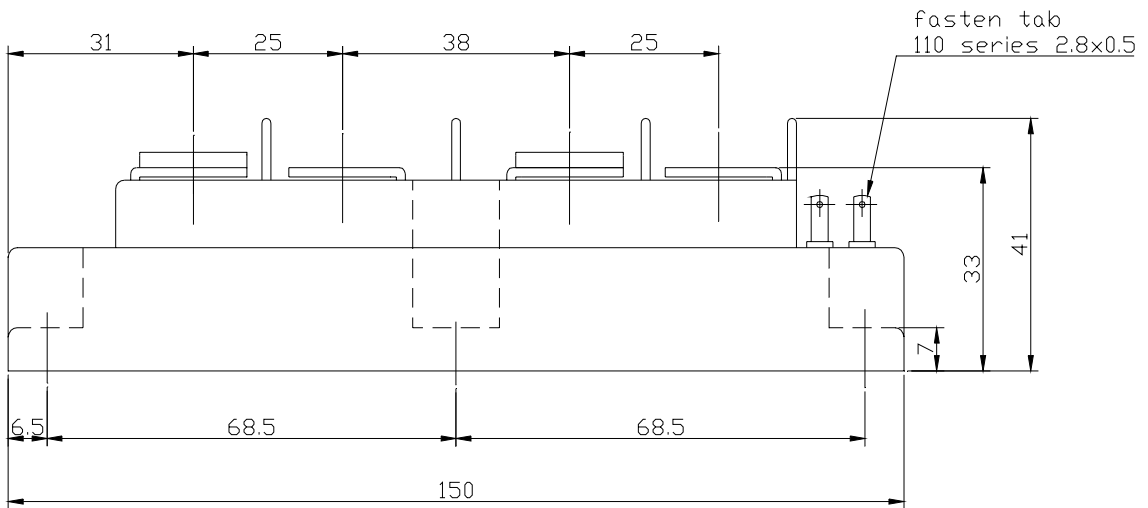
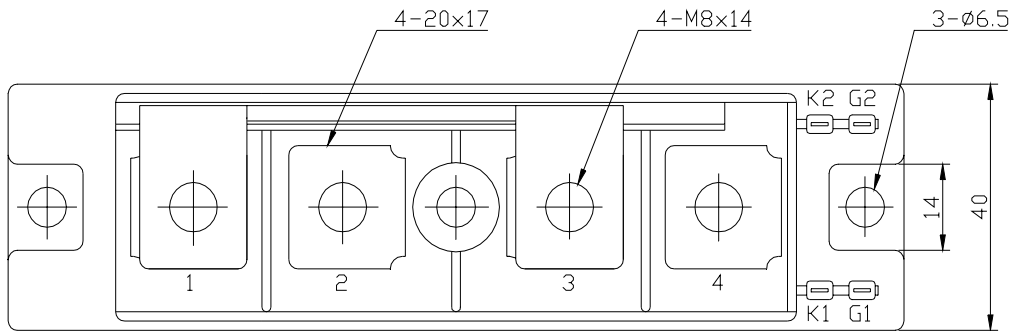

PDT

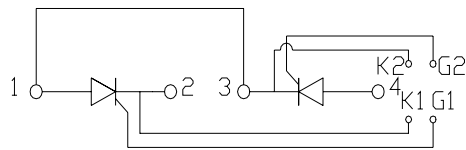

PDH

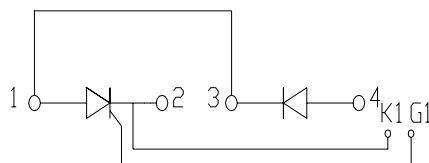

オン電圧特性
ON-STATE CURRENT VS. VOLTAGE

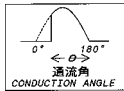
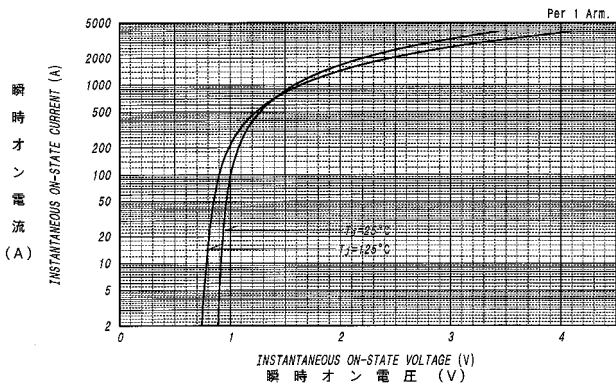

平均オン電力損失特性
AVERAGE ON-STATE POWER DISSIPATION
for SINUSOIDAL CURRENT WAVEFORM

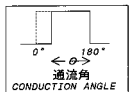
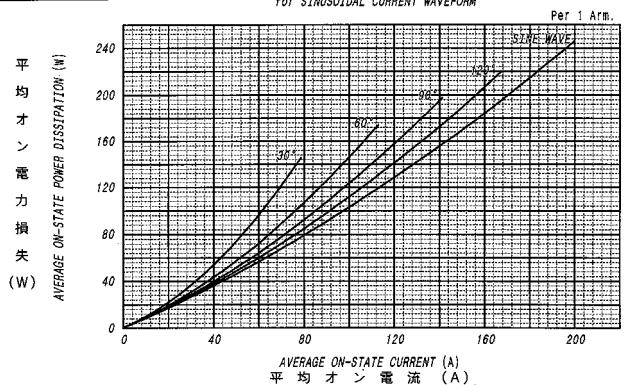

平均オン電力損失特性
AVERAGE ON-STATE POWER DISSIPATION
for RECTANGULAR CURRENT WAVEFORM

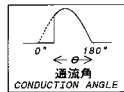
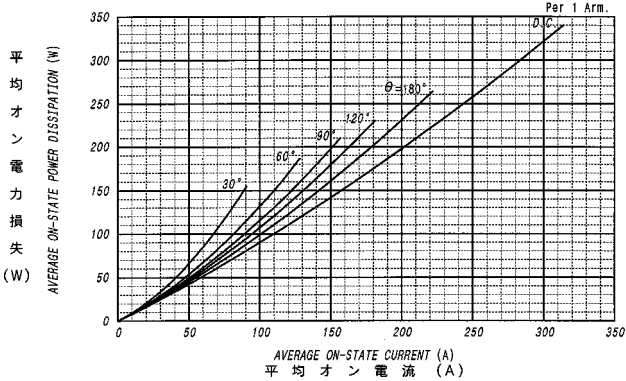

平均オン電流 - ケース温度定格
AVERAGE ON-STATE CURRENT VS. CASE TEMPERATURE

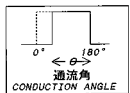
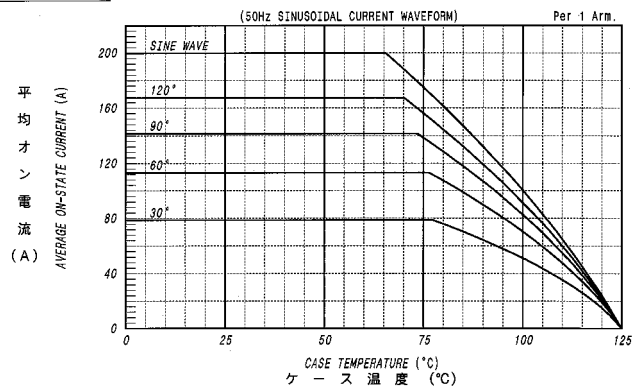

平均オン電流 - ケース温度定格
AVERAGE ON-STATE CURRENT VS. CASE TEMPERATURE

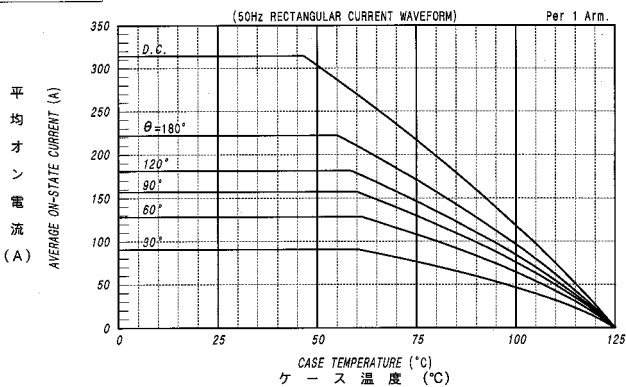

サージオン電流定格
SURGE CURRENT RATINGS

f=50Hz, Half Sine Wave, Non-Repetitive, Tj=125°C

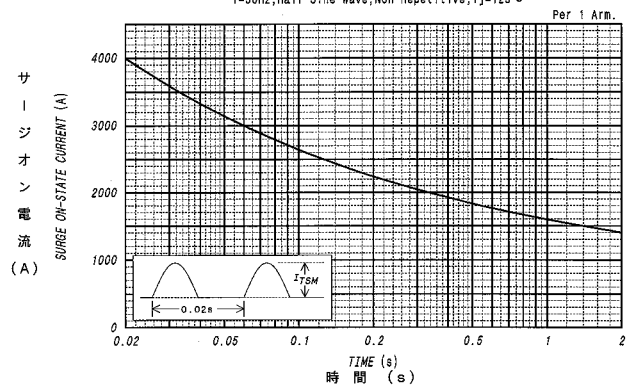

ゲート特性
GATE CHARACTERISTICS

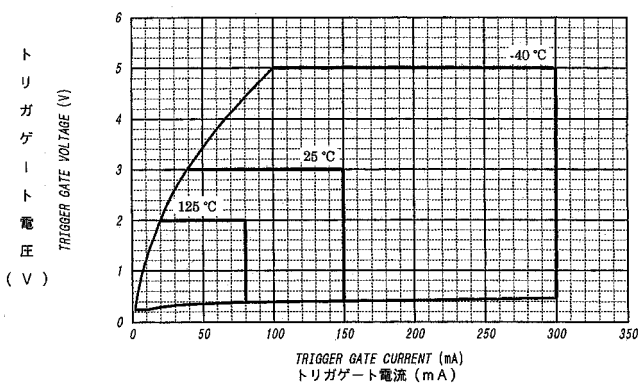

ゲート定格
GATE RATINGS

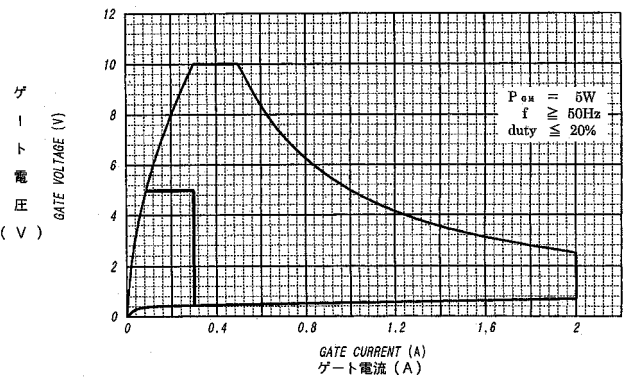

P_{on} = 5W
f = 60Hz
duty ≤ 20%

過渡熱抵抗特性
MAXIMUM TRANSIENT THERMAL IMPEDANCE

Junction to Case

Per 1 Arm.

