

MOSFET MODULE Dual 140A/500V

PDM1405HA

FEATURES

- * Dual MOSFETs Cascaded Circuit
- * Prevented Body Diodes of MOSFETs by SBDs, and Ultra Fast Recovery Diodes Connected in Parallel
- * 300KHz High Speed Switching Possible

TYPICAL APPLICATIONS

- * Power Supply for the Communications and the Induction Heating

OUTLINE DRAWING

Dimension(mm)

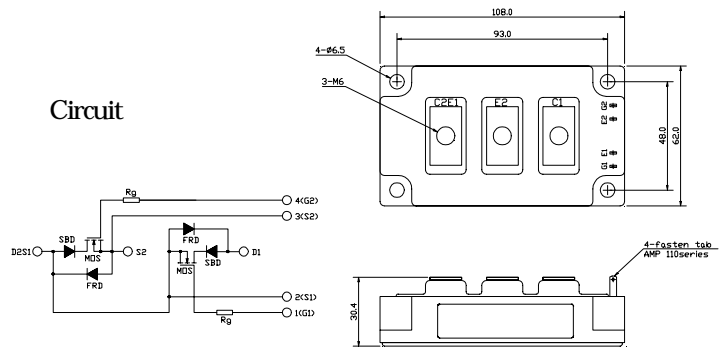

Approximate Weight : 460g

MAXMUM RATINGS

Ratings		Symbol	PDM1405HA	Unit
Drain-Source Voltage ($V_{GS}=0V$)		V_{DSS}	500	V
Gate - Source Voltage		V_{GSS}	+/- 20	V
Continuous Drain Current	Duty=50%	I_D	140 ($T_C=25^\circ C$)	A
	D.C.		100 ($T_C=25^\circ C$)	
Pulsed Drain Current		I_{DM}	280 ($T_C=25^\circ C$)	A
Total Power Dissipation		P_D	880 ($T_C=25^\circ C$)	W
Operating Junction Temperature Range		T_{jw}	-40 to +150	$^\circ C$
Storage Temperature Range		T_{stg}	-40 to +125	$^\circ C$
Isolation Voltage Terminals to Base AC, 1 min.)		V_{ISO}	2000	V
Mounting Torque	Module Base to Heatsink	F_{TOR}	3.0	N•m
	Bus Bar to Main Terminals		2.0	

ELECTRICAL CHARACTERISTICS (@ $T_C=25^\circ C$ unless otherwise noted)

Characteristic	Symbol	Test Condition	Min.	Typ.	Max.	Unit
Zero Gate Voltage Drain Current	I_{DSS}	$V_{DS}=V_{DSS}, V_{GS}=0V$	-	-	2.0	mA
		$T_J=125^\circ C, V_{DS}=0.8V_{DSS}, V_{GS}=0V$	-	-	8.0	
Gate-Source Threshold Voltage	$V_{GS(th)}$	$V_{DS}=V_{GS}, I_D=3mA$	2.0	3.1	4.0	V
Gate-Source Leakage Current	I_{GSS}	$V_{GS}=\pm 20V, V_{DS}=0V$	-	-	1.0	μA
Static Drain-Source On-Resistance	$r_{DS(on)}$	$V_{GS}=10V, I_D=70A$	-	35	40	m-ohm
Drain-Source On-Voltage	$V_{DS(on)}$	$V_{GS}=10V, I_D=70A$	-	3.0	3.4	V
Forward Transconductance	g_{fs}	$V_{DS}=15V, I_D=70A$	-	100	-	S
Input Capacitance	C_{ies}	$V_{DS}=25V, V_{GS}=0V, f=1MHz$	-	28	-	nF
Output Capacitance	C_{oss}		-	3.6	-	nF
Reverse Transfer Capacitance	C_{iss}		-	0.8	-	nF
Turn-On Delay Time	$t_{d(on)}$	$V_{DD}=1/2V_{DSS}$	-	300	-	ns
Rise Time	t_r	$I_D=70A$	-	420	-	
Turn-Off Delay Time	$t_{d(off)}$	$V_{GS}=-5V, +10V$	-	810	-	
Fall Time	t_f	$R_C=5\text{ ohm}$	-	200	-	

FREE WHEELING DIODES RATINGS & CHARACTERISTICS ($T_C=25^\circ C$)

Characteristic	Symbol	Test Condition	Min.	Typ.	Max.	Unit
Continuous Source Current	I_S	D.C.	-	-	100	A
Pulsed Source Current	I_{SM}	-	-	-	280	A
Diode Forward Voltage	V_{SD}	$I_S=140A$	-	-	1.7	V
Reverse Recovery Time	t_{rr}	$I_S=140A, -dis/dt=100A/\mu s$	-	130	-	ns
Reverse Recovery	Q_r		-	0.3	-	μC

THERMAL CHARACTERISTICS

Characteristic	Symbol	Test Condition	Min.	Typ.	Max.	Unit
Thermal Resistance, Junction to Case	$R_{th(j-c)}$	MOS FET	-	-	0.142	$^\circ C/W$
		Diode	-	-	1.0	
Thermal Resistance, Case to Heatsink	$R_{th(c-h)}$	Mounting surface flat, smooth, and greased	-	-	0.05	

PDM1405HA

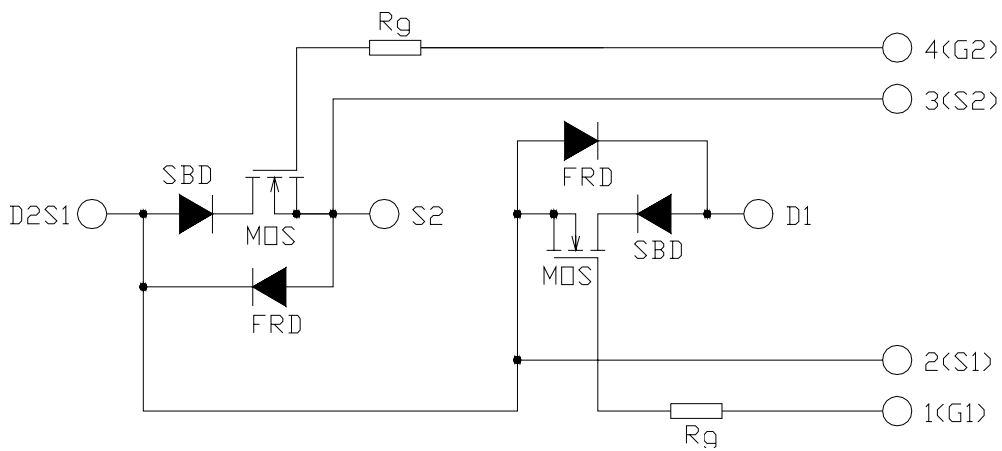
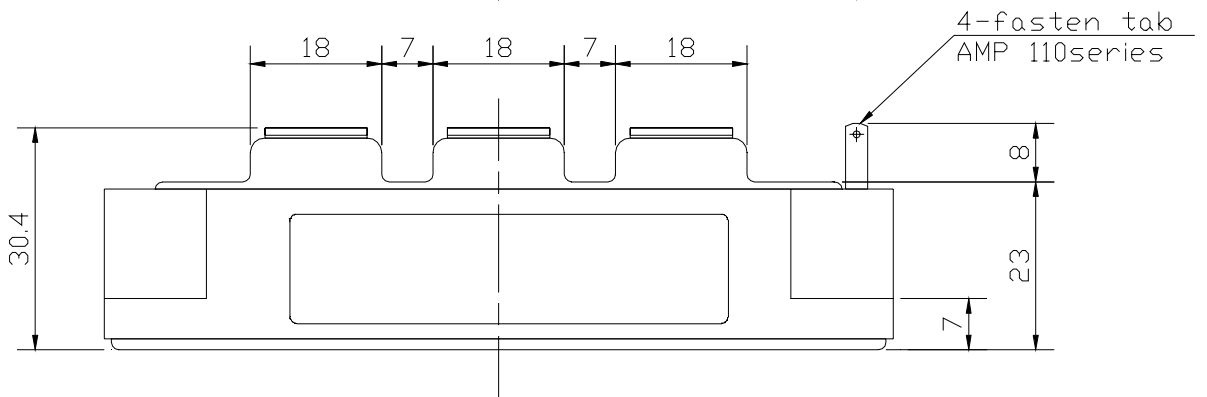
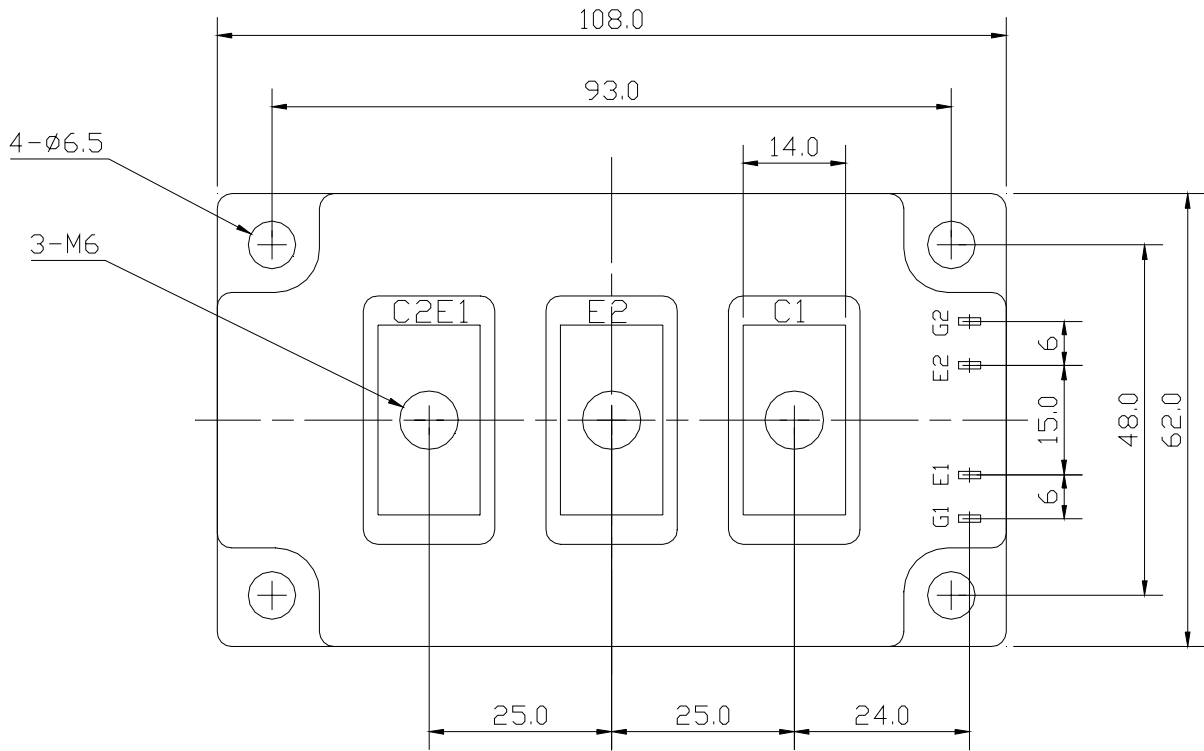

Fig. 1 Typical Output Characteristics

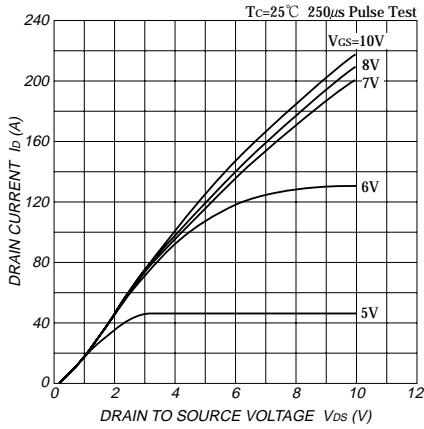

Fig. 4 Typical Capacitance Vs. Drain-Source Voltage

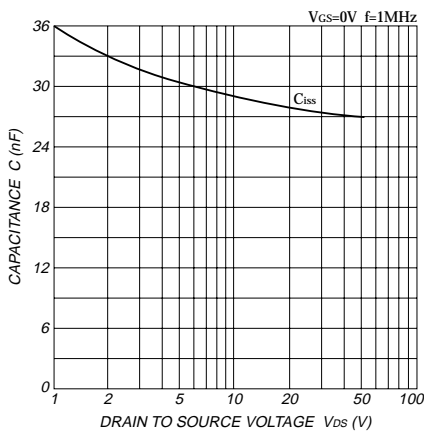

Fig. 7 Typical Switching Time Vs. Drain Current

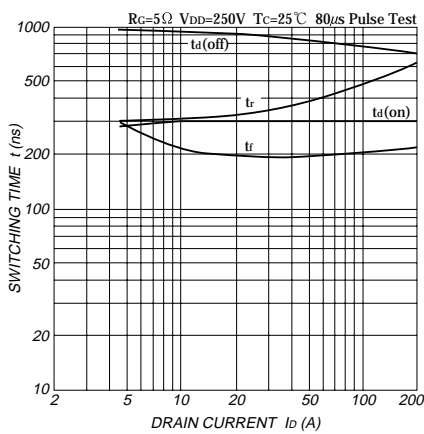

Fig. 10 Maximum Safe Operating Area

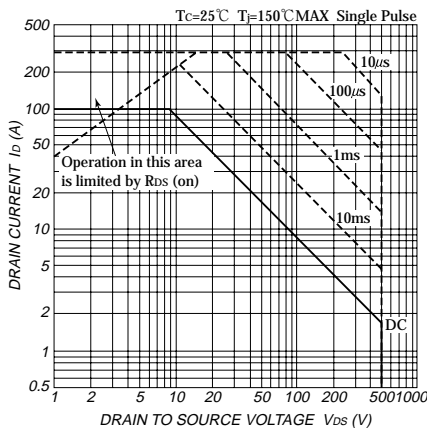

Fig. 2 Typical Drain-Source On-Voltage Vs. Gate-Source Voltage

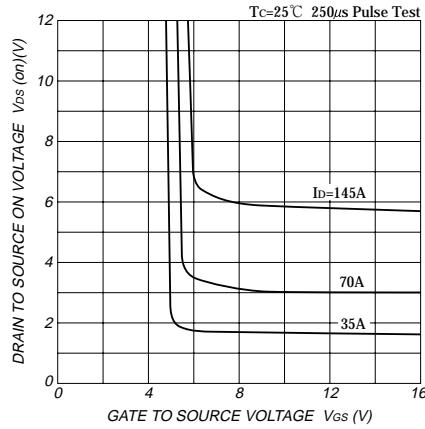

Fig. 5 Typical Gate Charge Vs. Gate-Source Voltage

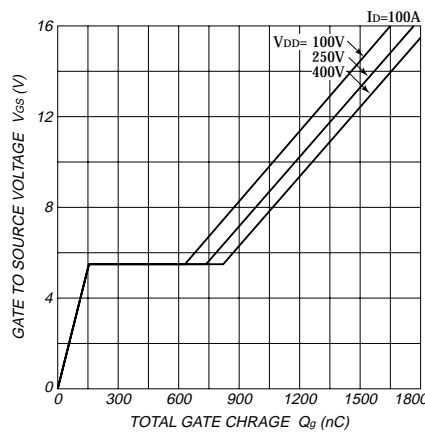

Fig. 8 Typical Source-Drain Diode Forward Characteristics

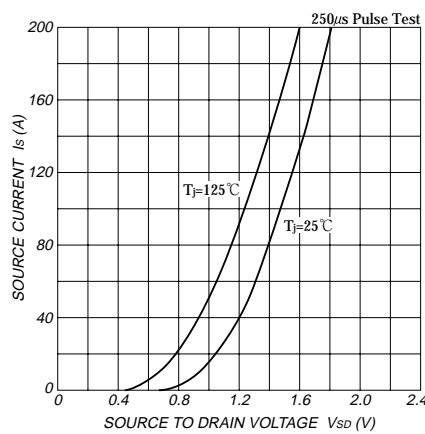

Fig. 11-1 Normalized Transient Thermal impedance(MOSFET)

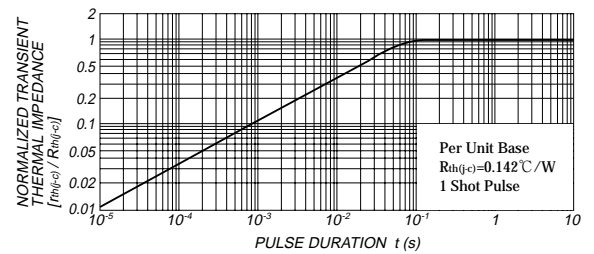

Fig. 11-2 Normalized Transient Thermal impedance(DIODE)

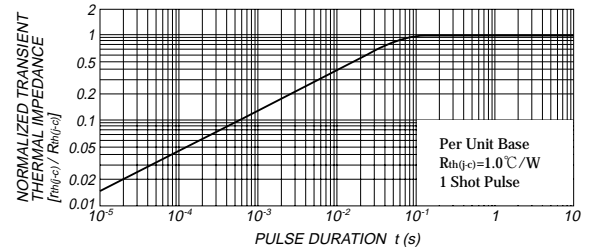

Fig. 3 Typical Drain-Source On Voltage Vs. Junction Temperature

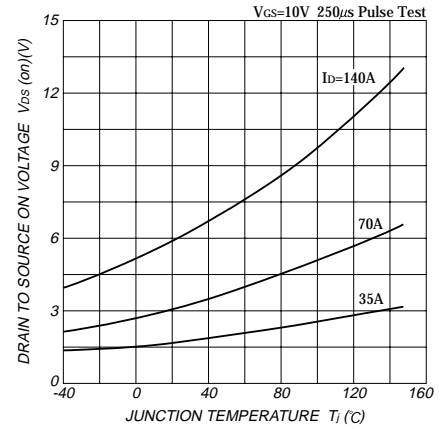

Fig. 6 Typical Switching Time Vs. Series Gate impedance

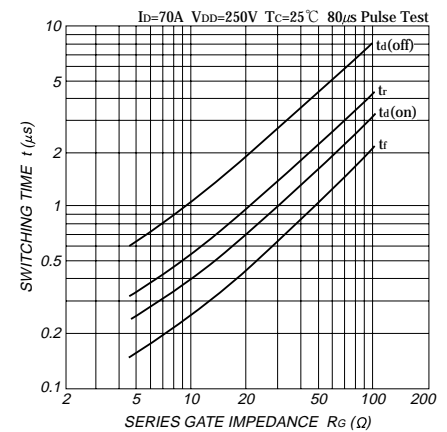

Fig. 9 Typical Reverse Recovery Characteristics

