

THYRISTOR

30A Avg 800 Volts

PDT308
PDH308
PCH308

回路図 CIRCUIT

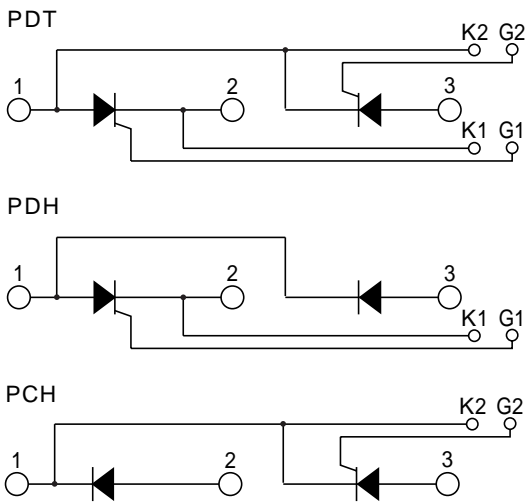

外形寸法図 OUTLINE DRAWING

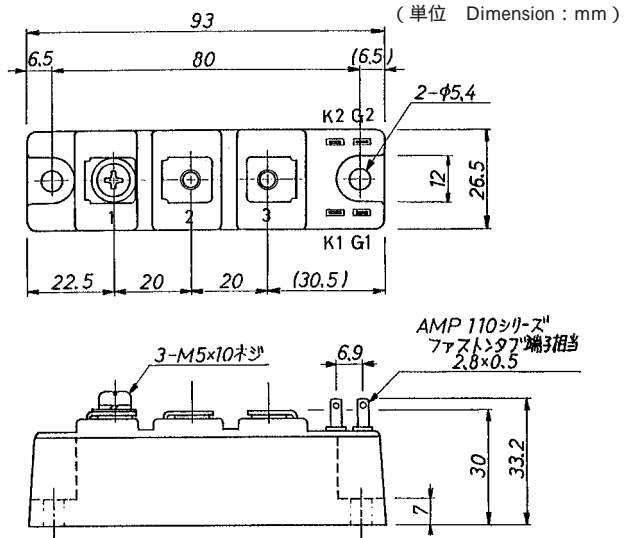

最大定格 Maximum Ratings

項目 Parameter	記号 Symbol	耐圧クラス Grade		単位 Unit
		PDT308/PDH308/PCH308		
くり返しピークオフ電圧 Repetitive Peak Off-State Voltage	V_{DRM}	800		V
非くり返しピークオフ電圧 Non Repetitive Peak Off-State Voltage	V_{DSM}	960		V
くり返しピーク逆電圧 Repetitive Peak Reverse Voltage	V_{RRM}	800		V
非くり返しピーク逆電圧 Non Repetitive Peak Reverse Voltage	V_{RSM}	960		V

項目 Parameter	記号 Symbol	条件 Conditions	定格値 Max. Rated Value	単位 Unit		
平均整流電流 Average Rectified Output Current	$I_{\alpha(AV)}$	商用周波数 180° 通電 Half Sine Wave $T_c = 95$	30	A		
実効オン電流 RMS On-State Current	$I_{T(RMS)}$		47	A		
サージオン電流 Surge On-State Current	I_{TSM}	50Hz正弦半波, 1 サイクル, 非くり返し Half Sine Wave, 1Pulse, Non-Repetitive	600	A		
電流二乗時間積 I Squared t	I^2t	2 ~ 10ms	1800	A^2s		
臨界オン電流上昇率 Critical Rate of Rise of Turned-On Current	di/dt	$V_D = 2/3 V_{DRM}$, $I_{TM} = 2 \cdot I_{\alpha}$, $T_j = 125$ $I_G = 200mA$, $di_G/dt = 0.2A/\mu s$	100	$A/\mu s$		
ピークゲート電力損失 Peak Gate Power	P_{GM}		5	W		
平均ゲート電力損失 Average Gate Power	$P_{G(AV)}$		1	W		
ピークゲート電流 Peak Gate Current	I_{GM}		2	A		
ピークゲート電圧 Peak Gate Voltage	V_{GM}		10	V		
ピークゲート逆電圧 Peak Gate Reverse Voltage	V_{RGM}		5	V		
動作接合温度範囲 Operating Junction Temperature Range	T_{jw}		- 40 ~ + 125			
保存温度範囲 Storage Temperature Range	T_{stg}		- 40 ~ + 125			
絶縁耐圧 Isolation Voltage	V_{iso}	端子 - ベース間, AC 1 分間 Terminal to Base, AC 1 min.	2000	V		
締付トルク Mounting Torque	ベース部 Mounting	F	サーマルコンパウンド塗布 Greased	M5	2.4 ~ 2.8	N·m
	主端子部 Terminal		M5	2.4 ~ 2.8	N·m	

1 アーム当りの値 Value Per 1 Arm.

電気的特性 Electrical Characteristics

項目 Parameter	記号 Symbol	条件 Conditions	特性値(最大) Maximum Value			単位 Unit
			最小 Min.	標準 Typ.	最大 Max.	
ピークオフ電流 Peak Off-State Current	I_{DM}	$T_j=125$, $V_{DM}=V_{DRM}$			10	mA
ピーク逆電流 Peak Reverse Current	I_{RM}	$T_j=125$, $V_{RM}=V_{RRM}$			10	mA
ピークオン電圧 Peak On-State Voltage	V_{TM}	$T_j=25$, $I_{TM}=90A$			1.45	V
トリガゲート電流 Gate Current to Trigger	I_{GT}	$V_D=6V$, $I_T=1A$	$T_j=-40$		200	mA
			$T_j=25$		100	mA
			$T_j=125$		50	mA
トリガゲート電圧 Gate Voltage to Trigger	V_{GT}	$V_D=6V$, $I_T=1A$	$T_j=-40$		4	V
			$T_j=25$		2.5	V
			$T_j=125$		2	V
非トリガゲート電圧 Gate Non-Trigger Voltage	V_{GD}	$T_j=125$, $V_D=2/3V_{DRM}$	0.25			V
臨界オフ電圧上昇率 Critical Rate of Rise of Off-State Voltage	dv/dt	$T_j=125$, $V_D=2/3V_{DRM}$	500			V/ μ s
ターンオフ時間 Turn-Off Time	t_q	$T_j=125$, $I_{TM}=I_o$, $V_D=2/3V_{DRM}$ $dv/dt=20V/\mu$ s , $V_R=100V$, $-di/dt=20A/\mu$ s		100		μ s
ターンオン時間 Turn-On Time	t_{gt}			6		μ s
遅れ時間 Delay Time	t_d	$T_j=25$, $V_D=2/3V_{DRM}$ $I_G=200mA$, $di/dt=0.2A/\mu$ s		2		μ s
立上がり時間 Rise Time	t_r			4		μ s
ラッチング電流 Latching Current	I_L	$T_j=25$		100		mA
保持電流 Holding Current	I_H	$T_j=25$		50		mA
熱抵抗 Thermal Resistance	$R_{th(j-c)}$	接合部 - ケース間 Junction to Case			0.7	/W
接触熱抵抗 Thermal Resistance	$R_{th(c-f)}$	ケース - フィン間, サーマルコンパウンド塗布 Case to Fin, Greased			0.2	/W

質量...約155g
Approximate Weight

1 アーム当りの値 Value Per 1 Arm.

オン電圧特性
ON-STATE CURRENT VS. VOLTAGE

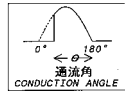
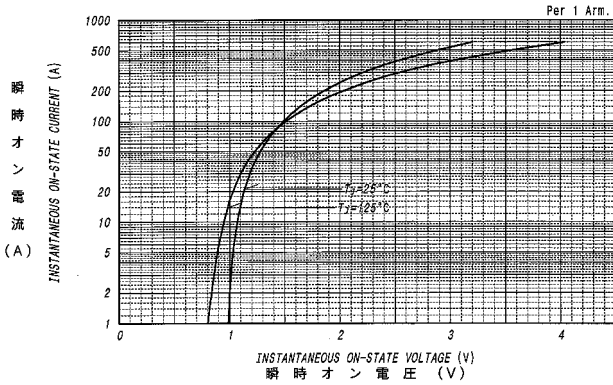

平均オン電力損失特性
AVERAGE ON-STATE POWER DISSIPATION
for SINUSOIDAL CURRENT WAVEFORM

平均オン電力損失 (W)

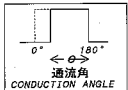
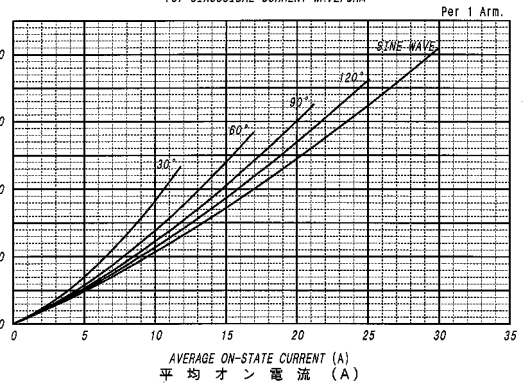

平均オン電力損失特性
AVERAGE ON-STATE POWER DISSIPATION
for RECTANGULAR CURRENT WAVEFORM

平均オン電力損失 (W)

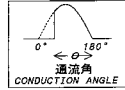
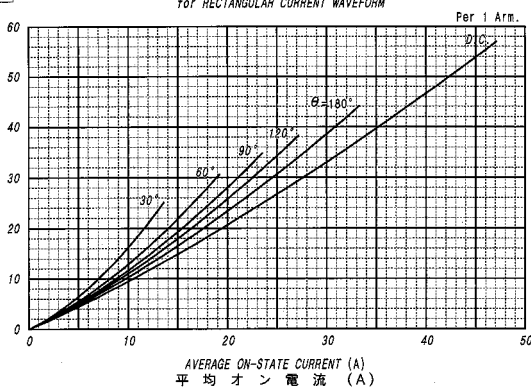

平均オン電流 - ケース温度定格
AVERAGE ON-STATE CURRENT VS. CASE TEMPERATURE

平均オン電流 (A)

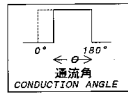
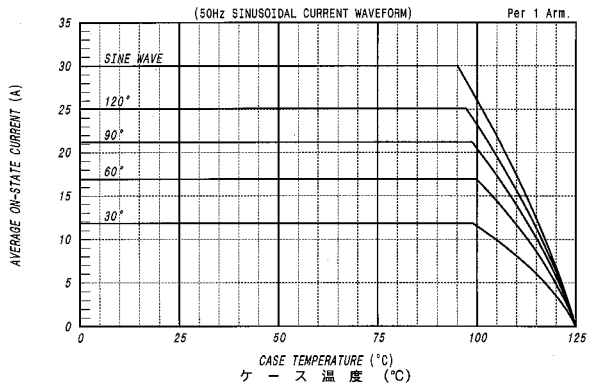

平均オン電流 - ケース温度定格
AVERAGE ON-STATE CURRENT VS. CASE TEMPERATURE

平均オン電流 (A)

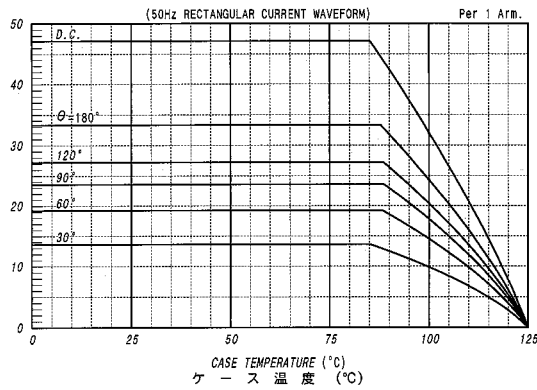

サージオン電流定格
SURGE CURRENT RATINGS

サージオン電流 (A)

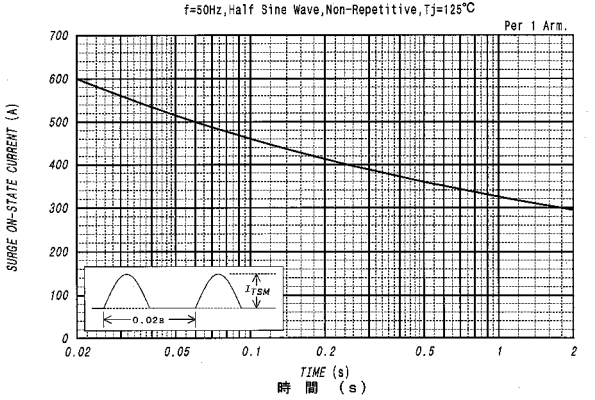

ゲート特性
GATE CHARACTERISTICS

トリガゲート電圧 (V)

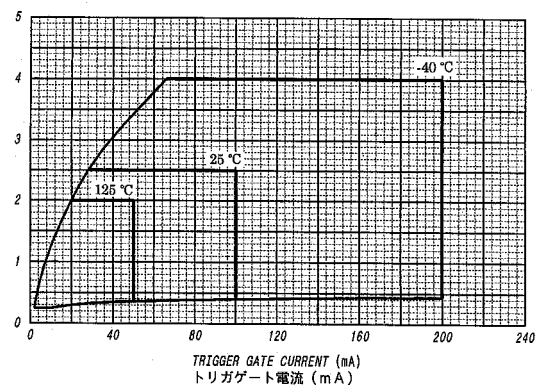

ゲート定格
GATE RATINGS

ゲート電圧 (V)

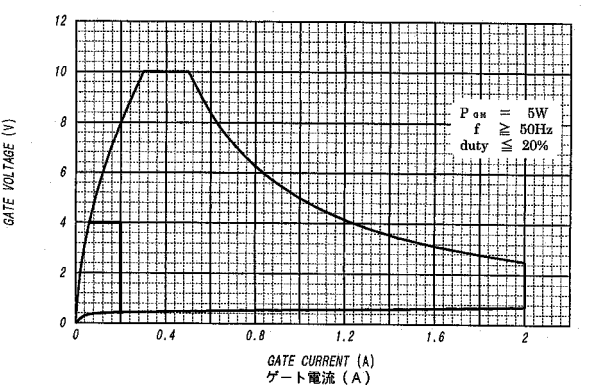

過渡熱抵抗特性
 MAXIMUM TRANSIENT THERMAL IMPEDANCE
 Junction to Case

