

THYRISTOR MODULE

PDT15116 PDH15116

150A / 1600V

OUTLINE DRAWING

FEATURES

- * 108mm Short Size Case
- * Isolated Base
- * Dual Thyristors or Thyristor and Diode Cascaded Circuit
- * High Surge Capability
- * UL Recognized, File No. E187184

TYPICAL APPLICATIONS

- * Rectified For General Use

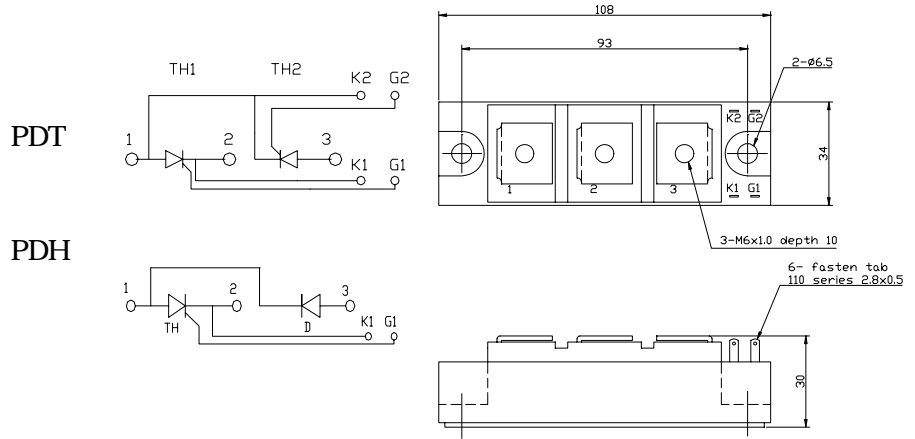

Maximum Ratings

Approx Net Weight:280g

| Parameter | Symbol | Grade | Unit |
|---------------------------------------|-----------|--------------|------|
| | | PDT/PDH15116 | |
| Repetitive Peak Off-State Voltage | V_{DRM} | 1600 | V |
| Non Repetitive Peak Off-State Voltage | V_{DSM} | 1700 | |
| Repetitive Peak Reverse Voltage | V_{RRM} | 1600 | V |
| Non Repetitive Peak Reverse Voltage | V_{RSM} | 1700 | |

| Parameter | | Conditions | Max Rated Value | Unit |
|--------------------------------------|---------------|--|-----------------|-------------|
| Average Rectified Output Current | $I_{O(AV)}$ | 50Hz Half Sine Wave condition $T_c=73^{\circ}C$ | 150 | A |
| RMS On-State Current | $I_{T(RMS)}$ | | 235 | A |
| Surge On-State Current | I_{TSM} | 50 Hz Half Sine Wave, 1Pulse Non-Repetitive | 3200 | A |
| I Squared t | I^2t | 2msec to 10msec | 51200 | A^2s |
| Critical Rate of Turned-On Current | di/dt | $V_D=2/3V_{DRM}$, $I_{TM}=2 \cdot I_o$, $T_j=125^{\circ}C$ $I_G=300mA$, $di_G/dt=0.2A/\mu s$ | 100 | $A/\mu s$ |
| Peak Gate Power | P_{GM} | | 5 | W |
| Average Gate Power | $P_{G(AV)}$ | | 1 | W |
| Peak Gate Current | I_{GM} | | 2 | A |
| Peak Gate Voltage | V_{GM} | | 10 | V |
| Peak Gate Reverse Voltage | V_{RGM} | | 5 | V |
| Operating Junction Temperature Range | T_{jw} | | -40 to +125 | $^{\circ}C$ |
| Storage Temperature Range | T_{stg} | | -40 to +125 | $^{\circ}C$ |
| Isolation Voltage | Viso | Base Plate to Terminals, AC1min | 2500 | V |
| Mounting torque | Case mounting | Ftor | M6 Screw | N.m |
| | Terminals | | M6 Screw | |

Value per 1 Arm

Electrical • Thermal Characteristics

| Characteristics | Symbol | Test Conditions | Maximum Value. | | | Unit |
|--|----------|---|---------------------------|------|------|---------------------------|
| | | | Min. | Typ. | Max. | |
| Peak Off-State Current | I_{DM} | $V_{DM} = V_{DRM}, T_j = 125^\circ\text{C}$ | | | 50 | mA |
| Peak Reverse Current | I_{RM} | $V_{RM} = V_{RRM}, T_j = 125^\circ\text{C}$ | | | 50 | mA |
| Peak Forward Voltage | V_{TM} | $I_{TM} = 450\text{A}, T_j = 25^\circ\text{C}$ | | | 1.38 | V |
| Gate Current to Trigger | I_{GT} | $V_D = 6\text{V}, I_T = 1\text{A}$ | $T_j = -40^\circ\text{C}$ | | 300 | mA |
| | | | $T_j = 25^\circ\text{C}$ | | 150 | |
| | | | $T_j = 125^\circ\text{C}$ | | 80 | |
| Gate Voltage to Trigger | V_{GT} | $V_D = 6\text{V}, I_T = 1\text{A}$ | $T_j = -40^\circ\text{C}$ | | 5 | V |
| | | | $T_j = 25^\circ\text{C}$ | | 3 | |
| | | | $T_j = 125^\circ\text{C}$ | | 2 | |
| Gate Non-Trigger Voltage | V_{GD} | $V_D = 2/3V_{DRM}, T_j = 125^\circ\text{C}$ | 0.25 | | | V |
| Critical Rate of Rise of Off-State Voltage | dv/dt | $V_D = 2/3V_{DRM}, T_j = 125^\circ\text{C}$ | 500 | | | V/ μs |
| Turn-Off Time | tq | $I_{TM} = I_O, V_D = 2/3V_{DRM}$ $dv/dt = 20\text{V}/\mu\text{s}, V_R = 100\text{V}$ $-di/dt = 20\text{A}/\mu\text{s}, T_j = 125^\circ\text{C}$ | | 100 | | μs |
| Turn-On Time | tgt | $V_D = 2/3V_{DRM}, T_j = 125^\circ\text{C}$ $I_G = 300\text{mA}, di_G/dt = 0.2\text{A}/\mu\text{s}$ | | 6 | | μs |
| Delay Time | td | | | 2 | | μs |
| Rise Time | tr | | | 4 | | μs |
| Latching Current | I_L | $T_j = 25^\circ\text{C}$ | | 120 | | mA |
| Holding Current | I_H | $T_j = 25^\circ\text{C}$ | | 80 | | |
| Thermal Resistance | Rth(j-c) | Junction to Case | | | 0.25 | $^\circ\text{C}/\text{W}$ |
| | Rth(c-f) | Base Plate to Heat Sink with Thermal Compound | | | 0.15 | |

Value Per 1Arm

PDT/PDH15116 OUTLINE DRAWING (Dimensions in mm)

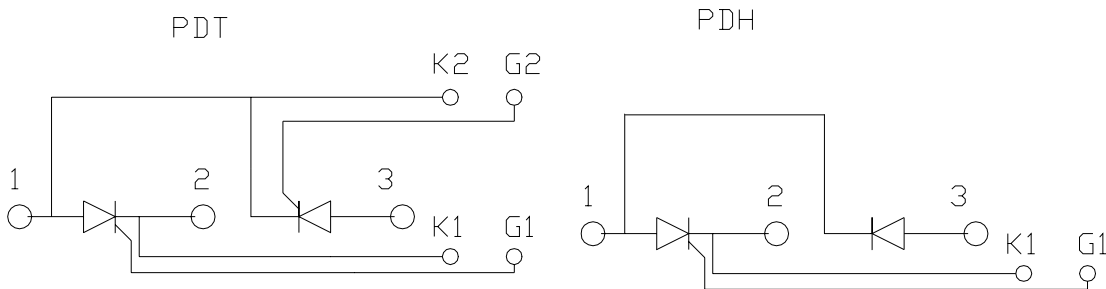
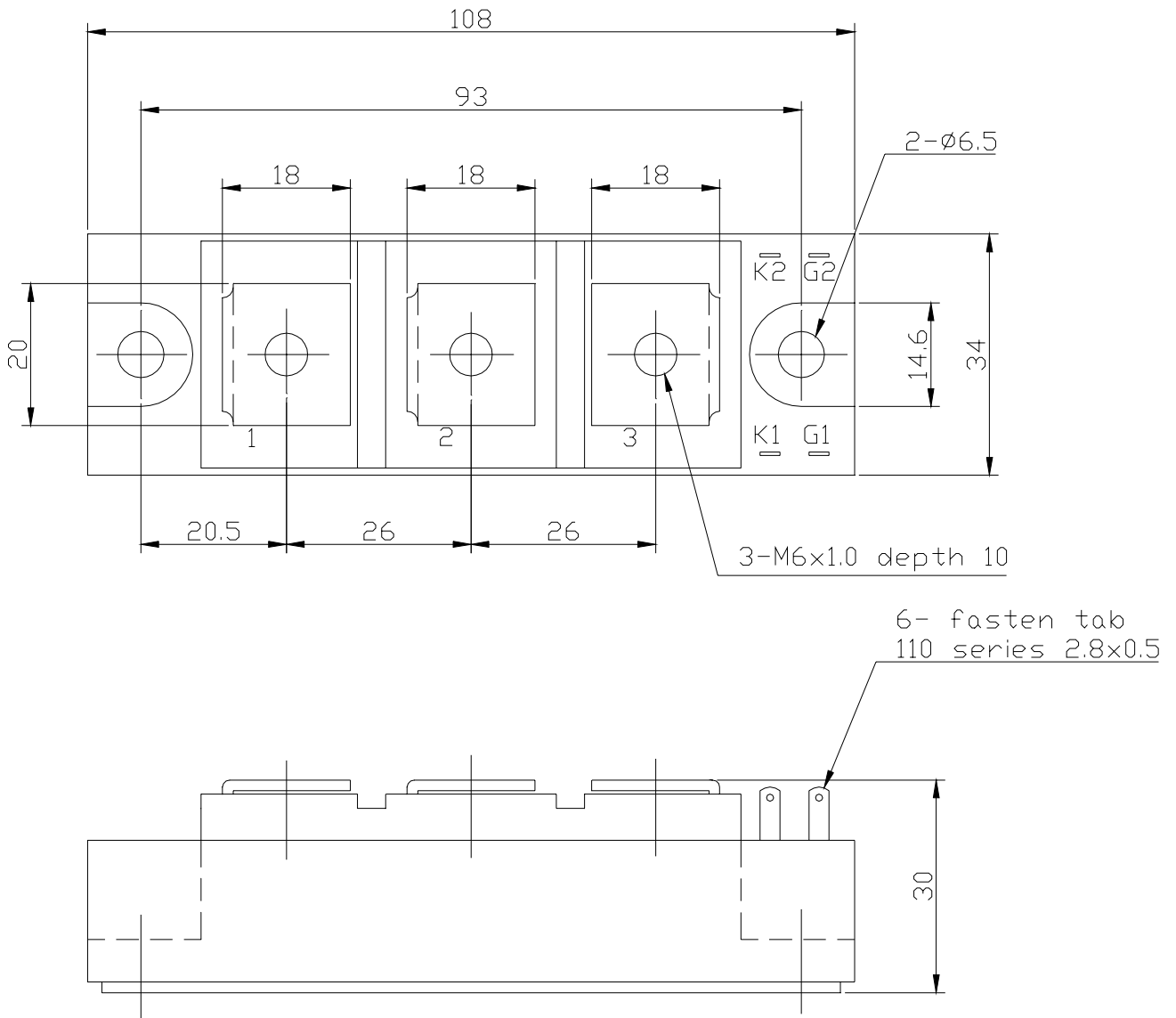

ON-STATE CURRENT VS. VOLTAGE

PDT/PDH15116

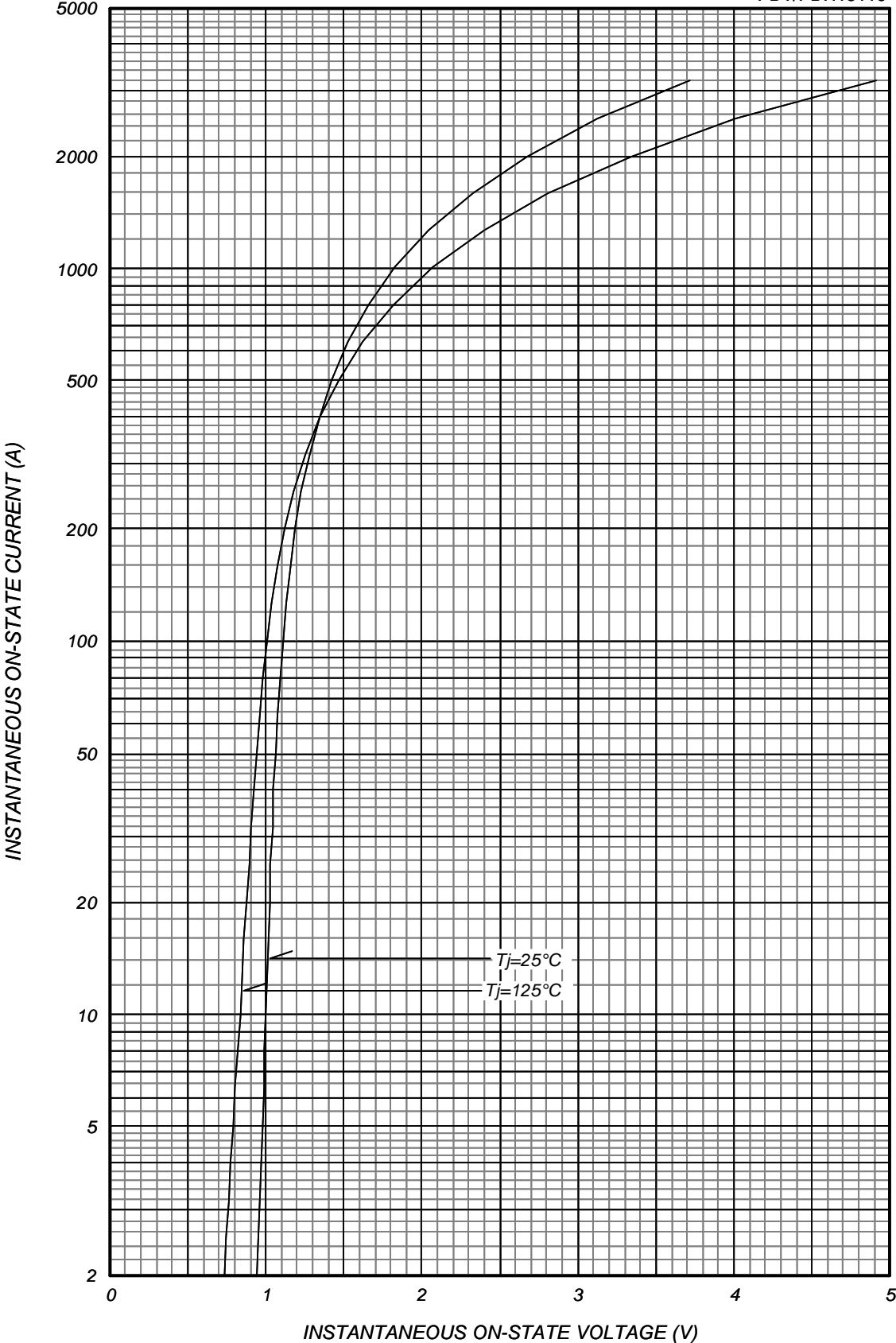

AVERAGE ON-STATE POWER DISSIPATION

for

PDT/PDH15116

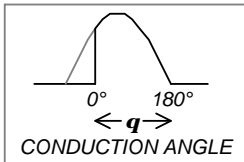
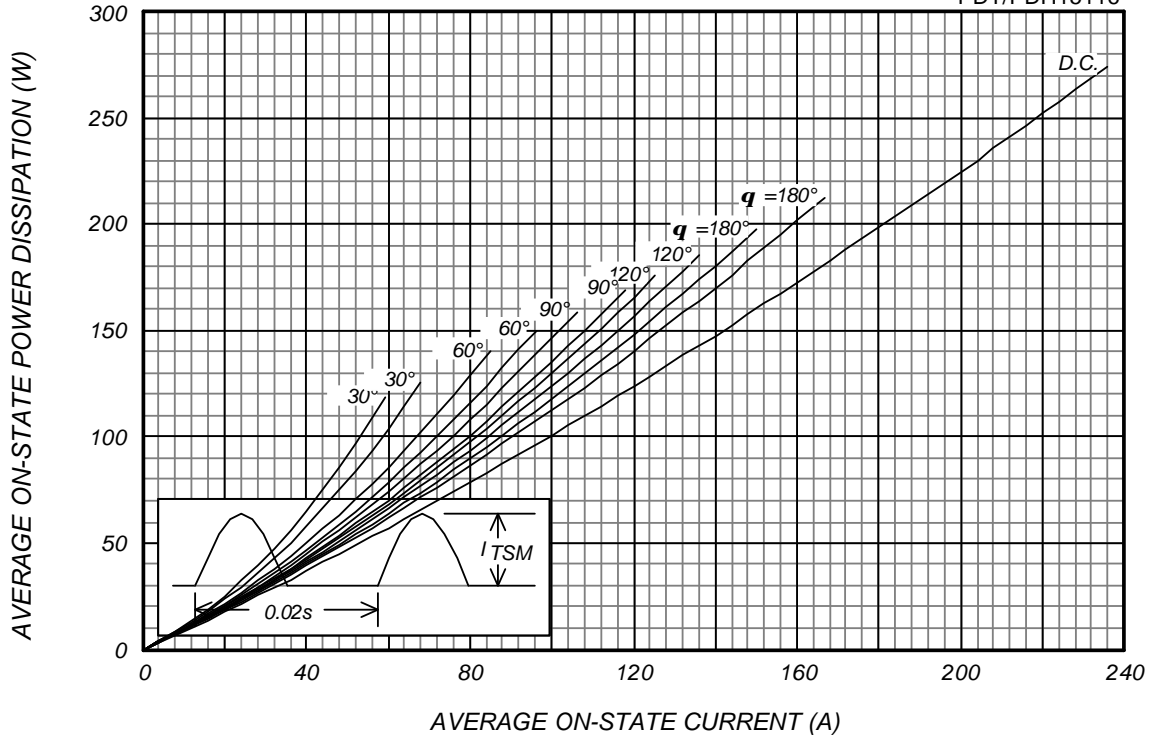

AVERAGE ON-STATE CURRENT VS. CASE TEMPERATURE

(50Hz SINUSOIDAL CURRENT WAVEFORM)

PDT/PDH15116

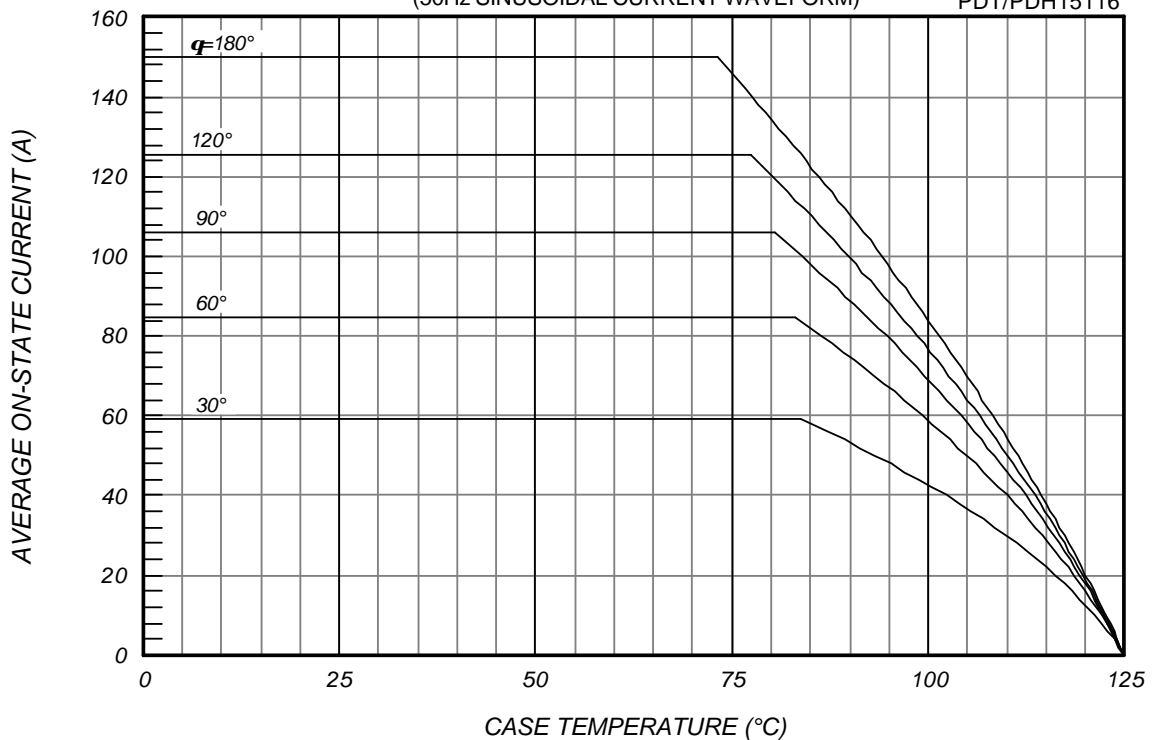

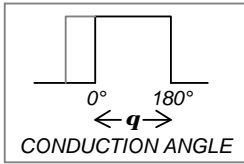

AVERAGE ON-STATE CURRENT VS. CASE TEMPERATURE

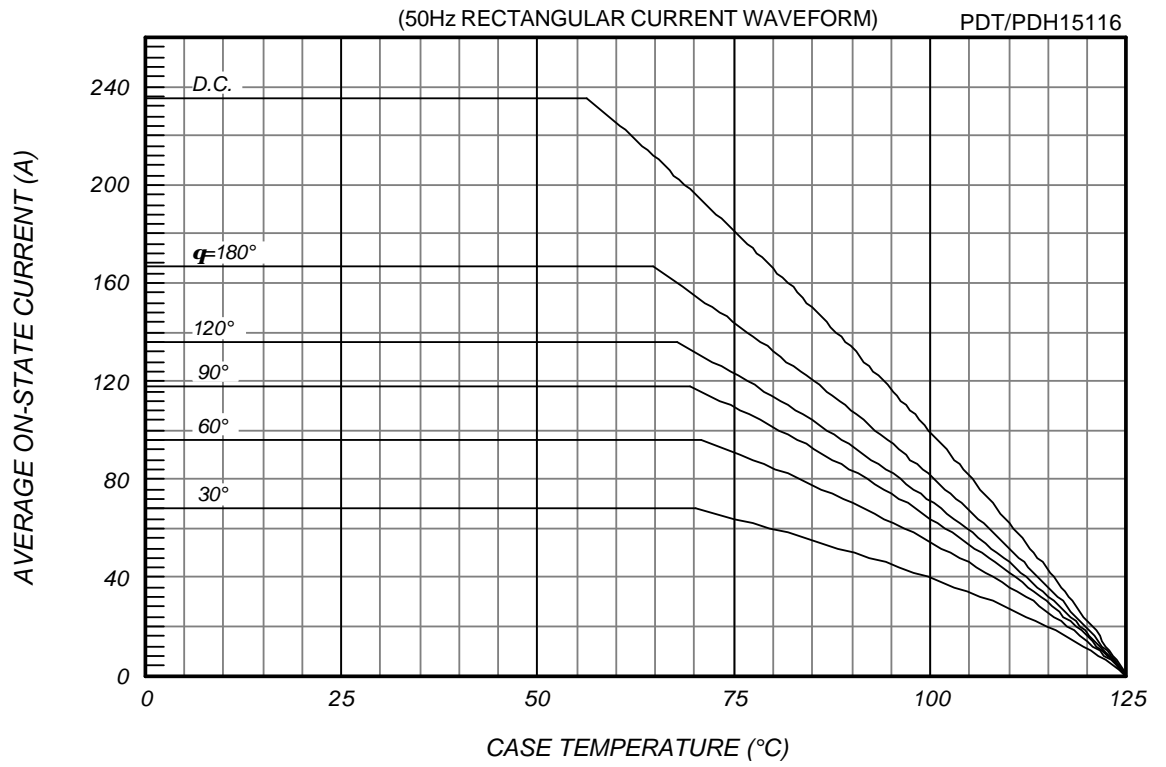

GATE CHARACTERISTICS

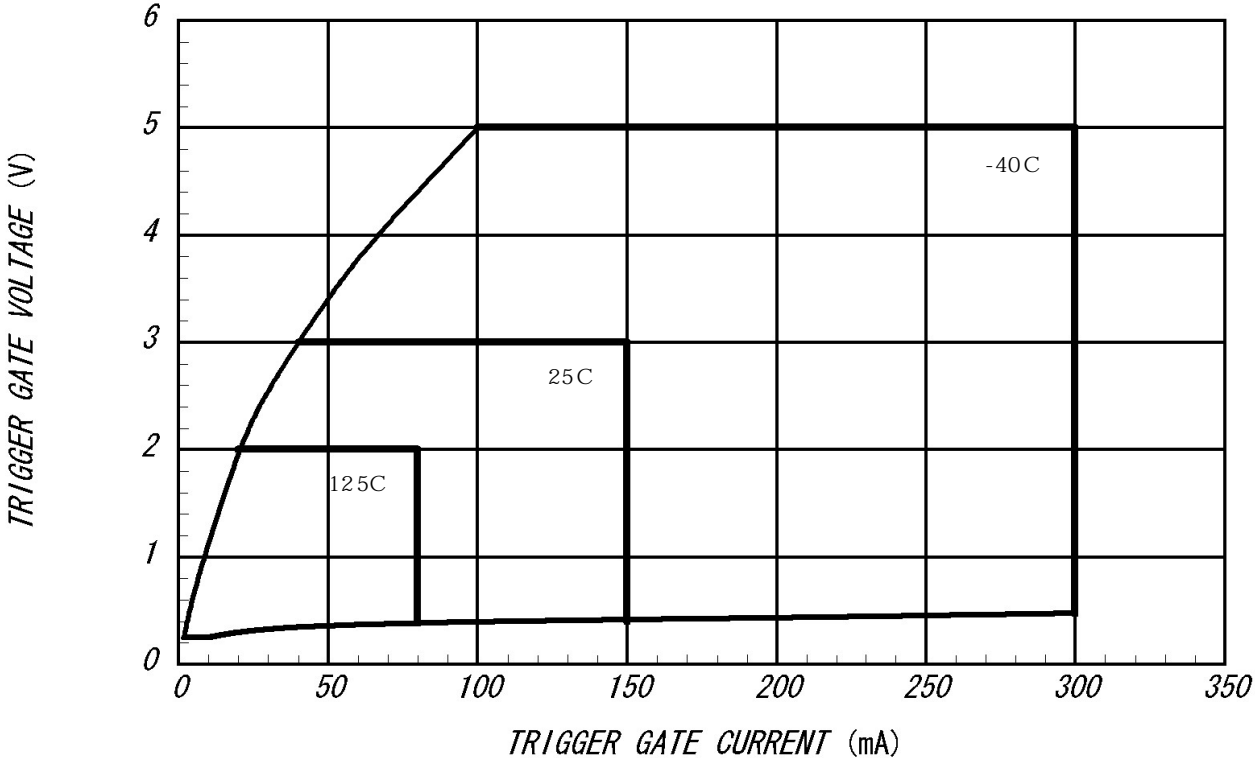

GATE RATINGS

$P_{CM}=5W$
 $f > 50Hz$
 $duty < 20\%$

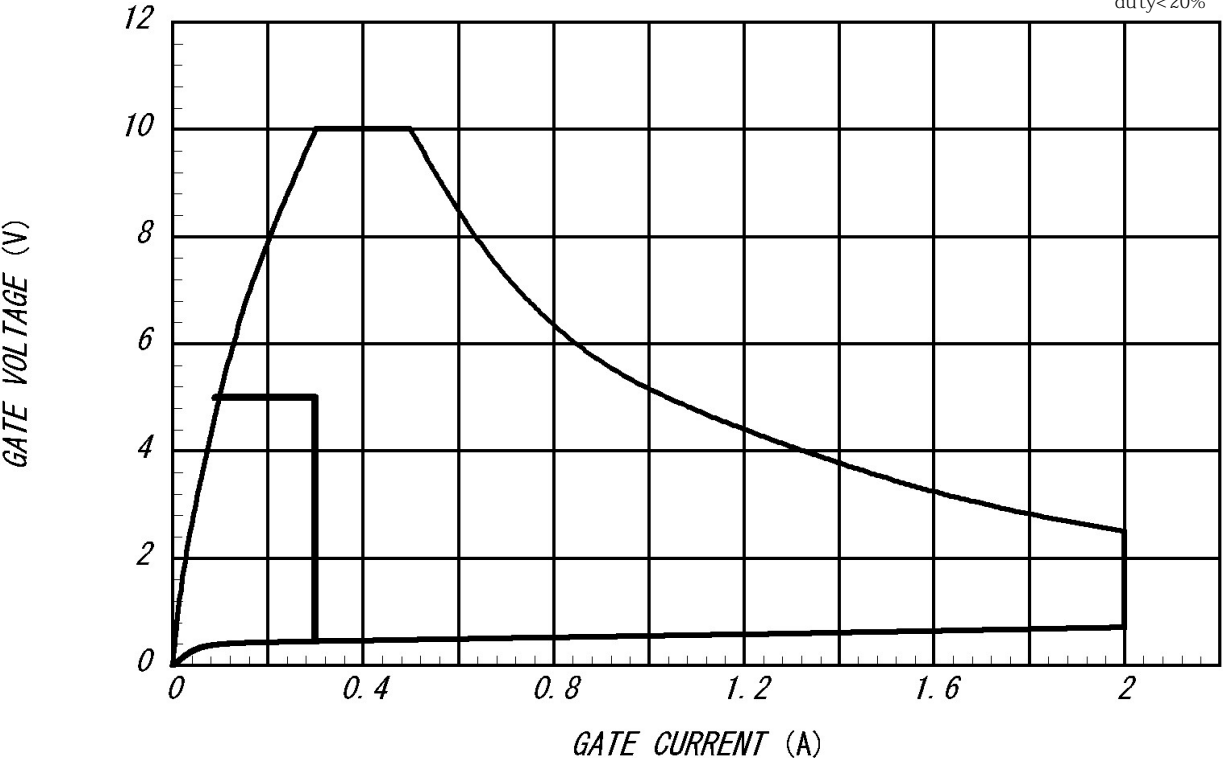

SURGE CURRENT RATINGS

f=50Hz, Half Sine Wave, Non-Repetitive, On Load

PDT/PDH15116

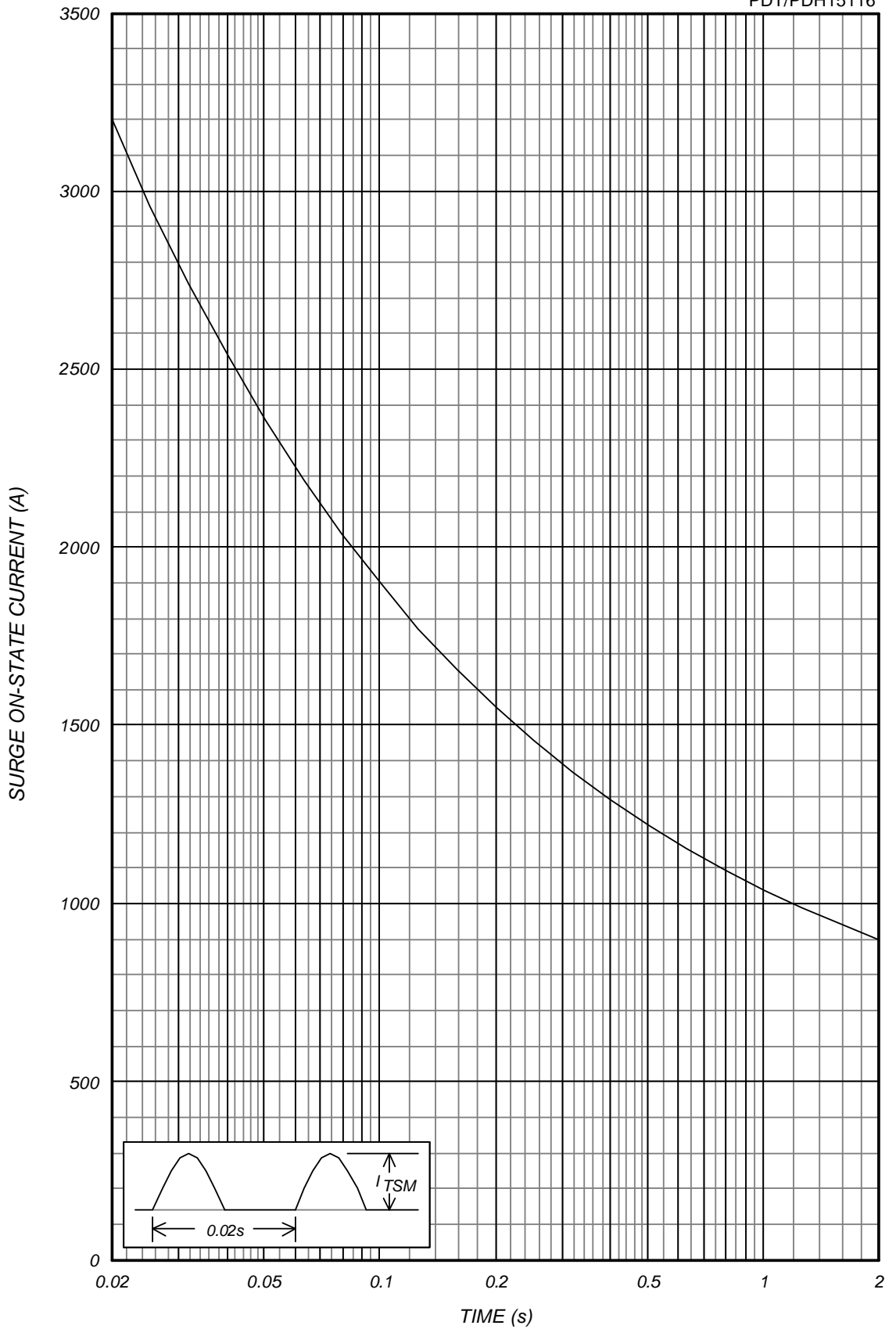

MAXIMUM TRANSIENT THERMAL IMPEDANCE

Junction to Case

PDT/PDH15116

