

Powerex, Inc., Hillis Street, Youngwood, Pennsylvania 15697 (724) 925-7272

POW-R-BLOK™
Dual SCR Isolated Module
600 Amperes / Up to 2400 Volts



Description:

Powerex Dual SCR Modules are designed for use in applications requiring phase control and isolated packaging. The modules are isolated for easy mounting with other components on a common heatsink.

Features:

- Electrically Isolated Heatsinking
- Compression Bonded Elements
- Metal Baseplate
- Low Thermal Impedance for Improved Current Capability

Benefits:

- No Additional Insulation Components Required
- Easy Installation
- No Clamping Components Required
- Reduce Engineering Time

Applications:

- Bridge Circuits
- AC & DC Motor Drives
- Motor Soft Starters
- Battery Supplies
- Power Supplies
- Large IGBT Circuit Front Ends

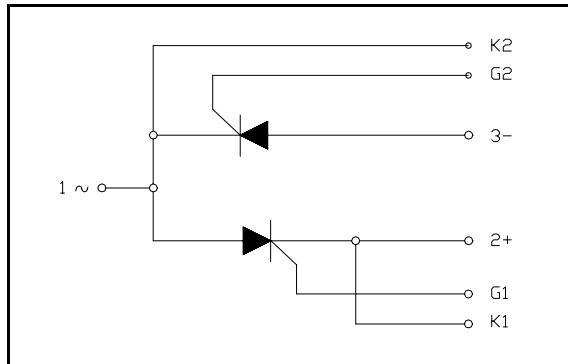

Ordering Information:

Select the complete eight-digit module part number from the table below.

Example: PD432406 is a 2400 Volt, 600A Average Dual SCR Isolated POW-R-BLOK™ Module

Type	Voltage Volts (x100)	Current Amperes (x100)
PD43	20	06
	22	
	24	

Powerex, Inc., Hillis Street, Youngwood, Pennsylvania 15697 (724) 925-7272

POW-R-BLOK™
Dual SCR Isolated Module
600 Amperes / Up to 2400 Volts

Absolute Maximum Ratings

Characteristics	Conditions	Symbol	Units
Repetitive Peak Forward and Reverse Blocking Voltage		V_{DRM} & V_{RRM}	Up to 2400 V
Non-Repetitive Peak Blocking Voltage ($t < 5$ msec)		V_{RSM}	$V_{RRM} + 100V$ V
RMS Current AC Switch Configuration (180° Conduction)	180° Conduction, $T_C=66^\circ C$	$I_{T(RMS)}$	1665 A
	180° Conduction, $T_C=71^\circ C$	$I_{T(RMS)}$	1550 A
	180° Conduction, $T_C=76^\circ C$	$I_{T(RMS)}$	1440 A
	180° Conduction, $T_C=81^\circ C$	$I_{T(RMS)}$	1330 A
	180° Conduction, $T_C=86^\circ C$	$I_{T(RMS)}$	1220 A
	180° Conduction, $T_C=90^\circ C$	$I_{T(RMS)}$	1110 A
RMS Current Per SCR (180° Conduction)	180° Conduction, $T_C=66^\circ C$	$I_{T(RMS)}$	1178 A
	180° Conduction, $T_C=71^\circ C$	$I_{T(RMS)}$	1100 A
	180° Conduction, $T_C=76^\circ C$	$I_{T(RMS)}$	1020 A
	180° Conduction, $T_C=81^\circ C$	$I_{T(RMS)}$	942 A
	180° Conduction, $T_C=86^\circ C$	$I_{T(RMS)}$	864 A
	180° Conduction, $T_C=90^\circ C$	$I_{T(RMS)}$	785 A
Average Forward Current Per SCR (180° Conduction)	180° Conduction, $T_C=66^\circ C$	$I_{T(AV)}$	750 A
	180° Conduction, $T_C=71^\circ C$	$I_{T(AV)}$	700 A
	180° Conduction, $T_C=76^\circ C$	$I_{T(AV)}$	650 A
	180° Conduction, $T_C=81^\circ C$	$I_{T(AV)}$	600 A
	180° Conduction, $T_C=86^\circ C$	$I_{T(AV)}$	550 A
	180° Conduction, $T_C=90^\circ C$	$I_{T(AV)}$	500 A
Peak One Cycle Surge Current, Non-Repetitive $T_j = 25C, V_r = 0$	60 Hz	I_{TSM}	50,890 A
	50 Hz	I_{TSM}	46,400 A
Peak One Cycle Surge Current, Non-Repetitive $T_j = 25C, V_r = V_{rrm}$	60 Hz	I_{TSM}	33,925 A
	50 Hz	I_{TSM}	30,935 A
Peak One Cycle Surge Current, Non-Repetitive $T_j = 125C, V_r = 0$	60 Hz	I_{TSM}	44,250 A
	50 Hz	I_{TSM}	40,350 A
Peak One Cycle Surge Current, Non-Repetitive $T_j = 125C, V_r = V_{rrm}$	60 Hz	I_{TSM}	29,500 A
	50 Hz	I_{TSM}	26,900 A
Peak Three Cycle Surge Current, Non-Repetitive	60 Hz, $T_j = 125C, V_r = V_{rrm}$	I_{TSM}	23,690 A
Peak Ten Cycle Surge Current, Non-Repetitive	60 Hz, $T_j = 125C, V_r = V_{rrm}$	I_{TSM}	18,615 A
I^2t for Fusing for One Cycle $T_j = 125C, V_r = V_{rrm}$	8.3 milliseconds	I^2t	3.63×10^6 A ² sec
	10 milliseconds	I^2t	3.62×10^6 A ² sec
Maximum Rate-of-Rise of On-State Current, (Non-Repetitive)	Per JEDEC Standard 397 5.2.2.6	di/dt	400 A/ μ s
Maximum Rate-of-Rise of On-State Current, (Repetitive)	Per JEDEC Standard 397 5.2.2.6	di/dt	150 A/ μ s
Operating Temperature		T_j	-40 to +125 °C
Storage Temperature		T_{stg}	-40 to +150 °C
Max. Mounting Torque, M6 Mounting Screw			132 in. – Lb.
			15 Nm
Max. Mounting Torque, M10 Terminal Screw			106 in. – Lb.
			12 Nm
Module Weight, Typical			455 g
			11.75 lb
V Isolation @ 25C		V_{rms}	3000 V

Powerex, Inc., Hillis Street, Youngwood, Pennsylvania 15697 (724) 925-7272

POW-R-BLOK™
Dual SCR Isolated Module
600 Amperes / Up to 2400 Volts

Electrical Characteristics, T_J=25° C unless otherwise specified

Characteristics	Symbol	Test Conditions	Min.	Max.	Units
Repetitive Peak Forward Leakage Current	I _{DRM}	Up to 2400V, T _J =125° C		100	mA
Repetitive Peak Reverse Leakage Current	I _{RDM}	Up to 2400V, T _J =125° C		100	mA
Peak On-State Voltage	V _{TM}	I _{TM} =3000A, T _J =125° C		1.75	V
Threshold Voltage, Low-level	V _{(TO)1}	T _J = 125° C, I = 15%I _{T(AV)} to πI _{T(AV)}		0.869	V
Slope Resistance, Low-level	r _{T1}			0.237	mΩ
Threshold Voltage, High-level	V _{(TO)2}	T _J = 125° C, I = πI _{T(AV)} to I _{TSM}		1.055	V
Slope Resistance, High-level	r _{T2}			0.175	mΩ
V _{TM} Coefficients, Full Range		T _J = 125° C, I = 50A to 6kA V _{TM} = A + B Ln I + C I + D Sqrt I	A = B = C = D =	0.93159 -4.51 E-02 9.95 E-05 1.29 E-02	
Minimum dV/dt	dV/dt	Exponential to 0.67V _{DRM} T _J =125° C, Gate Open	600		V/μs
Gate Trigger Current	I _{GT}	T _J =25° C, V _D =12V		200	mA
Gate Trigger Voltage	V _{GT}	T _J =25° C, V _D =12V		3.0	Volts
Non-Triggering Gate Voltage	V _{GDM}	T _J =125° C, V _D = ½ V _{DRM}		0.15	Volts
Holding Current	I _H			300	mA
Peak Forward Gate Current	I _{GMT}			4.0	Amp
Peak Reverse Gate Voltage	V _{GRM}			5	Volts
Maximum Average Gate Power Dissipation	P _{GM(AVE)}			16	Watts

Thermal Characteristics

Characteristics	Symbol	Test Conditions	Max.	Units
Thermal Resistance, Junction to Case	R _{θJ-C}	Per Module, both conducting Per Junction, both conducting	0.029 0.058	°C/W °C/W
Thermal Impedance Coefficients	Z _{θJ-C}	Z _{θJ-C} = K ₁ (1-exp(-t/τ ₁)) + K ₂ (1-exp(-t/τ ₂)) + K ₃ (1-exp(-t/τ ₃)) + K ₄ (1-exp(-t/τ ₄))	K ₁ = 5.04 E-04 K ₂ = 2.31 E-03 K ₃ = 2.83 E-03 K ₄ = 5.24 E-02	τ ₁ = 2.47 E-03 τ ₂ = 4.42 E-02 τ ₃ = 1.370 τ ₄ = 9.668
Thermal Resistance, Case to Sink Lubricated	R _{θC-S}	Per Module	0.009	°C/W

Powerex, Inc., Hillis Street, Youngwood, Pennsylvania 15697 (724) 925-7272

Dual SCR Module 600 Amperes / Up to 2400 Volts

Typical On-State Forward Voltage Drop
($T_j = 125^\circ\text{C}$)

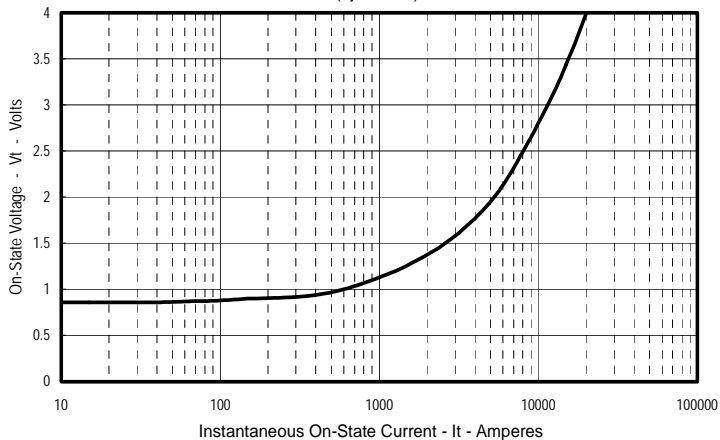

Maximum Transient Thermal Impedance
(Junction To Case)

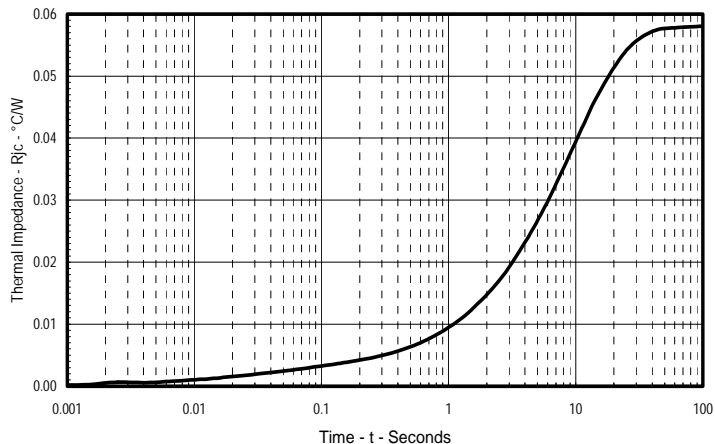

Maximum On-State Power Dissipation
(Sinusoidal Waveform)

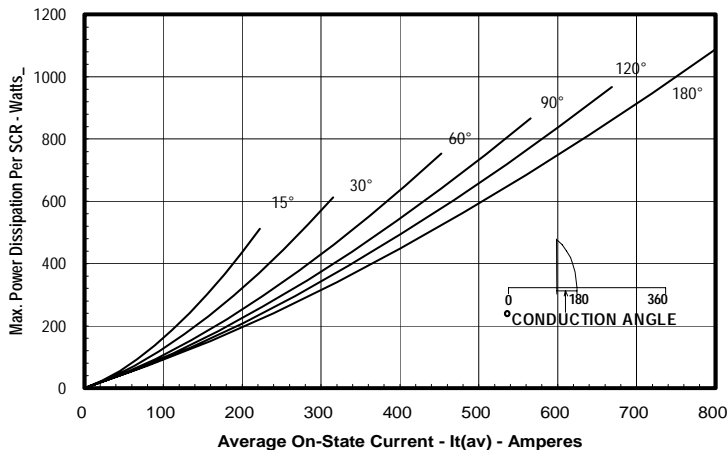

Maximum Allowable Case Temperature
(Sinusoidal Waveform)

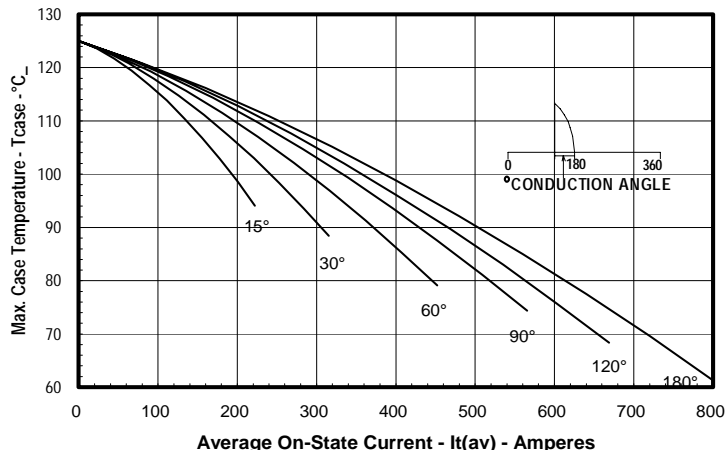

Maximum On-State Power Dissipation
(Rectangular Waveform)

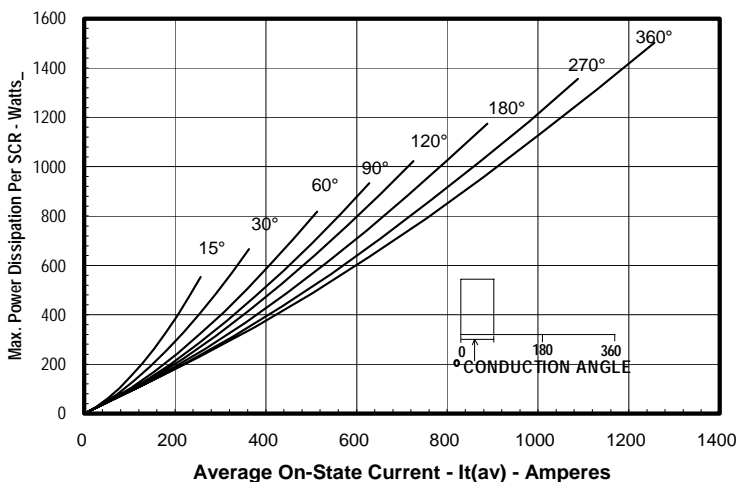

Maximum Allowable Case Temperature
(Rectangular Waveform)

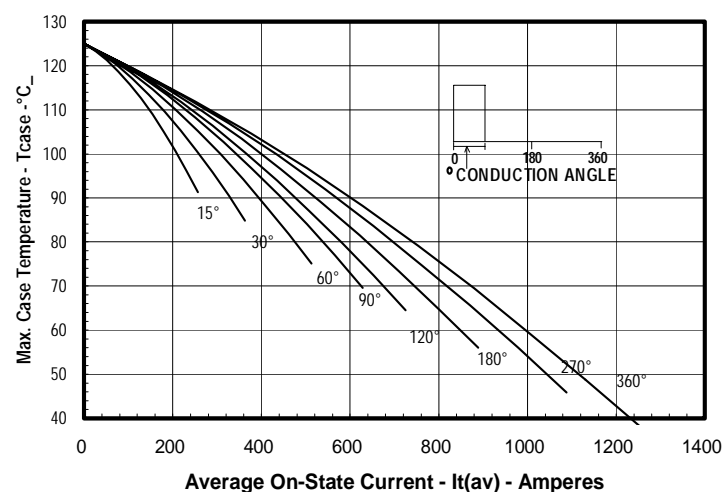

Powerex, Inc., Hillis Street, Youngwood, Pennsylvania 15697 (724) 925-7272

Dual SCR Module
600 Amperes / Up to 2400 Volts

DIM.	INCHES	MILLIMETERS
A	7.80	198.1
B	4.00	101.6
C	2.68	68.1
D	6.44	163.6
E	3.44	87.4
F	.28	7.1
G	7.31	185.7
H	7.00	177.8
J	1.65	42
K	.21	5.3
L	.28	7.1
M	.281	7.1
N	.45	11.4
P	.54	13.7
Q	5.93	150.6
R	.19	4.8
S	.11	2.8
T	.48	12.2
U	2.28	58
V	2.54	64.5
W	4.93	125.2
X	3.81	96.8
Y	.03	.8
Z	2.00	50.8
AA	1.00	25.4
BB	.50	12.7
CC	1.00	25.4
DD	.406	10.3
EE	2.87	72.9
FF	.66	16.8

