

FRD

100A Avg 200 Volts

PC100F2
PD100F2

回路図 CIRCUIT

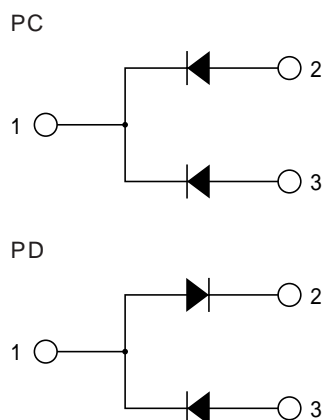

外形寸法図 OUTLINE DRAWING (単位 Dimension : mm)

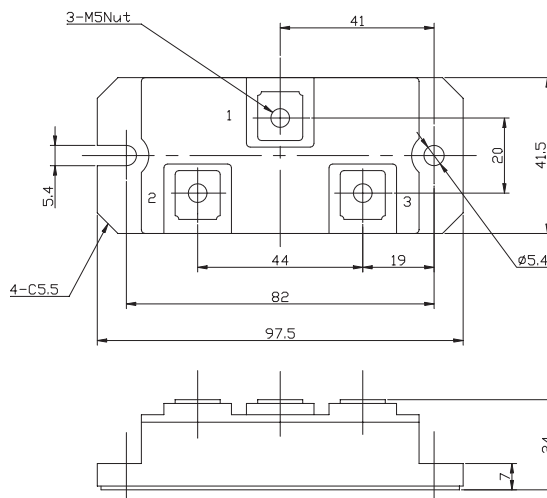

最大定格 Maximum Ratings

項目 Parameter	記号 Symbol	耐圧クラス Grade		単位 Unit
		PC100F2/PD100F2		
くり返しピーク逆電圧 Repetitive Peak Reverse Voltage	*1 V _{RRM}	200		V
非くり返しピーク逆電圧 Non Repetitive Peak Reverse Voltage	*1 V _{RSM}	220		V

項目 Parameter	記号 Symbol	条件 Conditions	定格値 Max. Rated Value	単位 Unit	
平均整流電流 Average Rectified Output Current	*1 I _{o(AV)}	商用周波数 180° 通電 Half Sine Wave T _c = 99	100	A	
実効順電流 RMS Forward Current	*1 I _{F(RMS)}		157	A	
サージ順電流 Surge Forward Current	*1 I _{FSM}	50Hz正弦半波, 1 サイクル, 非くり返し Half Sine Wave, 1Pulse, Non-Repetitive	1800	A	
電流二乗時間積 I Squared t	*1 I ² t	2 ~ 10ms	16200	A ² s	
動作接合温度範囲 Operating Junction Temperature Range	T _{jw}		- 40 ~ + 150		
保存温度範囲 Storage Temperature Range	T _{stg}		- 40 ~ + 125		
絶縁耐圧 Isolation Voltage	V _{iso}	端子 - ベース間, AC 1 分間 Terminal to Base, AC 1 min.	2000	V	
締付トルク Mounting Torque	ベース部 Mounting 主端子部 Terminal	サーマルコンパウンド塗布 Greased	M5	2.4 ~ 2.8	N·m
			M5	2.4 ~ 2.8	N·m

電気的特性 Electrical Characteristics

項目 Parameter	記号 Symbol	条件 Conditions	特性値 (最大) Maximum Value	単位 Unit
ピーク逆電流 Peak Reverse Current	*1 I _{RM}	T _j =150 , V _{RM} =V _{RRM}	10	mA
ピーク順電圧 Peak Forward Voltage	*1 V _{FM}	T _j =25 , I _{FM} =100A	1.00	V
逆回復時間 Reverse Recovery Time	*1 t _{rr}	T _j =25 , I _{FM} =10A , - di/dt = 50A/μs	90	ns
熱抵抗 Thermal Resistance	*1 R _{th(j-c)}	接合部 - ケース間 Junction to Case	0.5	/W
接触熱抵抗 Thermal Resistance	R _{th(c-f)}	ケース - フィン間 (トータル), サーマルコンパウンド塗布 Case to Fin, Total, Greased	0.1	/W
内部リーディングインダクタンス Internal Inductance	L _s	アノード端子 - カソード端子間 Anode Terminal to Cathode Terminal	30	nH

質量...約205g
Approximate Weight

*1 : 1 アーム当りの値 Value Per 1 Arm.

定格・特性曲線

順電圧特性
FORWARD CURRENT VS. VOLTAGE

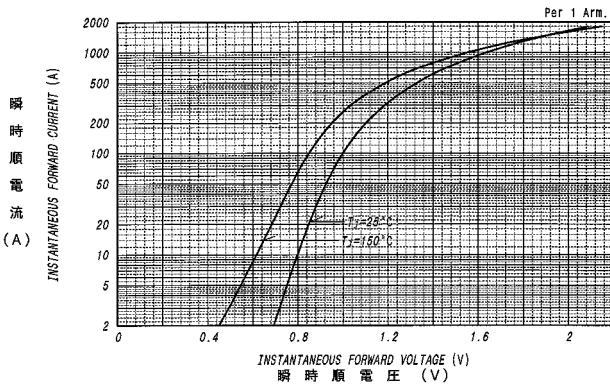

過渡熱抵抗特性
MAXIMUM TRANSIENT THERMAL IMPEDANCE
Junction to Case

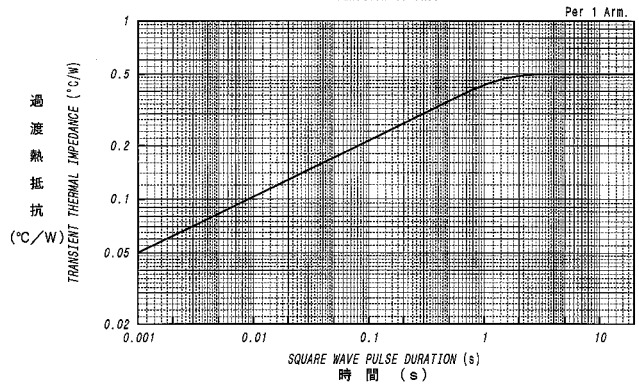

平均順電力損失特性
AVERAGE FORWARD POWER DISSIPATION

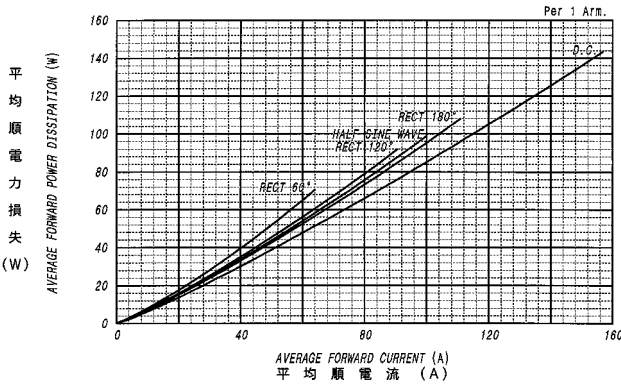

平均順電流 - ケース温度定格
AVERAGE FORWARD CURRENT VS. CASE TEMPERATURE

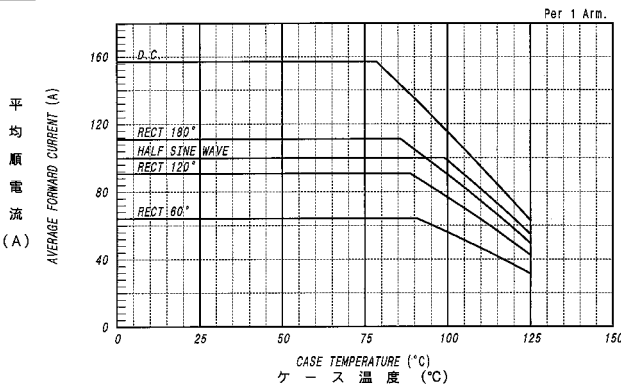

サージ順電流定格
SURGE CURRENT RATINGS

f=60Hz, Half Sine Wave, Non-Repetitive, Tj=150°C

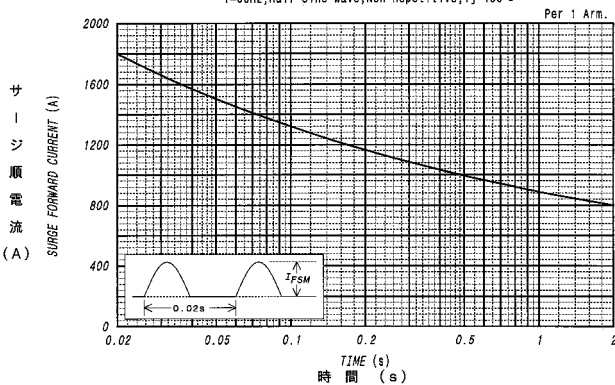

逆回復特性 (代表例)
REVERSE RECOVERY CHARACTERISTICS (TYP)

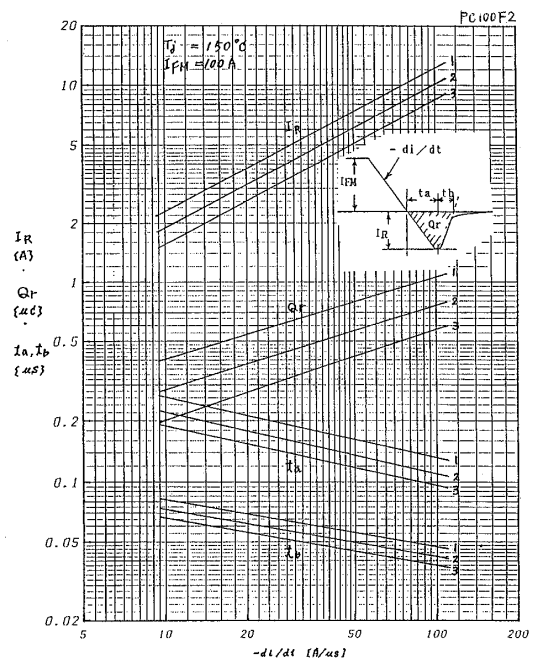

逆回復特性 (代表例)
REVERSE RECOVERY CHARACTERISTICS (TYP)

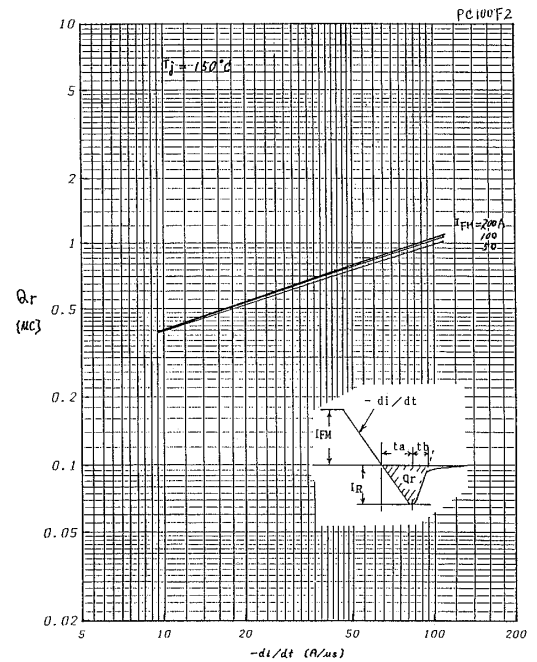

FRD・SBDモジュール