

# THYRISTOR MODULE

PCH15012 PCH15016

150A / 1200 to 1600V

## FEATURES

- \* Isolated Base
- \* Thyristor and Diode Cathode Common Circuit
- \* High Surge Capability
- \* UL Recognized, File No. E187184

## TYPICAL APPLICATIONS

- \* Rectified For General Use

## OUTLINE DRAWING

PCH

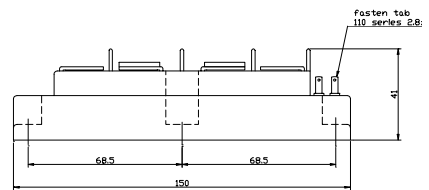
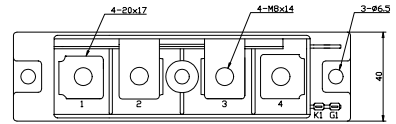
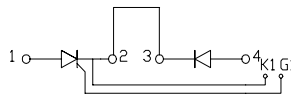

## Maximum Ratings

Approx Net Weight:480g

Parameter	Symbol	Grade		Unit
		PCH15012	PCH15016	
Repetitive Peak Off-State Voltage	$V_{DRM}$	1200	1600	V
Non Repetitive Peak Off-State Voltage	$V_{DSM}$	1300	1700	V
Repetitive Peak Reverse Voltage	$V_{RRM}$	1200	1600	V
Non Repetitive Peak Reverse Voltage	$V_{RSM}$	1300	1700	V

Parameter		Conditions	Max Rated Value	Unit	
Average Rectified Output Current	$I_{O(AV)}$	50Hz Half Sine Wave condition $T_c=73^\circ\text{C}$	150	A	
RMS On-State Current	$I_{T(RMS)}$		235	A	
Surge On-State Current	$I_{TSM}$	50 Hz Half Sine Wave, 1Pulse Non-Repetitive	3200	A	
I Squared t	$I^2t$	2msec to 10msec	51200	$\text{A}^2\text{s}$	
Critical Rate of Turned-On Current	$di/dt$	$V_D=2/3V_{DRM}$ , $I_{TM}=2 \cdot I_o$ , $T_j=125^\circ\text{C}$ $I_G=300\text{mA}$ , $di_G/dt=0.2\text{A}/\mu\text{s}$	100	$\text{A}/\mu\text{s}$	
Peak Gate Power	$P_{GM}$		5	W	
Average Gate Power	$P_{G(AV)}$		1	W	
Peak Gate Current	$I_{GM}$		2	A	
Peak Gate Voltage	$V_{GM}$		10	V	
Peak Gate Reverse Voltage	$V_{RGM}$		5	V	
Operating Junction Temperature Range	$T_{jw}$		-40 to +125	$^\circ\text{C}$	
Storage Temperature Range	$T_{stg}$		-40 to +125	$^\circ\text{C}$	
Isolation Voltage	Viso	Base Plate to Terminals, AC1min	2500	V	
Mounting torque	Case mounting	Ftor	M6 Screw	2.5 to 3.5	N.m
	Terminals		M8 Screw	9.0 to 10.0	

Value per 1 Arm

**Electrical • Thermal Characteristics**

Characteristics	Symbol	Test Conditions	Maximum Value.			Unit
			Min.	Typ.	Max.	
Peak Off-State Current	$I_{DM}$	$V_{DM} = V_{DRM}, T_j = 125^\circ\text{C}$			50	mA
Peak Reverse Current	$I_{RM}$	$V_{RM} = V_{RRM}, T_j = 125^\circ\text{C}$			50	mA
Peak Forward Voltage	$V_{TM}$	$I_{TM} = 450\text{A}, T_j = 25^\circ\text{C}$			1.38	V
Gate Current to Trigger	$I_{GT}$	$V_D = 6\text{V}, I_T = 1\text{A}$	$T_j = -40^\circ\text{C}$		300	mA
			$T_j = 25^\circ\text{C}$		150	
			$T_j = 125^\circ\text{C}$		80	
Gate Voltage to Trigger	$V_{GT}$	$V_D = 6\text{V}, I_T = 1\text{A}$	$T_j = -40^\circ\text{C}$		5	V
			$T_j = 25^\circ\text{C}$		3	
			$T_j = 125^\circ\text{C}$		2	
Gate Non-Trigger Voltage	$V_{GD}$	$V_D = 2/3V_{DRM}, T_j = 125^\circ\text{C}$	0.25			V
Critical Rate of Rise of Off-State Voltage	dv/dt	$V_D = 2/3V_{DRM}, T_j = 125^\circ\text{C}$	500			V/ $\mu\text{s}$
Turn-Off Time	tq	$I_{TM} = I_O, V_D = 2/3V_{DRM}$ $dv/dt = 20\text{V}/\mu\text{s}, V_R = 100\text{V}$ $-di/dt = 20\text{A}/\mu\text{s}, T_j = 125^\circ\text{C}$		100		$\mu\text{s}$
Turn-On Time	tgt	$V_D = 2/3V_{DRM}, T_j = 125^\circ\text{C}$ $I_G = 300\text{mA}, di_G/dt = 0.2\text{A}/\mu\text{s}$		6		$\mu\text{s}$
Delay Time	td			2		$\mu\text{s}$
Rise Time	tr			4		$\mu\text{s}$
Latching Current	$I_L$	$T_j = 25^\circ\text{C}$		150		mA
Holding Current	$I_H$	$T_j = 25^\circ\text{C}$		100		
Thermal Resistance	Rth(j-c)	Junction to Case			0.25	$^\circ\text{C}/\text{W}$
	Rth(c-f)	Base Plate to Heat Sink with Thermal Compound			0.1	

Value Per 1Arm

PCH1501x OUTLINE DRAWING (Dimensions in mm)

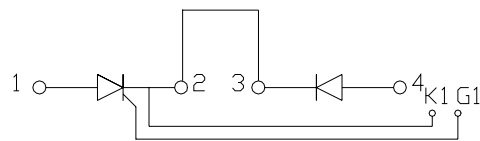
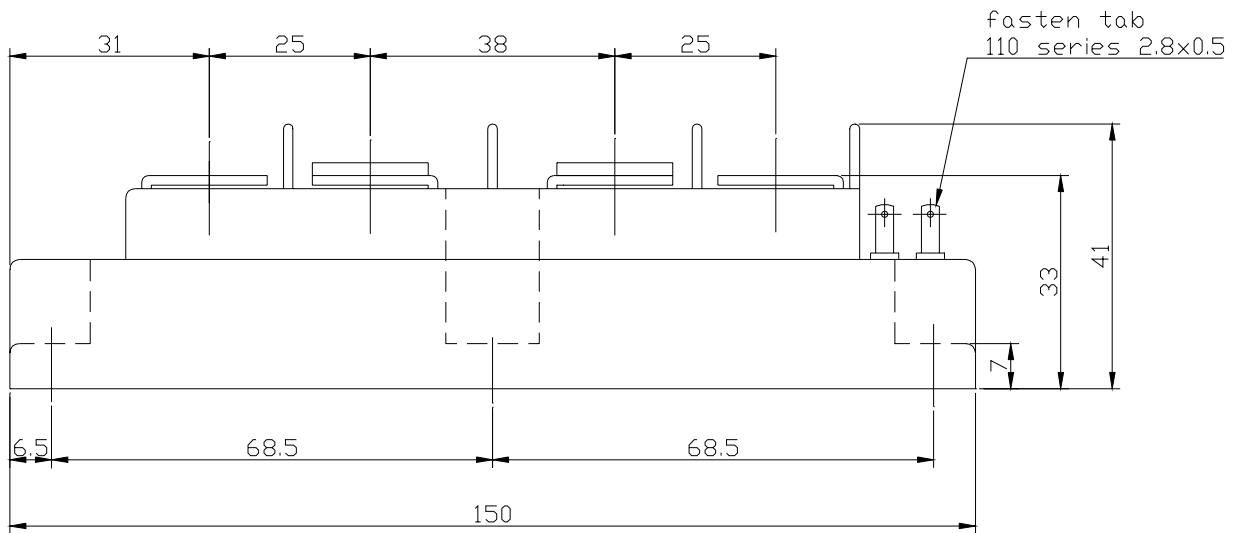
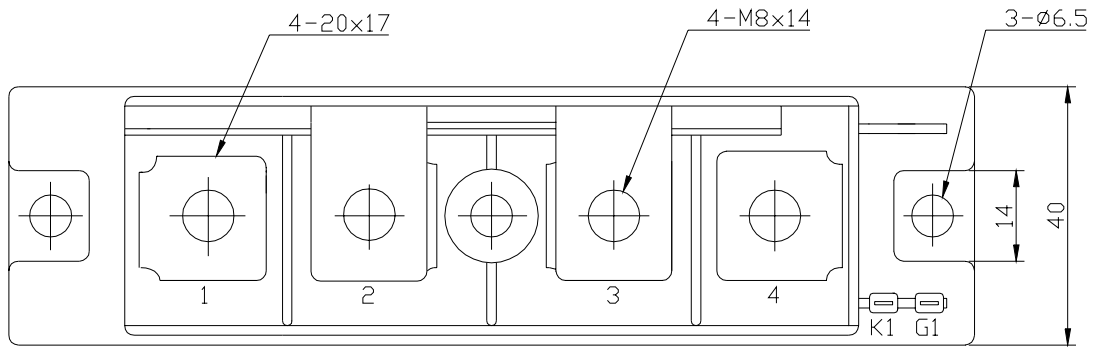

オン電圧特性  
ON-STATE CURRENT VS. VOLTAGE

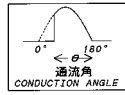
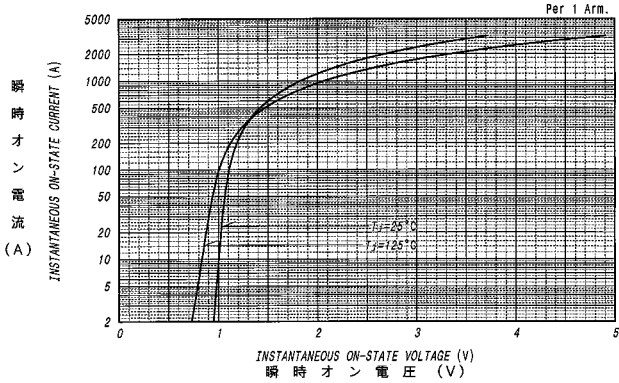

平均オン電力損失特性  
AVERAGE ON-STATE POWER DISSIPATION

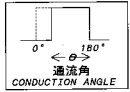
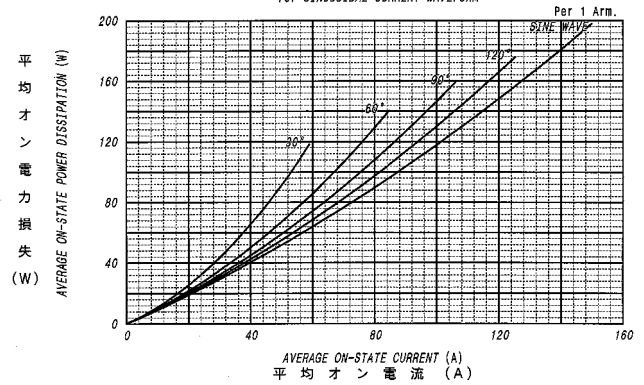

平均オン電力損失特性  
AVERAGE ON-STATE POWER DISSIPATION

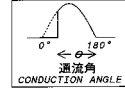
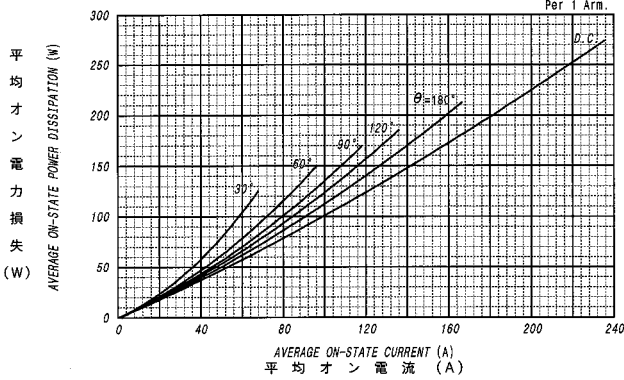

平均オン電流 - ケース温度定格  
AVERAGE ON-STATE CURRENT VS. CASE TEMPERATURE

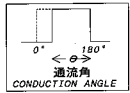
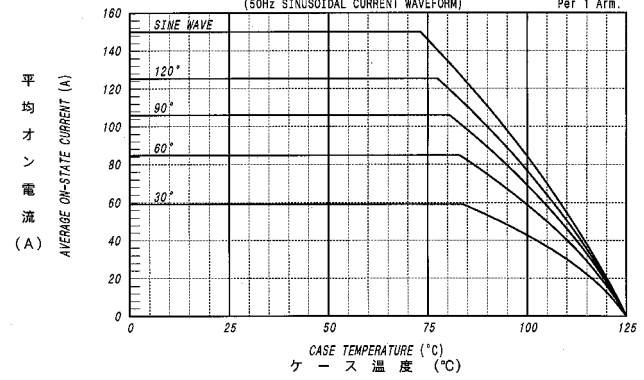

平均オン電流 - ケース温度定格  
AVERAGE ON-STATE CURRENT VS. CASE TEMPERATURE

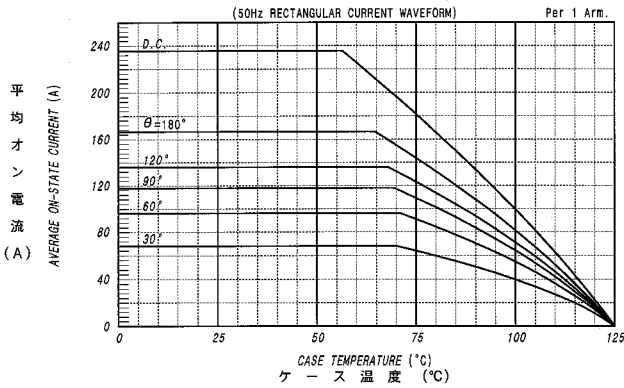

サージオン電流定格  
SURGE CURRENT RATINGS

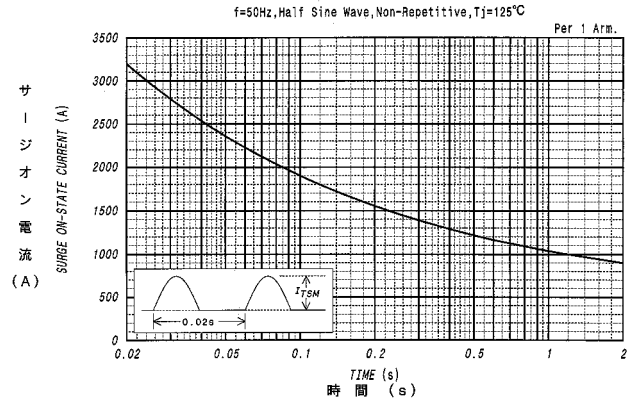

ゲート特性  
GATE CHARACTERISTICS

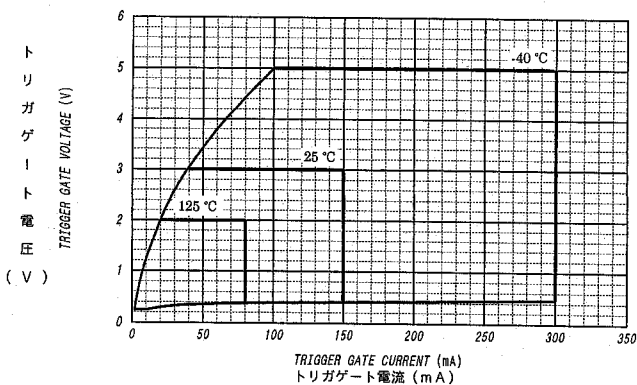

ゲート定格  
GATE RATINGS

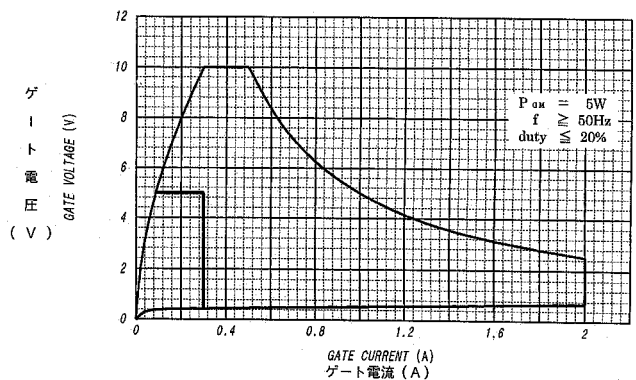

過渡熱抵抗特性  
MAXIMUM TRANSIENT THERMAL IMPEDANCE

Junction to Case

Per 1 Arm.

