

PAF SERIES

DC/DC Module 450W-700W



Features

- Full brick industry standard size (61×12.7×116.8mm)
- High power density (industry-leading level in PAF700-F48)
- Broad range of baseplate operating temperatures: -40 to +100C
- High efficiency: 91% max (PAF700F48/PAF450F280/PAF600F280)
- Wide variety of functions
Remote sensing (+S/-S), ON/OFF control (CNT), Output voltage trimming (TRM), Inverter operation monitoring (IOG), Parallel control (PC), Auxiliary power supply (AUX), Over voltage protection (OVP), Over current protection (OCP)
- Internal capacitor: Ceramic capacitor only (high reliability)

Applications



Model naming method

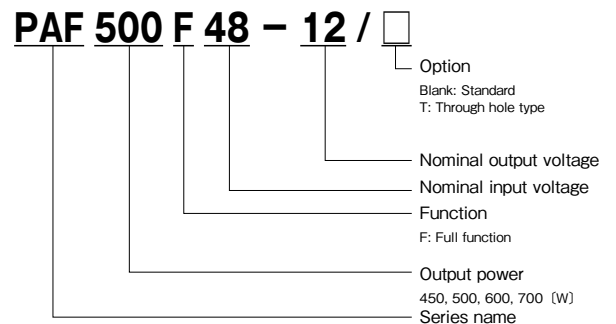

Conformity to RoHS Directive

This means that, in conformity with EU Directive 2002/95/EC, lead, cadmium, mercury, hexavalent chromium, and specific bromine-based flame retardants, PBB and PBDE, have not been used, except for exempted applications.

Product Line up

PAF-F24 (DC24Vin)

Output Voltage	500W		600W	
	Output Current	Model	Output Current	Model
3.3V	—	—	—	—
5V	—	—	—	—
12V	42A	PAF500F24-12	50A	PAF600F24-12
28V	18A	PAF500F24-28	21.5A	PAF600F24-28

PAF-F48 (DC48Vin)

Output Voltage	500W		600W		700W	
	Output Current	Model	Output Current	Model	Output Current	Model
80A	PAF500F48-3.3	—	—	—	—	—
80A	PAF500F48-5	—	—	—	—	—
42A	PAF500F48-12	50A	PAF600F48-12	58.5A	PAF700F48-12	
18A	PAF500F48-28	21.5A	PAF600F48-28	25A	PAF700F48-28	

PAF-F280 (DC280Vin)

Output Voltage	450W		600W	
	Output Current	Model	Output Current	Model
12V	38A	PAF450F280-12	50A	PAF600F280-12
24V	19A	PAF450F280-24	25A	PAF600F280-24
28V	16.5A	PAF450F280-28	21.5A	PAF600F280-28
48V	9.5A	PAF450F280-48	12.5A	PAF600F280-48

Note) The pin configuration differs depending on the product. Refer to the appearance diagram for detail.

web170720

PAF500F24 Specifications

ITEMS/UNITS		MODEL	PAF500F24-12	PAF500F24-28
Input	Voltage Range	V	DC19 - 36	DC18 - 36
	Efficiency (typ)	(*1) %	89	90
	Current (typ)	(*2) A	24	23.8
Output	Nominal Voltage	VDC	12	28
	Maximum Current	A	42	18
	Maximum Power	W	504	
	Voltage Setting Accuracy	(*2) %	±1	
	Maximum Line Regulation	(*3) mV	24	56
	Maximum Load Regulation	(*4) mV	24	56
	Temperature Coefficient		0.02%/°C	
	Maximum Ripple & Noise	(*10) mVp-p	200	280
	Voltage Adjustable Range	(*10)	-40%, +10%	
	Function	Over Current Protection	(*5)	105% - 140%
Over Voltage Protection		(*6)	115% - 135%	
Remote Sensing		(*9)	Possible	
Remote ON/OFF Control		(*9)	Possible (SHORT: ON OPEN: OFF)	
Parallel Operation		(*9)	Possible	
Series Operation		(*9)	Possible	
I.O.G. Signal		(*9)	Possible (Open collector output)	
Environment		Operating Temperature	(*7) °C	-40 to +100 (Baseplate) Ambient Temperature min=-40
	Storage Temperature	°C	-40 to +100	
	Operating Humidity	%RH	20 - 95 (No dewdrop)	
	Storage Humidity	%RH	10 - 95 (No dewdrop)	
	Vibration		At no operating, 10-55Hz (sweep for 1min.) Amplitude 0.825mm constant (maximum 49.0m/s ²) X, Y, Z 1 Hour each	
	Shock		196.1m/s ²	
	Cooling	(*8)	Conduction cooled	
Isolation	Withstand Voltage		Input-Baseplate : 1.5kVDC, Input-Output : 1.5kVDC for 1min. Output-Baseplate : 500VDC for 1min.	
	Isolation Resistance		More than 100MΩ at 25°C and 70%RH Output-Baseplate...500VDC	
Standards	Safety Standards		Approved by UL60950-1, CSA C22.2 No.60950-1, EN60950-1	
Mechanical	Weight (typ)	g	250	
	Size (W x H x D)	mm	61 x 12.7 x 116.8 (Refer to outline drawing)	

PAF

- (*1) At 24VDC, 80% of maximum output current and baseplate temperature = +25°C .
- (*2) At 24VDC and maximum output current.
- (*3) 19 - 36VDC, constant load. (PAF500F24-12)
18 - 36VDC, constant load. (PAF500F24-28)
- (*4) No load - full load, constant input voltage.
- (*5) Constant current limiting with automatic recovery.
- (*6) Inverter shutdown method, manual reset.
- (*7) Ratings - Refer to derating curve below.
- Load(%) is percent of maximum output current.
- (*8) Heatsink has to be chosen according to instruction manual.
- (*9) Refer to instruction manual.
- (*10) External components are needed for operation.
(Refer to basic connection and instruction manual.)

Output Derating

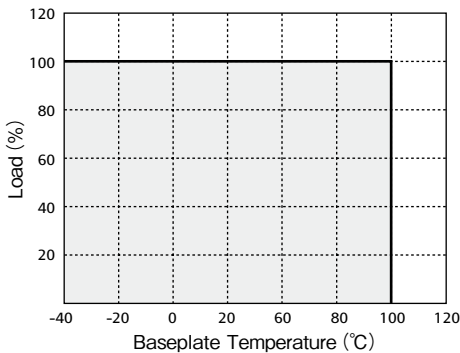

● Outline Drawing • Basic Connection B-99Page

PAF600F24 Specifications

ITEMS/UNITS		MODEL	PAF600F24-12	PAF600F24-28
Input	Voltage Range	V	DC20 - 36	
	Efficiency (typ)	(*1) %	89	
	Current (typ)	(*2) A	28.9	
Output	Nominal Voltage	VDC	12	28
	Maximum Current	A	50	21.5
	Maximum Power	W	600	602
	Voltage Setting Accuracy	(*2) %	±1	
	Maximum Line Regulation	(*3) mV	24	56
	Maximum Load Regulation	(*4) mV	24	56
	Temperature Coefficient		0.02%/°C	
	Maximum Ripple & Noise	(*10) mVp-p	200	280
	Voltage Adjustable Range	(*10)	-40%, +10%	
	Function	Over Current Protection	(*5)	105% - 140%
Over Voltage Protection		(*6)	115% - 135%	
Remote Sensing		(*9)	Possible	
Remote ON/OFF Control		(*9)	Possible (SHORT: ON OPEN: OFF)	
Parallel Operation		(*9)	Possible	
Series Operation		(*9)	Possible	
I.O.G. Signal		(*9)	Possible (Open collector output)	
Environment	Operating Temperature	(*7) °C	-40 to +100 (Baseplate) Ambient Temperature min=-40	
	Storage Temperature	°C	-40 to +100	
	Operating Humidity	%RH	30 - 95 (No dewdrop)	
	Storage Humidity	%RH	10 - 95 (No dewdrop)	
	Vibration		At no operating, 10-55Hz (sweep for 1min.) Amplitude 0.825mm constant (maximum 49.0m/s ²) X, Y, Z 1 Hour each	
	Shock		196.1m/s ²	
	Cooling	(*8)	Conduction cooled	
Isolation	Withstand Voltage		Input-Baseplate : 1.5kVDC, Input-Output : 1.5kVDC for 1min. Output-Baseplate : 500VDC for 1min.	
	Isolation Resistance		More than 100MΩ at 25°C and 70%RH Output-Baseplate...500VDC	
Standards	Safety Standards		Approved by UL60950-1, CSA C22.2 No.60950-1, EN60950-1	
Mechanical	Weight (typ)	g	250	
	Size (W x H x D)	mm	61 x 12.7 x 116.8 (Refer to outline drawing)	

PAF

- (*1) At 24VDC, 80% of maximum output current and baseplate temperature = +25°C.
- (*2) At 24VDC and maximum output current.
- (*3) 20 - 36VDC, constant load. (PAF600F24-12)
19 - 36VDC, constant load. (PAF600F24-28)
- (*4) No load - full load, constant input voltage.
- (*5) Constant current limiting with automatic recovery.

- (*6) Inverter shutdown method, manual reset.
- (*7) Ratings - Refer to derating curve below.
- Load(%) is percent of maximum output current.
- (*8) Heatsink has to be chosen according to instruction manual.
- (*9) Refer to instruction manual.
- (*10) External components are needed for operation.
(Refer to basic connection and instruction manual.)

Output Derating

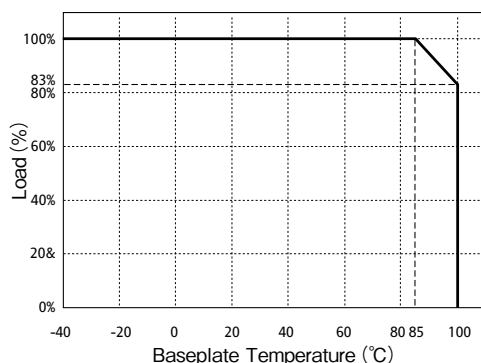

● Outline Drawing • Basic Connection **B-99**Page

PAF500F48 Specifications

ITEMS/UNITS		MODEL	PAF500F48-3.3	PAF500F48-5	PAF500F48-12	PAF500F48-28
Input	Voltage Range	V	DC36 - 76			
	Efficiency (typ)	(*1) %	78	83	89	90
	Current (typ)	(*2) A	7.3	10.4	12.2	12.1
Output	Nominal Voltage	VDC	3.3	5	12	28
	Maximum Current	A	80		42	18
	Maximum Power	W	264	400	504	
	Voltage Setting Accuracy	(*2) %	±1			
	Maximum Line Regulation	(*3) mV	10		24	56
	Maximum Load Regulation	(*4) mV	10		24	56
	Temperature Coefficient		0.02%/°C			
	Maximum Ripple & Noise	(*10) mVp-p	100		200	280
	Voltage Adjustable Range	(*10)	-40%, +20%		-40%, +10%	
	Over Current Protection	(*5)	105% - 140%			
Function	Over Voltage Protection	(*6)(*9)	130% - 160%	125% - 145%	115% - 135%	
	Remote Sensing	(*9)	Possible			
	Remote ON/OFF Control	(*9)	Possible (SHORT : ON OPEN : OFF)			
	Parallel Operation	(*9)	Possible			
	Series Operation	(*9)	Possible			
	I.O.G. Signal	(*9)	Possible (Open collector output)			
	Environment	Operating Temperature	(*7) °C	-40 to +100 (Baseplate) Ambient temperature min=-40		
Storage Temperature			-40 to +100			
Operating Humidity		%RH	20 - 95 (No dewdrop)			
Storage Humidity		%RH	10 - 95 (No dewdrop)			
Vibration			At no operating, 10-55Hz (sweep for 1min.) Amplitude 0.825mm constant (maximum 49.0m/s ²) X, Y, Z 1 Hour each			
Shock			196.1m/s ²			
Cooling		(*8)	Conduction cooled			
Isolation	Withstand Voltage		Input-Baseplate : 1.5kVDC, Input-Output : 1.5kVDC for 1min. Output-Baseplate : 500VDC for 1min.			
	Isolation Resistance		More than 100MΩ at 25°C and 70%RH Output-Baseplate...500VDC			
Standards	Safety Standards		Approved by UL60950-1, CSA C22.2 No.60950-1, EN60950-1			
Mechanical	Weight (typ)	g	250			
	Size (W x H x D)	mm	61 x 12.7 x 116.8 (Refer to outline drawing)			

PAF

- (*1) At 48VDC, 80% of maximum output current and baseplate temperature = +25°C .
- (*2) At 48VDC and maximum output current.
- (*3) 36 - 76VDC, constant load.
- (*4) No load - full load, constant input voltage.
- (*5) Constant current limiting with automatic recovery.
- (*6) Inverter shutdown method, manual reset.
- (*7) Ratings - Refer to derating curve below.
- Load(%) is percent of maximum output current.
- (*8) Heatsink has to be chosen according to instruction manual.
- (*9) Refer to instruction manual.
- (*10) External components are needed for operation.
(Refer to basic connection and instruction manual.)

Output Derating

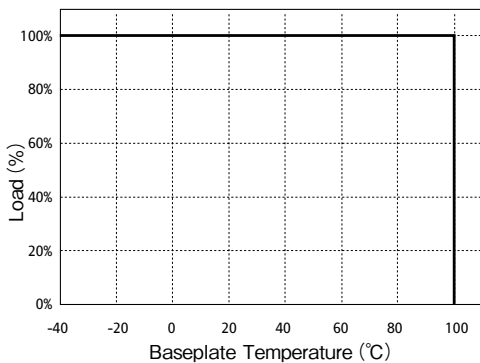

● Outline Drawing • Basic Connection B-99Page

PAF600F48 Specifications

ITEMS/UNITS		MODEL	PAF600F48-12	PAF600F48-28
Input	Voltage Range	V	DC36 - 76	
	Efficiency (typ)	(*1) %	89	90
	Current (typ)	(*2) A	14.2	14.1
Output	Nominal Voltage	VDC	12	28
	Maximum Current	A	50	21.5
	Maximum Power	W	600	602
	Voltage Setting Accuracy	(*2) %	±1	
	Maximum Line Regulation	(*3) mV	24	56
	Maximum Load Regulation	(*4) mV	24	56
	Temperature Coefficient		0.02%/°C	
	Maximum Ripple & Noise	(*10) mVp-p	200	280
	Voltage Adjustable Range	(*10)	-40%, +10%	
	Function	Over Current Protection	(*5)	105% - 140%
Over Voltage Protection		(*6)(*9)	115% - 135%	
Remote Sensing		(*9)	Possible	
Remote ON/OFF Control		(*9)	Possible (SHORT : ON OPEN : OFF)	
Parallel Operation		(*9)	Possible	
Series Operation		(*9)	Possible	
I.O.G. Signal		(*9)	Possible (Open collector output)	
Environment	Operating Temperature	(*7) °C	-40 to +100 (Baseplate) Ambient Temperature min=-40	
	Storage Temperature	°C	-40 to +100	
	Operating Humidity	%RH	20 - 95 (No dewdrop)	
	Storage Humidity	%RH	10 - 95 (No dewdrop)	
	Vibration		At no operating, 10-55Hz (sweep for 1min.) Amplitude 0.825mm constant (maximum 49.0m/s ²) X, Y, Z 1 Hour each	
	Shock		196.1m/s ²	
	Cooling	(*8)	Conduction cooled	
Isolation	Withstand Voltage		Input-Baseplate : 1.5kVDC, Input-Output : 1.5kVDC for 1min. Output-Baseplate : 500VDC for 1min.	
	Isolation Resistance		More than 100MΩ at 25°C and 70%RH Output-Baseplate...500VDC	
Standards	Safety Standards		Approved by UL60950-1, CSA C22.2 No.60950-1, EN60950-1	
Mechanical	Weight (typ)	g	250	
	Size (W x H x D)	mm	61 x 12.7 x 116.8 (Refer to outline drawing.)	

- (*1) At 48VDC, 80% of maximum output current and baseplate temperature = +25°C.
- (*2) At 48VDC and maximum output current.
- (*3) 36 - 76VDC, constant load.
- (*4) No load - full load, constant input voltage.
- (*5) Constant current limiting with automatic recovery.

- (*6) Inverter shutdown method, manual reset.
- (*7) Ratings - Refer to derating curve below.
- Load(%) is percent of maximum output current.
- (*8) Heatsink has to be chosen according to instruction manual.
- (*9) Refer to instruction manual.
- (*10) External components are needed for operation.
(Refer to basic connection and instruction manual.)

PAF

Output Derating

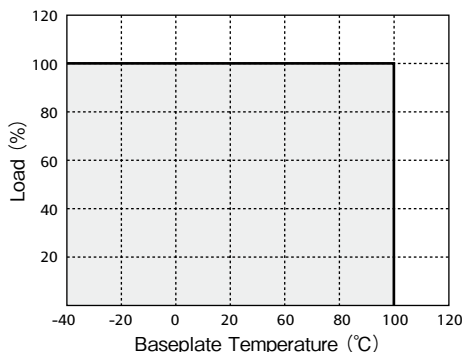

●Outline Drawing●Basic Connection B-99Page

PAF700F48 Specifications

ITEMS/UNITS		MODEL	PAF700F48-12	PAF700F48-28
Input	Voltage Range	V	DC36 - 76	
	Efficiency (typ)	(*1) %	90	91
	Current (typ)	(*2) A	16.5	16.4
Output	Nominal Voltage	VDC	12	28
	Maximum Current	A	58.5	25
	Maximum Power	W	702	700
	Voltage Setting Accuracy	(*2) %	±1	
	Maximum Line Regulation	(*3) mV	24	56
	Maximum Load Regulation	(*4) mV	24	56
	Temperature Coefficient		0.02%/°C	
	Maximum Ripple & Noise	(*10) mVp-p	200	280
	Voltage Adjustable Range	(*10)	-40%, +15%	
	Function	Over Current Protection	(*5)	105% - 140%
Over Voltage Protection		(*6)(*9)	120% - 135%	
Remote Sensing		(*9)	Possible	
Remote ON/OFF Control		(*9)	Possible (SHORT : ON OPEN : OFF)	
Parallel Operation		(*9)	Possible	
Series Operation		(*9)	Possible	
I.O.G. Signal		(*9)	Possible (Open collector output)	
Environment		Operating Temperature	(*7) °C	-40 to +100 (Baseplate) Ambient temperature min=-40
	Storage Temperature	°C	-40 to +100	
	Operating Humidity	%RH	20 - 95 (No dewdrop)	
	Storage Humidity	%RH	10 - 95 (No dewdrop)	
	Vibration		At no operating, 10 - 55Hz (sweep for 1min.) Amplitude 0.825mm constant (maximum 49.0m/s ²) X, Y, Z 1 hour each	
	Shock		196.1m/s ²	
Isolation	Withstand Voltage		Input-Baseplate : 1.5kVDC, Input-Output : 1.5kVDC for 1min. Output-Baseplate : 500VDC for 1min.	
	Isolation Resistance		More than 100MΩ at 25°C and 70%RH Output-Baseplate...500VDC	
Standards	Safety Standards		Approved by UL60950-1, CSA C22.2 No.60950-1, EN60950-1	
Mechanical	Weight (typ)	g	200	
	Size (W x H x D)	mm	61 x 12.7 x 116.8 (Refer to outline drawing)	

PAF

(*1) At 48VDC, 80% of maximum output current and baseplate temperature = +25°C.

(*2) At 48VDC and maximum output current.

(*3) 36 - 76VDC, constant load.

(*4) No load - full load, constant input voltage.

(*5) Constant current limiting with automatic recovery.

(*6) Inverter shutdown method, manual reset.

(*7) Ratings - Refer to derating curve below.
- Load(%) is percent of maximum output current.

(*8) Heatsink has to be chosen according to instruction manual.

(*9) Refer to instruction manual.

(*10) External components are needed for operation.
(Refer to basic connection and instruction manual.)

Output Derating

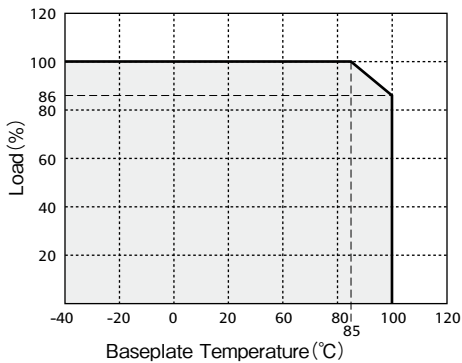

● Outline Drawing ● Basic Connection B-99Page

Outline Drawing

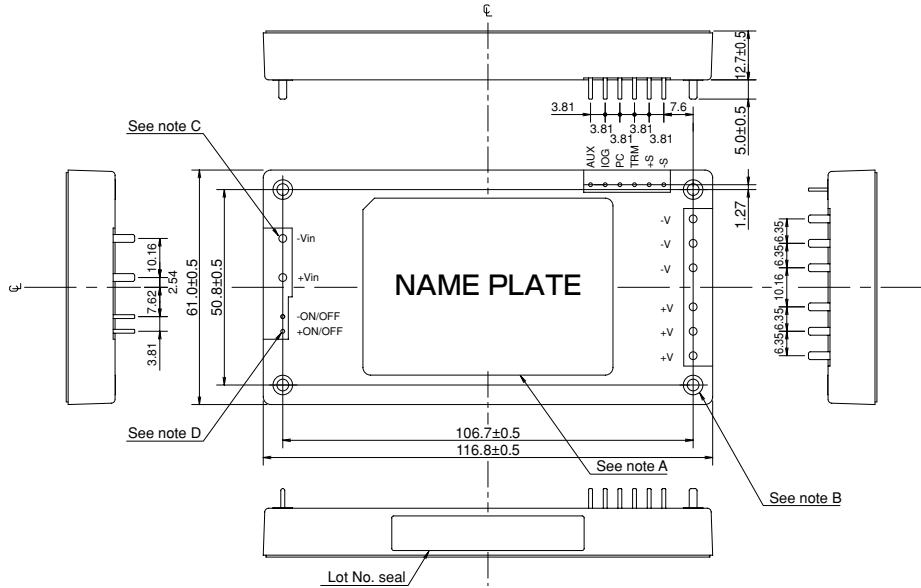

- NOTES : (unit : mm)
- A: Model name, input voltage range, nominal output voltage, maximum output current, country of manufacture and safety marking (C-UL-US, BSI & CE marking) are shown here in accordance with the specifications.
 - B: M3 tapped holes 4 for customer chassis mounting (FG).
 - C: Input and output terminal : 8-Φ2
 - D: Signal pin : 8-Φ1
 - E: Unless otherwise specified dimensional tolerance : ±0.3

Basic connection

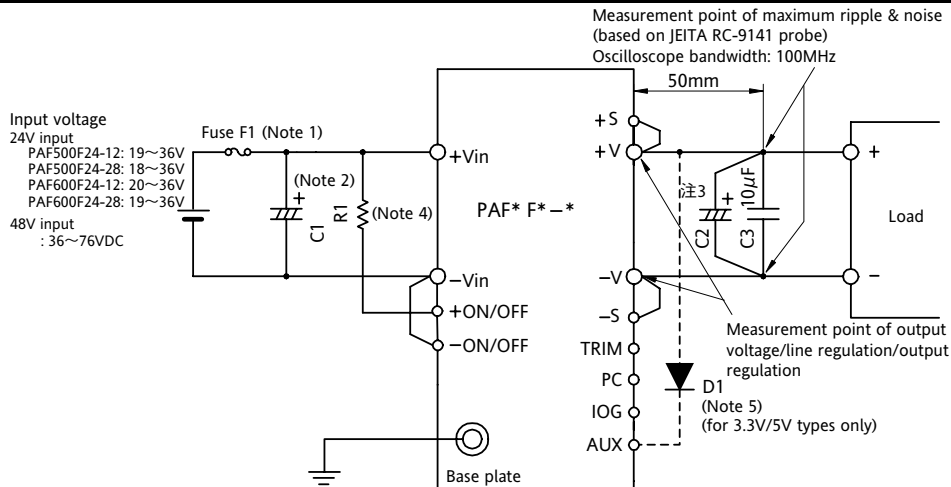

Note 1: The PAF series is not equipped with a fuse. Be sure to set a fast-blow fuse for the enhancement of safety and to get approval for safety standards. When using multiple units of the PAF series, set a fuse for each unit.

24V input: F1, 50A 48V input: F1, 30A

Note 2: Capacitor C1

Connect a low-impedance electrolytic capacitor C1 with the same or upper specifications shown in the table below, in order to reduce the effect of input line. Capacity of capacitor C1

Input	Operating temperature	
	-20° C - +100C	-40° C - +100C
PAF500/600F, 24V input	560µF x 2 units in parallel	560µF x 4 units in parallel
PAF500/600F, 48V input	100µF	100µF x 2 units in parallel
PAF700F48	220µF x 2 units in parallel	220µF x 2 units in parallel

Note 3: Capacitor C2

Connect a low-impedance electrolytic capacitor C2.

Input	Output voltage			
	3.3V	5V	12V	28V
24V input model	-	-	470µF 2 units in parallel	220µF 2 units in parallel
48V input model	5600µF 2 units in parallel	5600µF 2 units in parallel	470µF	220µF

When the 12V input types are used in a -20° C or lower ambient temperature, connect the following number of capacitors (in parallel).

PAF500F (500W): Two times the number in the table above PAF600F (600W): Three times the number in the table above

PAF700F (700W): Four times the number in the table above

Note 4: Resistance R1

24V input: 15kΩ (1/4W) 48V input: 30kΩ (1/2W)

Note 5: Diode D1

Connect a diode D1 (50V, 100mA) for 3.3V/5V types only.

• All specifications are subject to change without notice.

PAF450F280 Specifications

ITEMS/UNITS		MODEL	PAF450F280-12	PAF450F280-24	PAF450F280-28	PAF450F280-48
Input	Voltage Range	V	DC200 - 400			
	Efficiency (typ)	(*1) %	90	91		
	Current (typ)	(*1) A	1.81	1.79	1.81	1.79
Output	Nominal Voltage	VDC	12	24	28	48
	Maximum Current	A	38	19	16.5	9.5
	Maximum Power	W	456		462	456
	Voltage Setting Accuracy	(*1) %	+/-1			
	Maximum Line Regulation	(*2) mV	48	56		96
	Maximum Load Regulation	(*3) mV	48	56		96
	Temperature Coefficient		0.02%/°C			
	Maximum Ripple & Noise	(*9) mVp-p	120	240	280	480
	Voltage Adjustable Range	(*9)	-40%/ +20%			
Function	Over Current Protection	(*4)	105% - 140%			
	Over Voltage Protection	(*5)	125% - 145%			
	Remote Sensing	(*8)	Possible			
	Remote ON/OFF Control	(*8)	Possible (SHORT: ON OPEN: OFF)			
	Parallel Operation	(*8)	Possible			
	Series Operation	(*8)	Possible			
Environment	Operating Temperature	(*6) °C	-40 to +100(Baseplate) Ambient Temperature min=-40			
	Storage Temperature	°C	-40 to +100			
	Operating Humidity	%RH	5 - 95 (No dewdrop)			
	Storage Humidity	%RH	5 - 95 (No dewdrop)			
	Vibration		At no operating, 10-55Hz (sweep for 1min.) Amplitude 0.825mm constant (maximum 49.0m/s ²) X, Y, Z 1 hour each			
	Shock		196.1m/s ²			
	Cooling	(*7)	Conduction cooled			
Isolation	Withstand Voltage		Input-Output: 3.0kVAC, Input-Baseplate: 2.5kVAC(20mA) 1min Output-Baseplate: 500VDC 1min			
	Isolation Resistance		Output to Baseplate 500VDC more than 100MΩ(25°C,70%RH)			
Standards	Safety Standards		Approved by UL60950-1, CSA C22.2 No.60950-1, EN60950-1			
Mechanical	Weight (typ)	g	200			
	Size (W x H x D)	mm	61 x 12.7 x 116.8 (Refer to outline drawing)			

PAF

(*1) At 280VDC, nominal output voltage, maximum output current and baseplate temperature = +25°C.

(*2) 200 - 400VDC, constant load.

(*3) No load - full load, constant input voltage.

(*4) Constant current limiting with automatic recovery.

(*5) Inverter shutdown method, manual reset.

(*6) Ratings - Refer to derating curve.

- Load(%) is percent of maximum output current.

(*7) Heatsink has to be chosen according to instruction manual.

(*8) Refer to instruction manual.

(*9) External components are needed for operation.

(Refer to basic connection and instruction manual.)

Output Derating

● PAF450F280-12, 24, 28

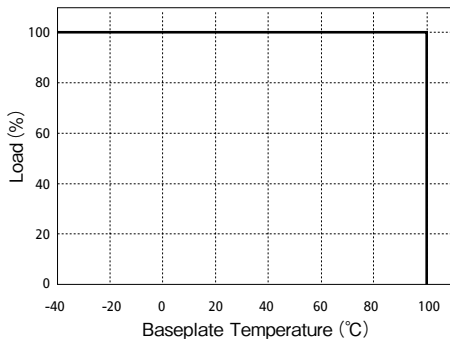

● PAF450F280-48

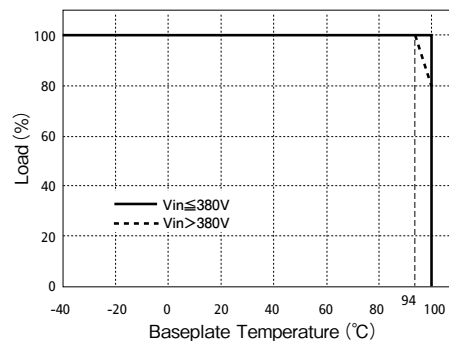

● Outline Drawing • Basic Connection B-102Page

PAF600F280 Specifications

ITEMS/UNITS		MODEL	PAF600F280-12	PAF600F280-24	PAF600F280-28	PAF600F280-48
Input	Voltage Range	V	DC200 - 400			
	Efficiency (typ)	(*1) %	89	91		
	Current (typ)	(*1) A	2.41	2.35	2.36	2.35
Output	Nominal Voltage	VDC	12	24	28	48
	Maximum Current	A	50	25	21.5	12.5
	Maximum Power	W	600		602	600
	Voltage Setting Accuracy	(*1) %	±1			
	Maximum Line Regulation	(*2) mV	48	56		96
	Maximum Load Regulation	(*2) mV	48	56		96
	Temperature Coefficient		0.02%/°C			
Function	Maximum Ripple & Noise	(*9) mVp-p	120	240	280	480
	Voltage Adjustable Range	(*9)	-40%/ +20%			
	Over Current Protection	(*4)	105% - 140%			
	Over Voltage Protection	(*5)	125% - 145%			
	Remote Sensing	(*8)	Possible			
	Remote ON/OFF Control	(*8)	Possible (SHORT: ON OPEN: OFF)			
	Parallel Operation	(*8)	Possible			
Environment	Series Operation	(*8)	Possible			
	Operating Temperature	(*6) °C	-40 to +100 (Baseplate) Ambient temperature min=-40			
	Storage Temperature	°C	-40 to +100			
	Operating Humidity	%RH	5 - 95 (No dewdrop)			
	Storage Humidity	%RH	5 - 95 (No dewdrop)			
	Vibration		At no operating, 10-55Hz (sweep for 1min.) Amplitude 0.825mm constant (maximum 49.0m/s ²) X, Y, Z 1 hour each			
	Shock		196.1m/s ²			
Isolation	Cooling	(*7)	Conduction cooled			
	Withstand Voltage		Input-Output: 3.0kVAC, Input-Baseplate: 2.5kVAC(20mA) 1min Output-Baseplate: 500VDC 1min			
	Isolation Resistance		Output to Baseplate 500VDC more than 100MΩ(25°C,70%RH)			
Standards	Safety Standards		Approved by UL60950-1, CSA C22.2 No.60950-1, EN60950-1			
Mechanical	Weight (typ)	g	200			
	Size (W x H x D)	mm	61 x 12.7 x 116.8 (Refer to outline drawing)			

PAF

- (*1) At 280VDC, nominal output voltage, maximum output current and baseplate temperature = +25°C.
- (*2) 200 - 400VDC, constant load.
- (*3) No load - full load, constant input voltage.
- (*4) Constant current limiting with automatic recovery.
- (*5) Inverter shutdown method, manual reset.
- (*6) Ratings - Refer to derating curve.
- Load(%) is percent of maximum output current.
- (*7) Heatsink has to be chosen according to instruction manual.
- (*8) Refer to instruction manual.
- (*9) External components are needed for operation. (refer to basic connection and instruction manual.)

Output Derating

● PAF600F280-12, 24, 28

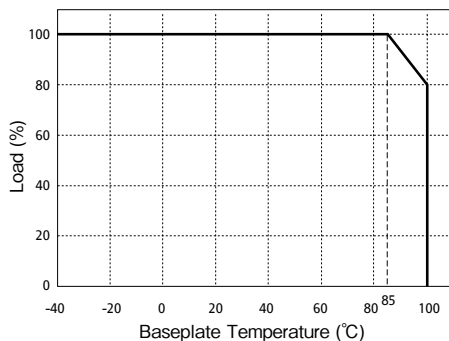

● PAF600F280-48

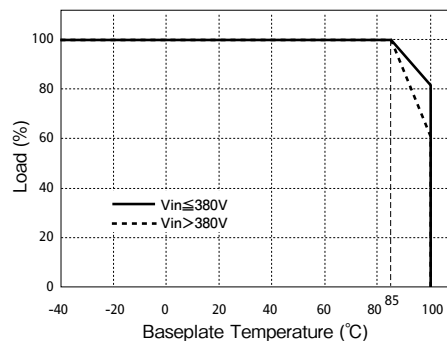

● Outline Drawing • Basic Connection B-102Page

Outline Drawing

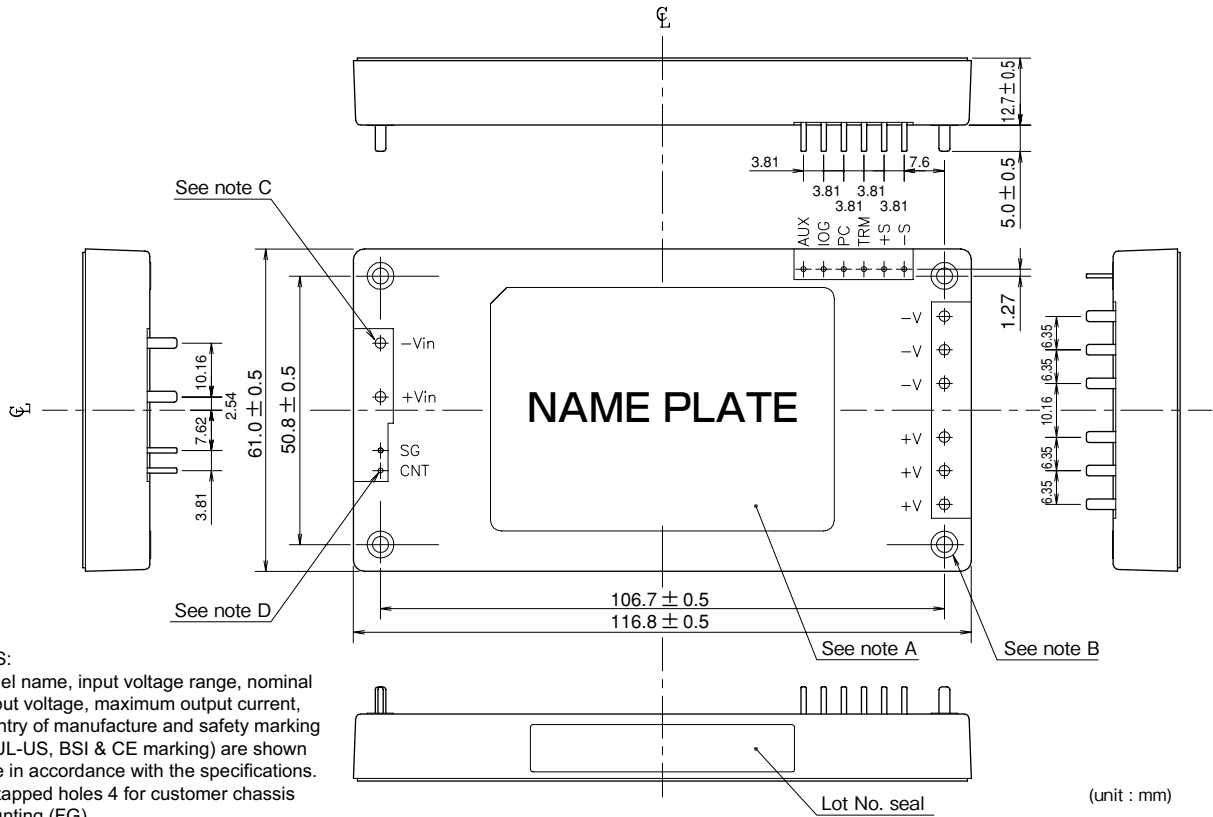

(unit : mm)

NOTES:

- A: Model name, input voltage range, nominal output voltage, maximum output current, country of manufacture and safety marking (C-UL-US, BSI & CE marking) are shown here in accordance with the specifications.
- B: M3 tapped holes 4 for customer chassis mounting (FG).
- C: Input and Output pin : 8-φ2
- D: Signal pin : 8-φ1
- E: Unless otherwise specified dimensional tolerance : ±0.3mm

PAF

Basic Connection

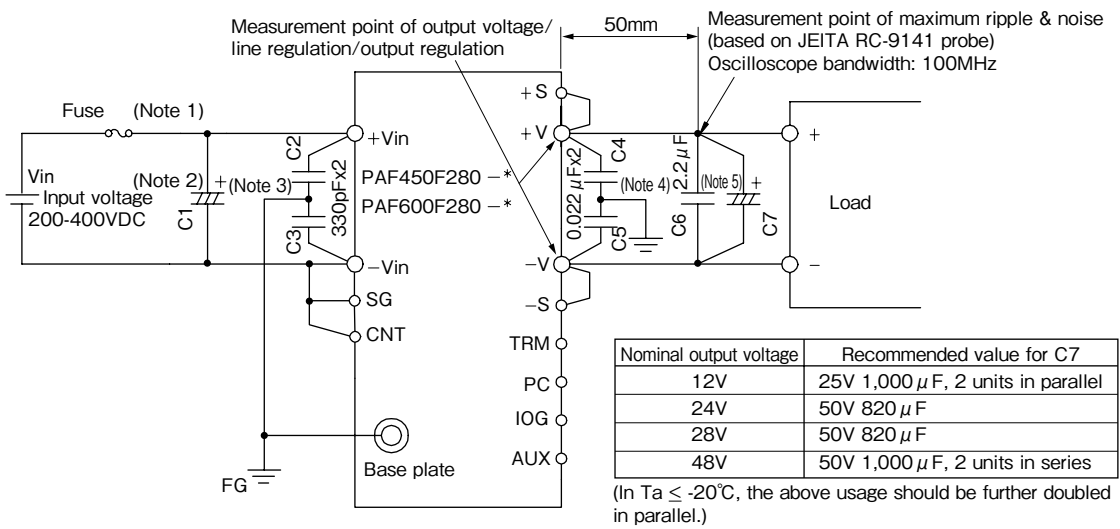

- Note 1: The PAF450F280/PAF600F280 series is not equipped with a fuse. Be sure to set a fast-blow type or normal-blow type fuse (6.3A) for the enhancement of safety and to get approval for safety standards. When using multiple units of the PAF series, set a fuse for each unit.
- Note 2: Capacitor C1
Connect a low-impedance electrolytic capacitor C1 (22μF or upper specifications) in order to reduce the effect of input line impedance.
- Note 3: Capacitor C2/C3
Connect a ceramic capacitor with 330pF (3kVAC or higher).
- Note 4: Capacitor C4/C5
Connect a film capacitor with 0.022μF (500VDC or higher).
- Note 5: Capacitor C7 (LXY manufactured by Nippon Chemi-Con Corporation or the equivalent)
Connect (aluminum) electrolytic capacitors indicated in the table at the lower right of the connection diagram (or their equivalent with the same capacity).
- Note 6: The measurement point of output voltage for assessing efficiency is to be the output terminal.

Block Diagram

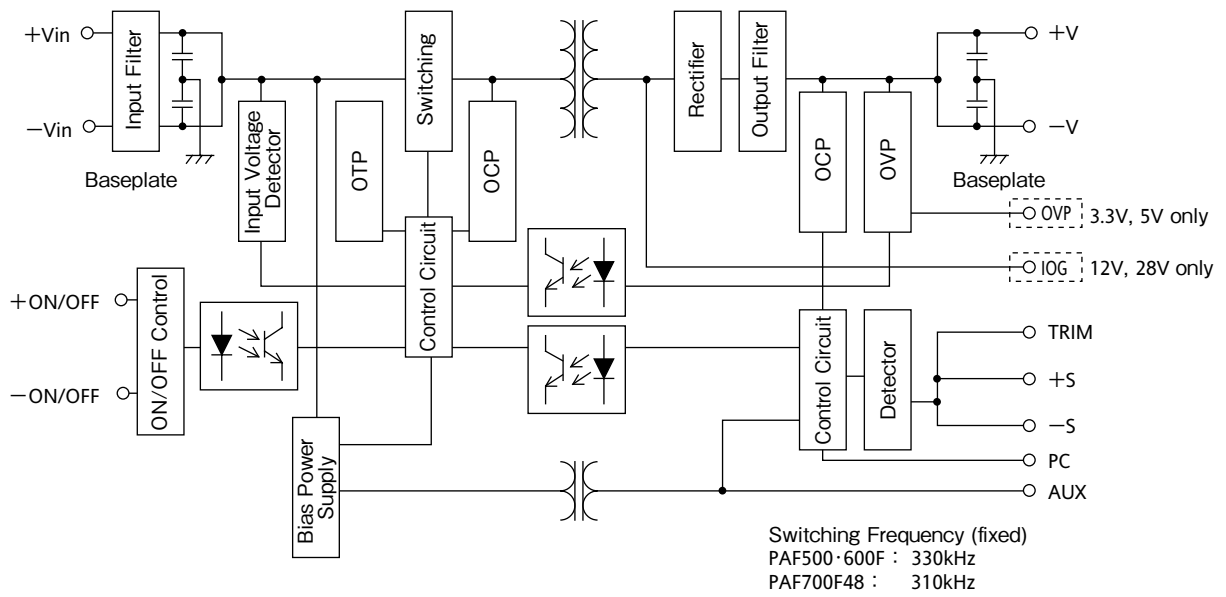

PAF

Sequence Time Chart

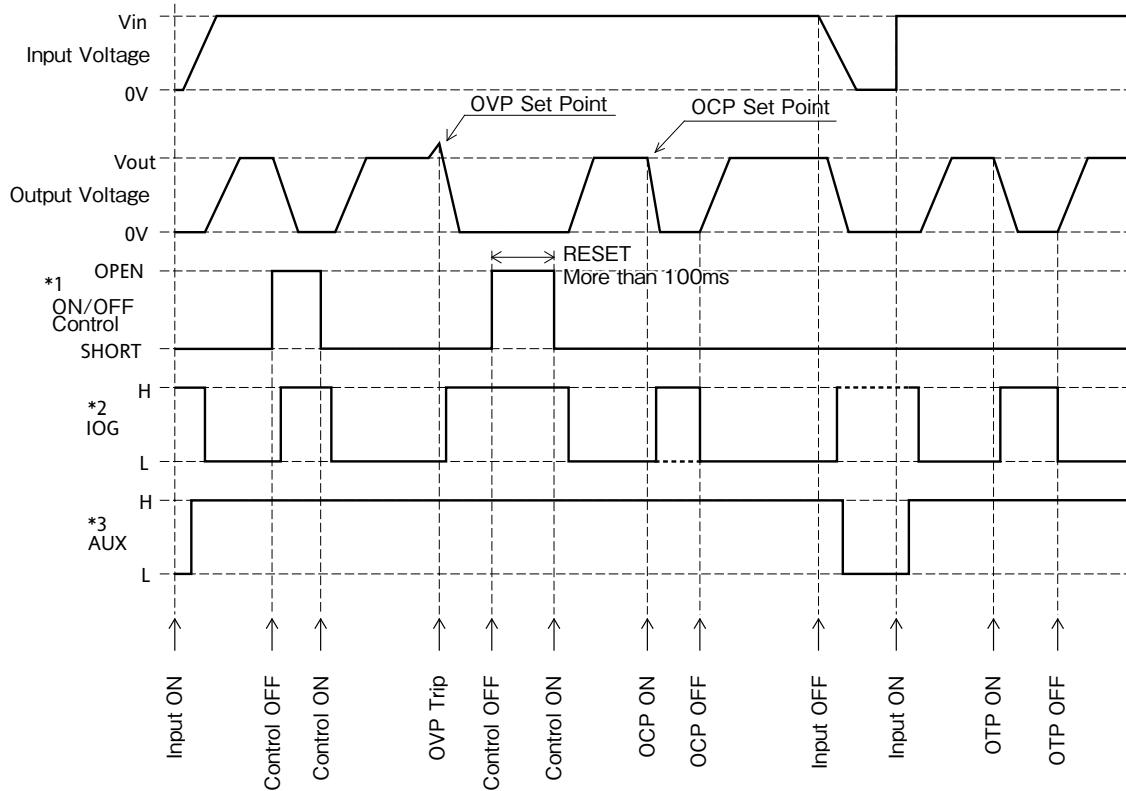

- *1 SHORT : $1\text{mA} \leq I(\text{ON/OFF}) \leq 5\text{mA}$
- *2 12V, 28V Model Only
- *3 H Level : 7 - 10VDC

Block Diagram

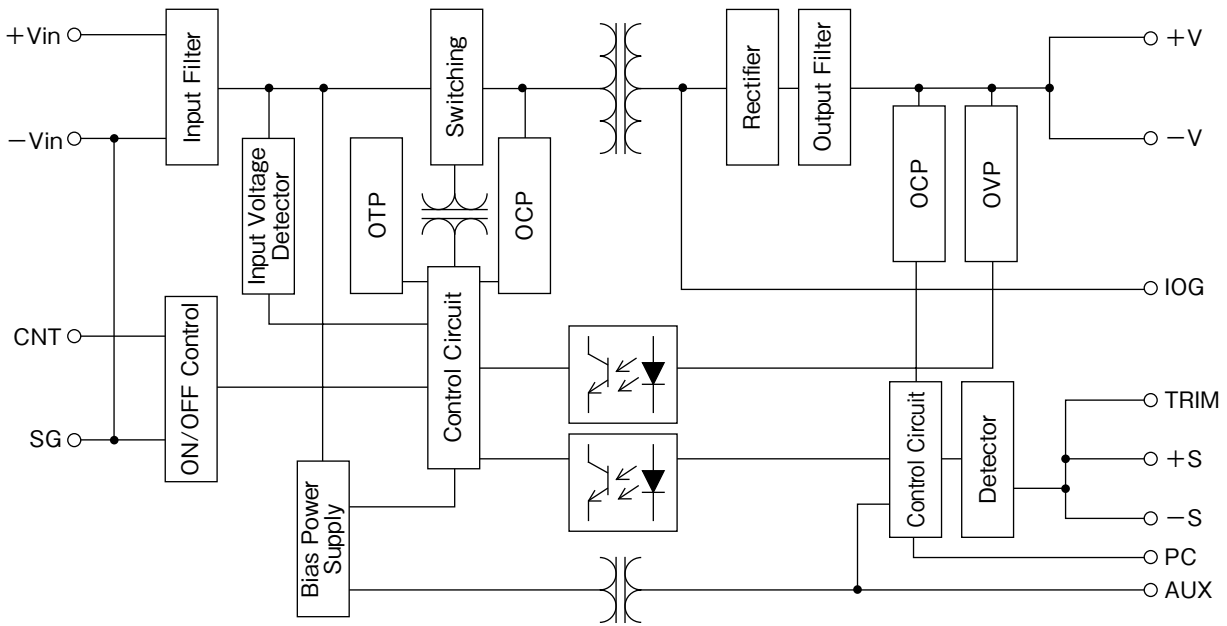

Switching Frequency : 200kHz

Sequence Time Chart

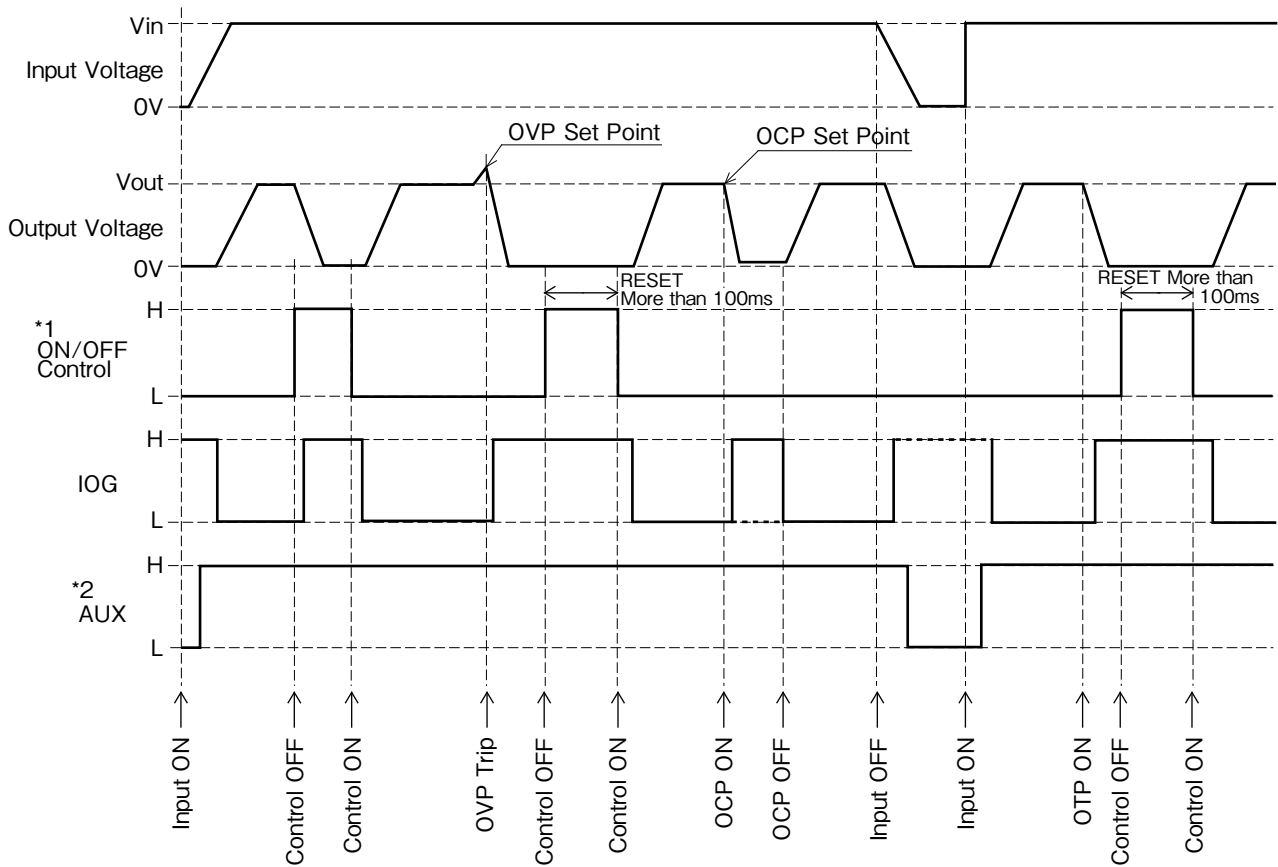

*1 Level : $4 \leq H \leq 35(V)$ or Open
 $0 \leq L \leq 0.8(V)$ or Short

*2 H Level : 10 - 13VDC

PAF500F24 SERIES Instruction Manual

Before using this product

Be sure to take note of precautions and warnings indicated in this manual when using this product. Improper usage may lead to electric shock or fire. Be sure to read this instruction manual thoroughly before using this product

Precautions

- Avoid touching the baseplate and the case of this product because they get hot.
- There are high voltage and high temperature components within this product. Refrain from disassembling this product or touching its internal components as this may lead to electric shock or burn.
- To avoid unexpected accident from placing hands or face near the unit during operation.
- Confirm connections to input/output terminals and signal terminals are correct as indicated in the instruction manual.
- For acquisition of various Safety Standards and safety improvement, be sure to use an external fuse. This product is designed for installation on electronic equipment.

- For input terminals of 24V input models, apply a voltage from a primary source with reinforced or double insulation.
- Output voltage of this product is considered to have hazardous energy level (voltage of 2V and above with power of 240W and above) and must not have physical contact with operator. Protection must be provided on this module when installed on equipment to prevent physical contact with service technician himself or accidentally dropped tools during repair. Before repair, be sure to turn off the input source and confirm that input and output voltage have dropped down to safe level.
- Application circuit or component values described in this instruction manual are for reference only. When designing circuit, be sure to verify actual circuit operation before determining final application circuit or component values. Contents of this instruction manual are subject to change without notice. When using this product, please refer to latest data sheet to satisfy this product specification.
- No part of this instruction manual may be reproduced, or transmitted in any form or by any other means without prior consent of Densai-Lambda, K.K.

PAF

1. Terminal Explanation

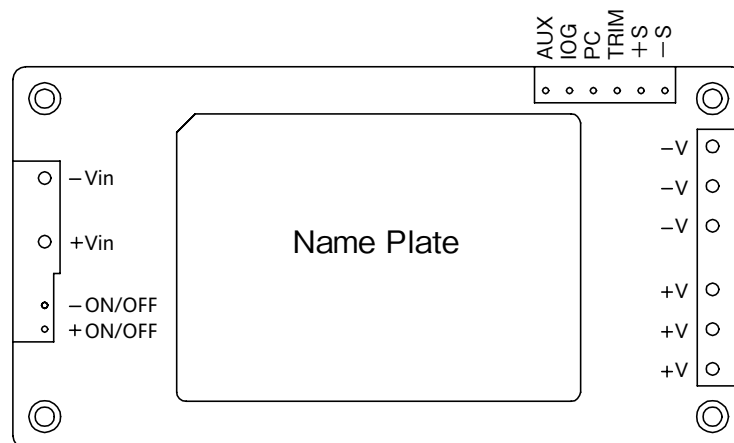

[Input Side Terminals]

+Vin : +Input Terminal
-Vin : -Input Terminal

[Control Terminals]

+ON/OFF : +ON/OFF Control
-ON/OFF : -ON/OFF Control

[Output Side Terminals]

+V : +Output Terminal
-V : -Output Terminal
+S : +Remote Sensing Terminal
-S : -Remote Sensing Terminal
TRIM : Output Voltage Trimming Terminal
PC : Output Current Balance Terminal
IOG : Inverter Operation Monitor terminal
AUX : Auxiliary Power Supply for External Signals

Baseplate can be connected to FG through M3 mounting tapped holes.
Connect +Vin, -Vin, +V, -V with consideration of contacting resistance.

2. Explanations on Specifications

1 Input Voltage Range

Input voltage range for PAF500F24 Series is indicated below.

Input Voltage Range:

- PAF500F24-12: 19 - 36VDC
- PAF500F24-28: 18 - 36VDC

Basically, ripple voltage (Vrpl) which results from rectification and filtering of commercial AC line is included within the input voltage as shown in Fig.1-1. Ripple voltage must be limited within the voltage described below.

Allowable input ripple voltage: 2Vp-p

When this value is exceeded, the output ripple voltage becomes large.

Note that abrupt input voltage change could cause the output voltage to fluctuate excessively.

Also, input voltage waveform peak value for high and low must not exceed above input voltage range.

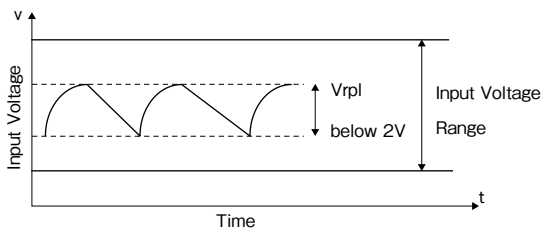

Fig.1-1 Ripple Voltage

Basic Connection

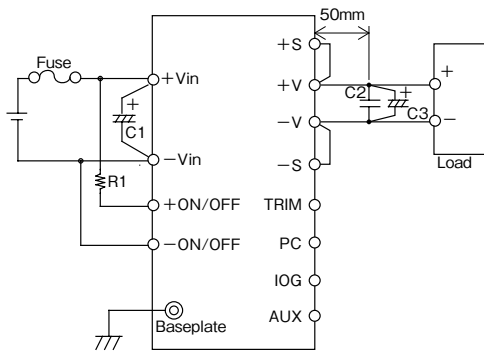

Fig.1-2 Basic Connection

Input Fuse

This power module has no built-in fuse. Use external fuse to acquire various Safety Standards and to improve safety. Also, use fast-blow type for every module.

Furthermore, fuse must be connected to the +Vin side if -Vin side is used as ground, or fuse must be connected to -Vin side if +Vin side is used as a ground.

Input Fuse recommended current rating: 50A

C1:

To prevent the effect of input line inductance to the power module, connect electrolytic capacitor or ceramic capacitor between +Vin and -Vin terminals.

Furthermore, use electrolytic capacitor with small ESR value. Especially take note that during line turn off at low ambient temperature, power module output will not normally shut down due to unstable C1 voltage.

Also, ripple current flows across this capacitor. Therefore, verify maximum allowable ripple current this capacitor when selecting component. Verify actual ripple current value by actual measurement.

Recommended capacitor value: 560μF × 2 pcs and above
(parallel connect)
(voltage rating 50V and above)

- Note) 1. Use low impedance electrolytic capacitor with excellent temperature characteristics. (Nippon Chemicon LXY Series or equivalent)
2. When input line inductance becomes excessively high due to insertion of choke coil, operation of the power module could become unstable. For this case, increase C1 value more than the value indicated above.
3. When ambient temperature becomes lower than -20 °C , connect 4 more and above capacitors indicated above in parallel to reduce ESR.

C2: 10μF

To reduce spike noise voltage at the output, connect a ceramic capacitor between +V and -V within 50mm distance from the output terminals.

Also, take note that output spike noise voltage could vary according to PCB wiring design.

C3:

For stable operation, connect an electrolytic capacitor between +V and -V within 50mm distance from the output terminals.

Take note that output ripple and output shutdown could be affected by electrolytic capacitor, equivalent impedance and inductance characteristics of wiring.

Take note that output ripple voltage could vary according to PCB wiring design.

For cases of abrupt changes in load current or input voltage, increasing capacitance value of the external capacitors could reduce the voltage fluctuation.

Vout	C3
12V	25V 470μF × 2 (* 1)
28V	50V 220μF × 2 (* 1)

*1 parallel connect

Table1-1 C3: Recommended Values of External Output Capacitor

- Note) 1. Use low impedance electrolytic capacitor with excellent temperature characteristics.
(Nippon Chemicon LXY Series or equivalent)
2. Use 4 more and above capacitors indicated above in parallel when ambient temperature becomes lower than -20°C to reduce ESR.
3. Take note of the allowable ripple current of the capacitor to be used. Especially, when load adding capacitors for abrupt current changes, be sure to verify that ripple current does not exceed allowable ripple current before use.

C4:

When switches or connectors are used between input source and PAF500F24 Series input terminals, impulse surge voltage is generated due to input throw-in by switch on/off or due to inserting/removing of power module from the active line. For this case, connect an additional electrolytic capacitor C4 as shown in Fig.1-3 and Fig.1-4.

Recommended Capacitance Value: 560μF and above (Voltage Rating 50V and above)

Also, in-rush current flows at line throw-in. Therefore, be sure to verify capability of switch or fuse to withstand I^2t at line throw-in.

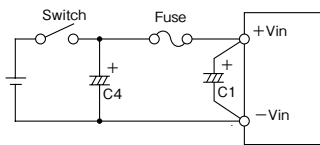

Fig.1-3 Input Filter with Input Switch

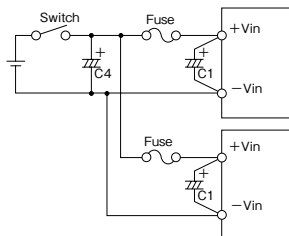

Fig.1-4 Input Filter when Plural Power

Reverse input connections

Reverse input polarity would cause module damage. For cases where reverse connections are possible, connect a protective diode or fuse. Use protective diode with higher voltage rating than the input voltage, and with higher surge current rating than the fuse.

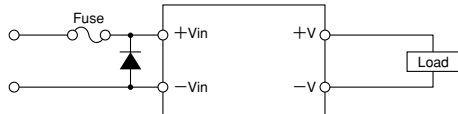

Fig.1-5 Protection for Reversed Connection of Input

Recommended input filter as EMI counter-measure (conforms to VCCI Class 1, FCC class A)

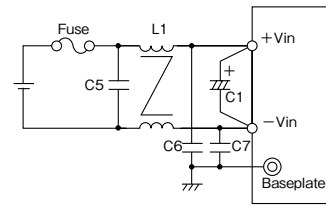

Fig.1-6 Recommended input filter as EMI countermeasure

Recommended Values:

- C1: 560μF (Electrolytic Capacitor) × 2 pcs in parallel
- C5: 2.2μF (Ceramic Capacitor)
- C6,C7: 0.1μF (Ceramic Capacitor)
- L1: 1 mH (Common mode choke coil)

- Note) 1. For the power module output, connect output capacitors described in the basic circuit connection.
2. VCCI Class 1, FCC Class A limits can be satisfied with the above recommended filter at Densai-Lambda measuring conditions. However, there are cases where above limits might not be satisfied due to input and output wiring method, as well as, peripheral circuits. When selecting input filter, be sure to verify actual EMI characteristics (CE and RE) before finalizing the filter. Refer to PAF500F24- * Evaluation Data for details.

PAF

2 Output Voltage Adjustment Range

Output voltage could be adjusted within the range described below by external resistor or variable resistor, or by applying external voltage. However, take note that OVP might trigger when output voltage adjustment exceeds the ranges indicated below.

Output Voltage Adjustment Range:
-40% to +10% of Nominal Output Voltage

Furthermore, when increasing the output voltage reduce the output current so as not to exceed the maximum output power.

Also, take note that when output voltage is increased, input voltage range is limited as shown in Fig. 2-1.

With the external circuit below, remote sensing is possible even when output voltage is varied. For details on remote sensing function, please refer to "9. Remote Sensing"

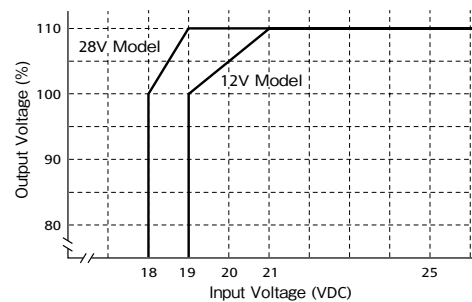

Fig.2-1 Limit of Input Voltage

Output Voltage Adjustment by external resistor or by variable resistor

Resistor values, as well as, connecting methods for external resistor (R2) and external variable resistor (VR) are described below.

In this case, using VR as remote programming resistor, remote programming of output voltage can be possible.

Output voltage rate of change versus VR resistor value is approximately 1V/kΩ. (Sensing current: about 1mA)

Also, be sure to connect remote programming resistor between +S terminal and +V terminal.

	12V	28V
R2	6.8k	6.8 k
VR	20k	50k

Unit : [Ω]

External Resistor : below ±5% Tolerance

Variable Resistor : below ±20% Tolerance
below 1% Remain

Table2-1 Values of External Resistor and Variable Resistor (−40% to +10% Variable)

	12V	28V
R2	43k	43k
VR	5k	10k

Unit : [Ω]

External Resistor : below ±5% Tolerance

Variable Resistor : below ±20% Tolerance
below 1% Remain

Table2-2 Values of External Resistor and Variable Resistor (±10% Variable)

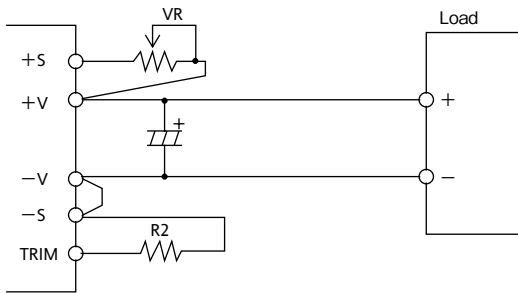

Fig.2-2 Example Connection of External Resistor

Output Voltage Adjustment by applying external voltage

By applying external voltage at the TRIM terminal, output voltage can be adjusted within the same output voltage adjustment range as the output voltage adjustment by external resistor or variable resistor. For this case, output voltage can be determined by the formula shown below.

$$\text{Output Voltage} = \text{TRIM Terminal Voltage} \times \text{Nominal Output Voltage}$$

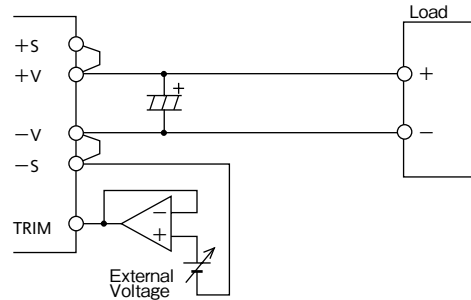

Fig.2-3 Output Voltage Adjustment by applying external voltage

For applications other than the above, refer to the trim circuit below and determine external circuit and component values.

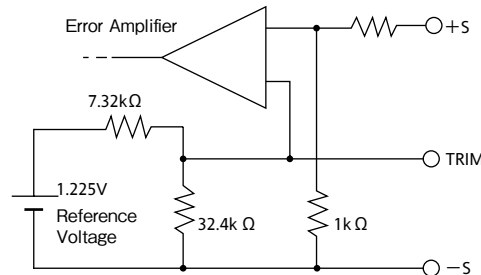

Fig.2-4 TRIM Circuit (For the Reference)

3 Maximum Ripple and Noise

Measured value according to the specified methods based on JEITA-9141 (Clause 7.12 and clause 7.13) which is described in the following.

Connect according to Fig.3-1 and measure. Connect capacitors (C2: ceramic capacitor 10 μF, C3: refer to table 1-1 for electrolytic capacitor values) at 50mm distance from the output terminals. Measure at ceramic capacitor (C2) leads as shown in Fig.3-1 using coaxial cable with JEITA attachment. Use oscilloscope with 100MHz frequency bandwidth or equivalent.

Take note that output ripple voltage and output spike noise may vary depending on PCB wiring design.

Generally, output ripple voltage and output spike noise can be reduced by increasing capacitance value of external capacitor.

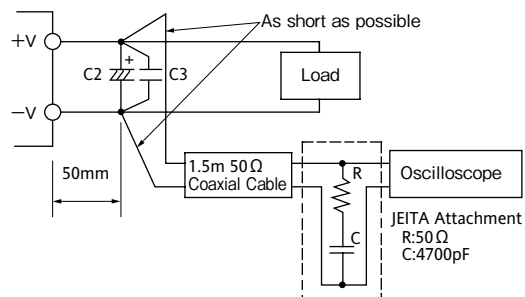

Fig.3-1 Measurement of Maximum Output Ripple & Noise

4 Maximum Line Regulation

Maximum value of output voltage change when input volt-

PAF

age is gradually varied (steady state) within specified input voltage range.

5 Maximum Load Regulation

Maximum value of output voltage change when output current is gradually varied (steady state) within specified output current range.

When using at dynamic load mode, audible noise could be heard from the power module and output voltage fluctuation might increase. A thorough pre-evaluation must be performed before using this power module.

6 Over Current Protection (OCP)

This power module has built-in OCP function.

Output will recover when short circuit or overload conditions are released. OCP setting value is fixed and therefore, cannot be externally adjusted.

Also, take note that power module might be damaged continuing output short circuit or over load conditions depending on thermal conditions.

7 Over Voltage Protection (OVP)

This power module has built-in OVP function.

As this set point is fixed, so adjustment voltage from the outside is impossible.

OVP set point is relative to the rated output voltage value. When OVP is triggered, output can be recovered by turning input line off and then turning it on again after lowering the input voltage below the voltage value indicated below, or by manual reset of the control ON/OFF terminal. Reset time for ON/OFF terminal is 100ms or longer.

OVP release input voltage value : 5VDC and below

When verifying OVP function by applying external voltage at the output terminals, applied voltage value should not exceed specified OVP maximum value. Refer to specification table for OVP maximum value. Avoid applying external voltage that exceeds OVP maximum value because this will cause power module damage.

8 Over Thermal Protection

This power module has built-in OTP function. This function operates and shuts down the output when ambient temperature or internal temperature of power module abnormally rises. OTP operates at 105°C to 130°C baseplate temperature. Output shutdown due to OTP can be released when baseplate temperature drops down approximately to within 80°C to 95°C. However, take note that OTP will operate again unless the cause of abnormal heat of the power module is eliminated.

9 Remote Sensing (+S, -S terminal)

Remote sensing terminal is provided to compensate for voltage drop across the wirings from the power module output terminal to the load input terminal.

When remote sensing function is not used (local sensing), short +S terminal to +V terminal and, -S terminal to -V terminal

Take note that voltage compensation range for line drop (voltage drop due to wiring) is determined such that output voltage at the output terminals is within output voltage range and that voltage between -V and -S terminals is within 2V or less. Even for remote sensing case, use power module such that output power is within specified maximum output power. Furthermore, reduce noise effect by using shielded wire, twisted pair, or parallel pattern.

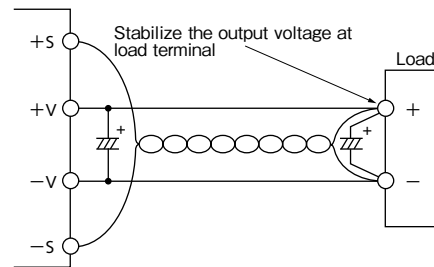

Fig.9-1 Remote Sensing at Use

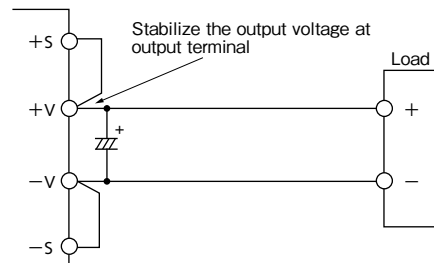

Fig.9-2 Remote Sensing Not in Use

10 ON/OFF Control(+ON/OFF, -ON/OFF terminal)

Output can also be turned ON/OFF even without turning the input line ON/OFF. An ON/OFF control circuit is provided which is isolated from the input side, as well as, the output side. (Isolation withstand voltage : 1.5kVDC).

Connection of ON/OFF terminal is as follows. As shown in the figure below, output voltage turns ON when current is made to flow through ON/OFF terminal. ON/OFF terminal can be controlled by opening or closing connections (with switch or relay), or by photo-coupler ON/OFF.

Maximum source current for ON/OFF terminal is 5mA. Therefore, set current limiting resistor value such that this maximum source current value is not exceeded. Also, the allowable maximum reverse current flow is 10mA.

A. Controlling the ON/OFF terminal from the input side

Connect current limiting resistor R1 as shown in Fig.10-1.

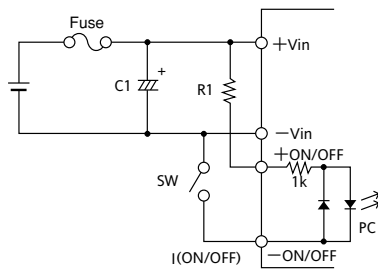

Fig.10-1 Connection of ON/OFF Control (A)
R1 Recommended Resistor value: 15kΩ(1/4W)

B. Controlling the ON/OFF terminal from the output side

Connect the current limiting resistor R4 as shown in Fig.10-2.

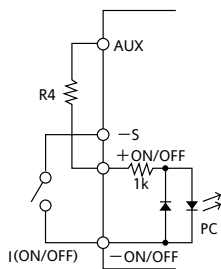

Fig.10-2 Connection of ON/OFF Control (B)
R4 Recommended Resistor Value: 2kΩ(1/6W)

C. Controlling the ON/OFF terminal by an external power supply

If necessary connect a current limiting resistor R5 as shown in Fig.10-3.

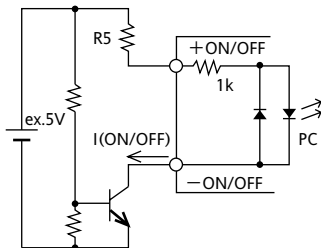

Fig.10-3 Connection of ON/OFF Control (C)

- Note) 1. When wiring becomes long, connect a capacitor of about 0.1μF value between the +ON/OFF terminal and -ON/OFF terminal at a nearest distance.
2. Current limiting resistor can also be connected to the -ON/OFF terminal side.

ON/OFF Level	Output Status	
	Standard	Option (*1)
Open	OFF	ON
1mA ≤ I(ON/OFF) ≤ 5mA	ON	OFF

*1 For option models, inquire to Densel-Lambda.
Table10-1 ON/OFF Control Mode

11 Parallel Operation (PC terminal)

By connecting the PC terminal of each power module, output current can be equally drawn from each module. A maximum of 11 units of the same model can be connected.

Furthermore, be sure that the output power of every module does not exceed the maximum output power value.

By setting output voltage accuracy of each module in a parallel operation to within ±1%, the maximum value of the output current that can be drawn is 95% of the total rated output current.

Refer to “Parallel Operation” of the Power Module Application Notes for details.

12 Series Operation

Series operation is possible for PAF500F24 series. Connections shown Fig.12-1 and Fig.12-2 is possible.

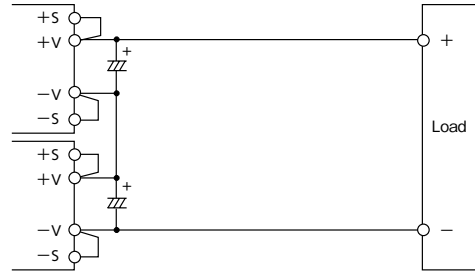

Fig.12-1 Series Operation in High Output Voltage

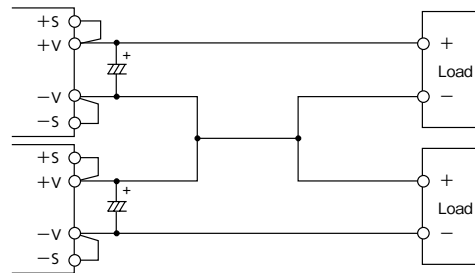

Fig.12-2 ± Output Series Operation

13 I.O.G. signal (IOG terminal)

Normal or abnormal operation of the power module can be monitored by using the IOG terminal. Output of this signal monitor is located at secondary side (output side) and is an open collector output.

This signal is LOW when inverter is normally operating and HIGH when inverter stops or when inverter is operating abnormally. (Maximum sink current is 5mA, maximum applied voltage is 35V)

Ground for the IOG terminal is the -S terminal.

Also note that IOG becomes unstable for following conditions:

- Operation of Over Current Protection (OCP)
- Light load conditions at parallel operation
- Dynamic load operation

14 Auxiliary power supply for external signals (AUX terminal)

For AUX terminal, output voltage value is within 7 - 10 VDC range, maximum output current is 20mA. Ground for the AUX terminal is -S terminal.

Avoid short circuit of AUX terminal with other terminals as this would lead to power module damage.

15 Operating ambient temperature

There is no restriction on mounting direction but there should be enough consideration for airflow so that heat does not accumulate around the power module vicinity. Determine external components configuration and mounting direction on PCB such that air could flow through the heatsink at forced cooling and conventional cooling.

By maintaining actual baseplate temperature below 100°C, operation is possible.

For details on thermal design, refer to Application Notes "Thermal Design".

Note) Maximum baseplate temperature is 100°C. For worst case operating condition, verify baseplate temperature at measurement point indicated in Fig. 15-1.

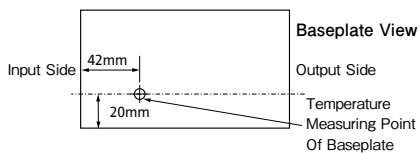

Fig.15-1 Temperature Measurement Point of Baseplate

For better improvement of power module reliability, derating of baseplate temperature when using is recommended.

16 Operating Ambient Humidity

Take note that moisture could lead to power module abnormal operation or damage.

17 Storage Ambient Temperature

Abrupt temperature change would cause moisture formation that leads to poor solderability of each terminal of the power module.

18 Storage Ambient Humidity

Take enough care when storing the power module because rust which causes poor solderability would form in each terminal when stored in high temperature, high humidity environment.

19 Cooling Method

Operating temperature range is specified by the baseplate temperature. Therefore, several method of heat dissipation is possible.

For details on thermal design, refer to ApplicationNotes "Thermal Design".

20 Baseplate Temperature vs. Output Voltage Drift

Output voltage drift is defined as the rate of voltage change when baseplate temperature only is changed during operation.

21 Withstand Voltage

This power module is designed to have a withstand voltage of 1.5kVDC between input to baseplate, 1.5kVDC between input to output, 1.5kVDC between the control terminals to input/output and 500VDC between output to baseplate for 1 minute. When conducting withstand voltage test during incoming inspection, be sure to apply DC voltage. Also, set the current limit value of the withstand voltage testing equipment to 10mA.

Be sure to avoid conducting test with AC voltage because this would cause power module damage.

Furthermore, avoid throw in or shut off of the testing equipment when applying or when shutting down the test voltage. Instead, gradually increase or decrease the applied voltage. Take note especially not to use the timer of the test equipment because when the timer switches the applied voltage off, impulse voltage which has several times the magnitude of the applied voltage is generated causing damage to the power module.

Short the output side as shown in the diagram below.

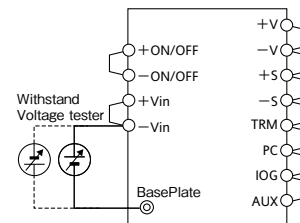

1.5kVDC 1minute (10mA)
Fig.21-1 Withstand Voltage Tester for Input-Baseplate

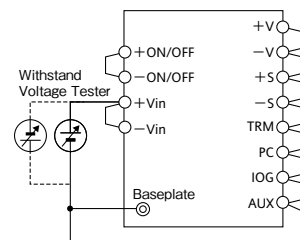

1.5kVDC 1minute (10mA)
Fig.21-2 Withstand Voltage Tester for Input-Output

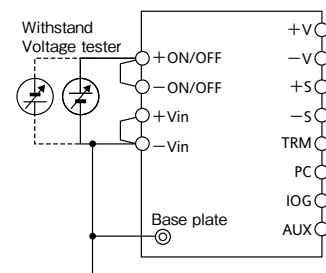

1.5kVDC 1minute (10mA)
Fig.21-3 Withstand Voltage Tester for ON/OFF-Input/Output

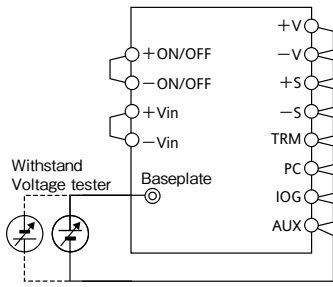

500VDC 1minute (10mA)
Fig.21-4 Withstand Voltage Tester for
Output-Baseplate

22 Insulation Resistance

Use DC insulation tester (MAX 500V) between output and baseplate. Insulation resistance value is 100MΩ and above at 500VDC applied voltage. Also take note that depending on the insulation tester used, some testers generate high voltage pulse. Discharge the power module after test using a resistor, etc.

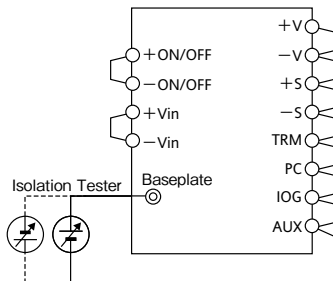

Over 100MΩ at 500VDC
Fig.22-1 Isolation Test

4. Before concluding power module damage

Verify following items before concluding power module damage.

1) No output voltage

- Is specified input voltage applied?
- Are the ON/OFF control terminal (+ON/OFF, -ON/OFF), remote sensing terminal (+S, -S), output voltage trimming terminal (TRIM) correctly connected?
- Is output current of the auxiliary power supply for external signals terminal (AUX) within the specified value ?
- For cases where output voltage adjustment is used, is the resistor or variable resistor setting, connections correctly done?
- Are there no abnormalities in the output load used?
- Is the baseplate temperature within the specified temperature range?

2) Output voltage is high

- Are the remote sensing terminals (+S, -S) correctly connected?
- Is the measurement done at the sensing points?
- For cases where output voltage adjustment is used, is the resistor or volume setting, connections correctly done?

3) Output voltage is low

- Is specified input voltage applied?
- Are the remote sensing terminals (+S, -S) correctly connected?
- Is the measurement done at the sensing points?
- For cases where output voltage adjustment is used, is the resistor or variable resistor setting, connections correctly done?
- Are there no abnormalities in the output load used?

4) Load regulation and line regulation is large

- Is specified input voltage applied?
- Are the input terminals and the output terminals firmly connected?
- Is the measurement done at the sensing points?
- Is the input or output wire too thin?

5) Output ripple voltage is large

- Is the measuring method used the same or equivalent with the specified method in the Application Notes?
- Is the input ripple voltage value within the specified value?

23 Withstand Vibration

Refer to Application Notes "Mounting Method" section.

24 Withstand Shock

Withstand shock value is defined to be the value at Denset Lambda shipment and packaging conditions.

25 Others

The performance of a system with Power Module is influenced according to various conditions -- PCBs, chassis, mechanics, heat dissipation. Please evaluate actual products, and confirm its performance. (For details, please refer Power Module Application Note.)

PAF600F24 SERIES Instruction Manual

● PAF450F280, 600F280 Instruction Manual  B-123Page

Before using this product

Be sure to take note of precautions and warnings indicated in this manual when using this product. Improper usage may lead to electric shock or fire. Be sure to read this instruction manual thoroughly before using this product

Precautions

- Avoid touching the baseplate and the case of this product because they get hot.
- There are high voltage and high temperature components within this product. Refrain from disassembling this product or touching its internal components as this may lead to electric shock or burn.
- To avoid unexpected accident from placing hands or face near the unit during operation.
- Confirm connections to input/output terminals and signal terminals are correct as indicated in the instruction manual.
- For acquisition of various safety standards and safety improvement, be sure to use an external fuse. This product is designed for installation on electronic equipment.
- For input terminals of 24V input models, apply an voltage

from a primary source with reinforced or double insulation.

- Output voltage of this product is considered to have hazardous energy level (voltage of 2V and above with power of 240W and above) and must not have physical contact with operator. Protection must be provided on this module when installed on equipment to prevent physical contact with service technician himself or accidentally dropped tools during repair. Before repair, be sure to turn off the input source and confirm that input and output voltage have drop down to a safe level.
- Application circuit or component values described in this instruction manual are for reference only. When designing circuit, be sure to verify actual circuit operation before determining final application circuit or component values. Contents of this instruction manual are subject to change without notice. When using this product, please refer to latest data sheet to satisfy this product specification.
- No part of this instruction manual may be reproduced, or transmitted in any form or by any other means without prior consent of Densai-Lambda, K.K.

PAF

1.Explanations on Specifications

*Please refer to PAF500F24 instruction manual for other specifications.

1 Input Voltage Range

Input voltage range for PAF600F24 Series is indicated below.

Input Voltage Range:

PAF600F24-12 20-36VDC

PAF600F24-28 19-36VDC

2 Output Voltage Adjustment Range

Output voltage could be adjusted within the range described below by external resistor or variable resistor, or by applying external voltage. However, take note that OVP might trigger when output voltage adjustment exceeds the ranges indicated below.

Output Voltage Adjustment Range

-40% to +10% of nominal output voltage

Furthermore, when increasing the output voltage reduce the output current so as not to exceed the maximum output power.

Also, take note that when output voltage is increased, input voltage range is limited as shown in Fig. 2-1.

With the external circuit below, remote sensing is possible even when output voltage is varied.

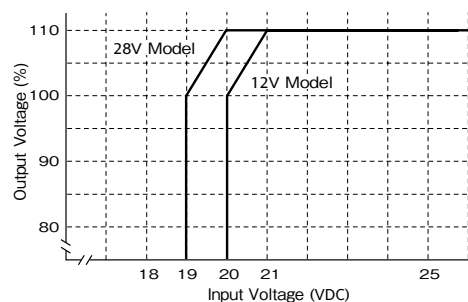

Fig.2-1 Limit of Input Voltage

PAF500, 600, 700F48 SERIES Instruction Manual

Before using this product

Be sure to take note of precautions and warnings indicated in this manual when using this product. Improper usage may lead to electric shock or fire. Be sure to read this instruction manual thoroughly before using this product

⚠ Precautions

- Avoid touching the baseplate and the case of this product because they get hot.
- There are high voltage and high temperature components within this product. Refrain from disassembling this product or touching its internal components as this may lead to electric shock or burn.
- To avoid unexpected accident from placing hands or face near the unit during operation.
- Confirm connections to input/output terminals and signal terminals are correct as indicated in the instruction manual.
- For acquisition of various Safety Standards and safety improvement, be sure to use an external fuse. This product is designed for installation on electronic equipment.
- For input terminals of 48V input models, apply a voltage from a primary source with reinforced or double insulation.

- Output voltage of this product is considered to have hazardous energy level (voltage of 2V and above with power of 240W and above) and must not have physical contact with operator. Protection must be provided on this module when installed on equipment to prevent physical contact with service technician himself or accidentally dropped tools during repair. Before repair, be sure to turn off the input source and confirm that input and output voltage have dropped down to a safe level.
- Application circuit or component values described in this instruction manual are for reference only. When designing circuit, be sure to verify actual circuit operation before determining final application circuit or component values. Contents of this instruction manual are subject to change without notice. When using this product, please refer to latest data sheet to satisfy this product specification.
- No part of this instruction manual may be reproduced, or transmitted in any form or by any other means without prior consent of Densei-Lambda, K.K.

Note : CE Marking

CE Marking, when applied to a product covered by instruction manual, indicates compliance with the low voltage directive which complies with EN60950

PAF

1. Terminal Explanation

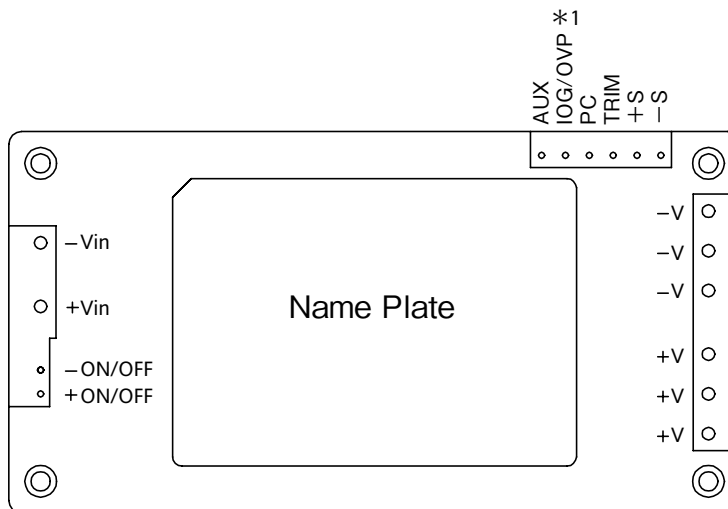

[Input Side Terminals]

+Vin: +Input Terminal
-Vin: -Input Terminal

[Control Terminals]

+ON/OFF: +ON/OFF Control
-ON/OFF: -ON/OFF Control

[Output Side Terminals]

+V: +Output Terminal
-V: -Output Terminal
+S: +Remote Sensing
-S: -Remote Sensing
TRIM: Output Voltage Trimming Terminal
PC: Output Current Balance Terminal
IOG/OVP: Inverter Operation Good (IOG; 12V, 28V Model)*1
Over Voltage Protection Operating Voltage Trimming Terminal (OVP; 3.3V, 5V Model)*1
AUX: Auxiliary Power Supply for External Signals

*1 Depending on the model, this terminal is IOG terminal or OVP terminal.

Baseplate can be connected to FG through M3 mounting tapped holes.
Connect +Vin, -Vin, +V, -V with consideration of contacting resistance.

2. Explanations on Specifications

1 Input Voltage Range

Input voltage range for PAF500, 600, 700F48 Series is indicated below.

Input Voltage Range: 36 ~ 76VDC

Basically, ripple voltage (Vrpl) which results from rectification and filtering of commercial AC line is included within the input voltage as shown in Fig.1-1. Ripple voltage must be limited within the voltage described below.

Allowable input ripple voltage: 4Vp-p

When this value is exceeded, the output ripple voltage becomes large.

Note that sudden input voltage change may cause variation of output voltage transitionally.

Also, input voltage waveform peak value must not exceed above input voltage range.

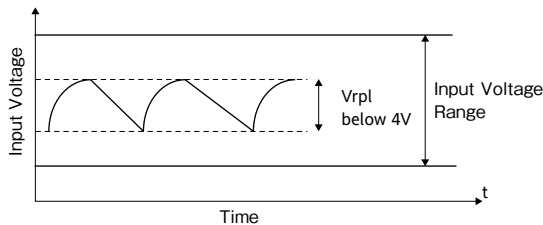

Fig.1-1 Ripple Voltage

Basic Connection

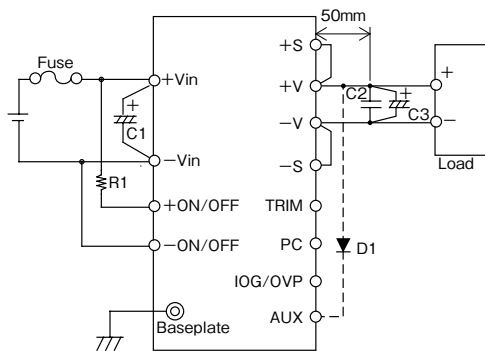

Fig.1-2 Basic Connection

Input Fuse

This power module has no built-in fuse. Use external fuse to acquire various Safety Standards and to improve safety. Also, use fast-blow type for every module.

Furthermore, fuse must be connected to the +Vin side if -Vin side is used as ground, or fuse must be connected to -Vin side if +Vin side is used as a ground.

**Input Fuse recommended current rating : 30A
(F30AH, 100/250V)**

C1:

To prevent the effect of input line inductance to the power module, connect electrolytic capacitor or ceramic capacitor between +Vin and -Vin terminals.

Furthermore, use electrolytic capacitor with small ESR value. Especially take note that during line turn off at low ambient temperature, power module output will not normally shut down due to unstable C1 voltage.

Also, ripple current flows across this capacitor. Therefore, verify maximum allowable ripple current this capacitor when selecting component. Verify actual ripple current value by actual measurement.

Recommended capacitor value

**PAF500, 600F48: 100μF and above
(voltage rating 100V and above)**

**PAF700F48: 220μF × 2 and above
(voltage rating 100V and above)**

- Note) 1. Use low impedance electrolytic capacitor with excellent temperature characteristics. (Nippon Chemicon LXV Series or equivalent)
2. When input line inductance becomes excessively high due to insertion of choke coil, operation of the power module could become unstable. For this case, increase C1 value more than the value indicated above.
3. For PAF500, 600F48 series, when ambient temperature becomes lower than -20°C, connect two capacitors indicated above in parallel to reduce ESR.

C2: 10μF

To reduce spike noise voltage at the output, connect a ceramic capacitor between +V and -V within 50mm distance from the output terminals.

Also, take note that output spike noise voltage could vary according to PCB wiring design.

C3:

For stable operation, connect an electrolytic capacitor between +V and -V at 50mm distance from the output terminals.

Take note that output ripple and output shutdown could be affected by electrolytic capacitor, equivalent impedance and inductance characteristics of wiring.

Take note that output ripple voltage could vary according to PCB wiring design.

For cases of abrupt changes in load current or input voltage, increasing capacitance value of the external capacitors could reduce the voltage fluctuation.

Vout	C3
3.3V	10V 5600μF × 2 (*1)
5V	10V 5600μF × 2 (*1)
12V	25V 470μF
28V	50V 220μF

*1 parallel connect

Table1-1 C3: Recommended Values of External Output Capacitor

- Note) 1. Use low impedance electrolytic capacitor with excellent temperature characteristics. (Nippon Chemicon LXY Series or equivalent)
2. For 12V, 28V models, use capacitors indicated above in parallel when ambient temperature becomes lower than -20°C to reduce ESR. Quantity for capacitors are as follows.
 PAF500F48: 2pcs
 PAF600F48: 3pcs
 PAF700F48: 4pcs
3. Take note of the allowable ripple current of the capacitor to be used. Especially, when load adding capacitors for abrupt current changes, be sure to verify that ripple current does not exceed allowable ripple current before use.

C4:

When switches or connectors are used between input source and PAF500, 600, 700F48 Series input terminals, impulse surge voltage is generated due to input throw-in by switch on/off or due to inserting/removing of power module from the active line. For this case, connect an additional electrolytic capacitor C4 as shown in fig.1-3 and fig.1-4.

Recommended Capacitance Value: 100 μF and above (Voltage Rating 100V and above)

Also, in-rush current flows at line throw-in. Therefore, be sure to verify capability of switch or fuse to withstand I²t at line throw-in.

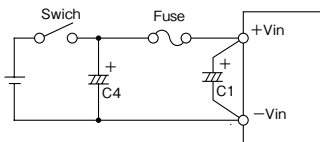

Fig.1-3 Input Filter with Input Switch

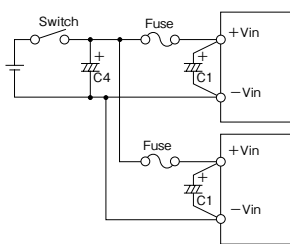

Fig.1-4 Input Filter when Plural Power

D1:

Only for 3.3V and 5V models, for stable output operation at momentary input voltage line-drop, connect small VF value schottky barrier diode D1.

Recommended reverse voltage rating: 30V and above
Recommended current rating: 100mA and above

Reverse input connections

Reverse input polarity would cause module damage. For cases where reverse connections are possible, connect a protective diode or fuse. Use protective diode with higher voltage rating than the input voltage, and with higher surge current rating than the fuse.

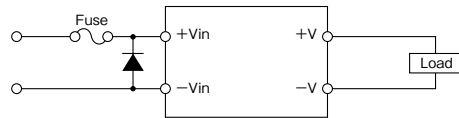

Fig.1-5 Protection for Reversed Connection of Input

● **Recommended input filter as EMI counter-measure (conforms to VCCI Class 1, FCC class A)**

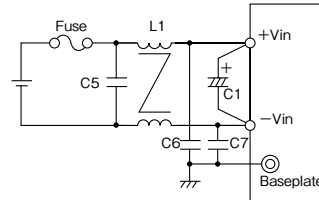

Fig.1-6 Recommended input filter as EMI countermeasure

Recommended Values:

- C1: 470μF (Electrolytic Capacitor)
- C5: 2.2μF (Ceramic Capacitor)
- C6,C7: PAF500F48 - 0.1μF
- C6,C7: PAF600, 700F48 - 0.15μF (Ceramic Capacitor)
- L1: 1 mH (Common mode choke coil)

- Note) 1. For the power module output, connect output capacitors described in the basic circuit connection.
2. VCCI Class 1, FCC Class A limits can be satisfied with the above recommended filter at Densei-Lambda measuring conditions. However, there are cases where above limits might not be satisfied due to input and output wiring method, as well as, peripheral circuits. When selecting input filter, be sure to verify actual EMI characteristics (CE and RE) before finalizing the filter. Refer to PAF500F48- * or PAF600F48- * or PAF700F48- * Evaluation Data for details.

2 Output Voltage Adjustment Range

Output voltage could be adjusted within the range described below by external resistor or variable resistor, or by applying external voltage. However, take note that OVP might trigger when output voltage adjustment exceeds the ranges indicated below.

Output Voltage Adjustment Range

- 3.3V, 5V: -40% to +20% of Nominal Output Voltage
- 12V, 28V
 - PAF500·600F48: -40% to +10% of Nominal Output Voltage
 - PAF700F48: -40% to +15% of Nominal Output Voltage

Furthermore, when increasing the output voltage reduce the output current so as not to exceed the maximum output power.

Also, take note that when output voltage is increased, input voltage range is limited as shown in fig. 2-1.

With the external circuit below, remote sensing is possible even when output voltage is varied. For details on remote sensing function, please refer to "9. Remote Sensing"

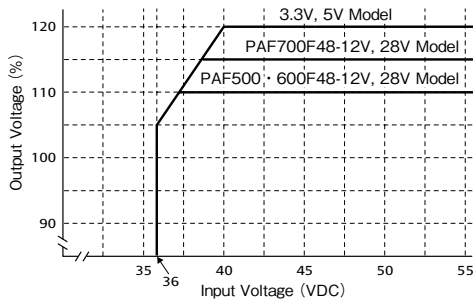

Fig.2-1 Limit of Input Voltage

Output Voltage Adjustment by external resistor or by variable resistor

Resistor values, as well as, connecting methods for external resistor (R2) and external variable resistor (VR) are described below.

In this case, using VR as remote programming resistor, remote programming of output voltage can be possible.

Also, be sure to connect remote programming resistor between +S terminal and +V terminal.

	3.3V	5V	12V	28V
R2	3.9k	6.8k	6.8k	6.8 k
VR	10k	10k	20k	50k

Unit : [Ω]

External Resistor: below ±5% Tolerance

Variable Resistor: below ±20% Tolerance
below 1% Remain

Table2-1 Values of External Resistor and Variable Resistor

- 3.3V, 5V : -40% to +20% Variable
- 12V, 28V : -40% to +10% Variable
- PAF500·600F48 : -40% to +15% Variable
- PAF700F48 : -40% to +15% Variable

	3.3V	5V	12V	28V
R2	20k	43k	43k	43k
VR	2k	2k	5k	10k

Unit: [Ω]

External Resistor: below ±5% Tolerance

Variable Resistor: below ±20% Tolerance
below 1% Remain

Table2-2 Values of External Resistor and Variable Resistor (±10% Variable)

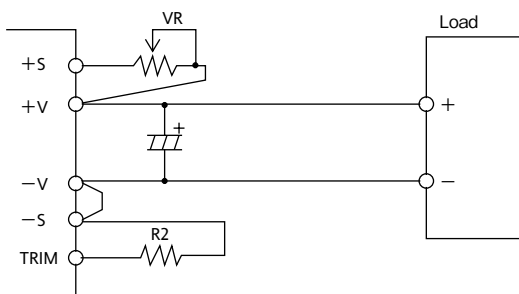

Fig.2-2 Example Connection of External Resistor

Output Voltage Adjustment by applying external voltage

By applying external voltage at the TRIM terminal, output voltage can be adjusted within the same output voltage adjustment range as the output voltage adjustment by external resistor or variable resistor. For this case, output voltage can be determined by the formula shown below.

$$\text{Output Voltage} = \text{TRIM Terminal Voltage} \times \text{Nominal Output Voltage}$$

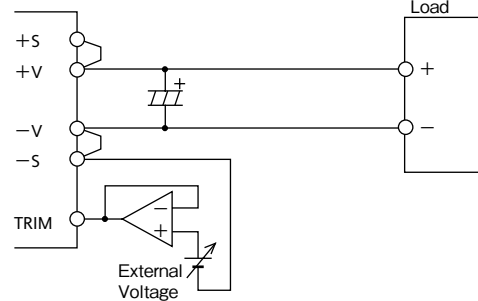

Fig.2-3 Output Voltage Adjustment by applying external voltage

For applications other than the above, refer to the trim circuit below and determine external circuit and component values.

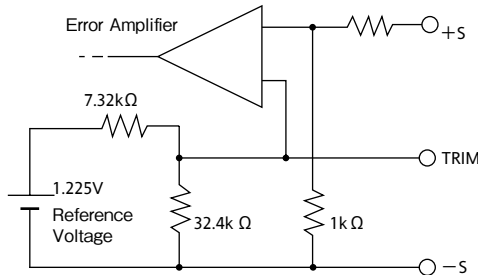

Fig.2-4 TRIM Circuit (For the Reference)

PAF

3 Maximum Ripple and Noise

Measured value according to the specified methods based on JEITA-9141 (Clause 7.12 and clause 7.13) which is described in the following.

Connect according to fig.3-1 and measure. Connect capacitors (C2: ceramic capacitor 10μF, C3: refer to table 1-1 for electrolytic capacitor values) at 50mm distance from the output terminals. Measure at ceramic capacitor (C2) leads as shown in fig. 3-1 using coaxial cable with JEITA attachment. Use oscilloscope with 100MHz frequency bandwidth or equivalent.

Take note that output ripple voltage and output spike noise may vary depending on PCB wiring design.

Generally, output ripple voltage and output spike noise can be reduced by increasing capacitance value of external capacitor.

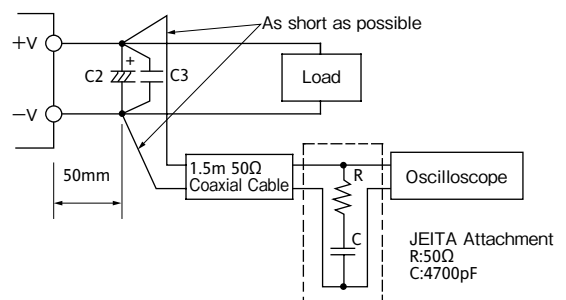

Fig.3-1 Measurement of Maximum Output Ripple & Noise

4 Maximum Line Regulation

Maximum value of output voltage change when input voltage is gradually varied (steady state) within specified input voltage range.

5 Maximum Load Regulation

Maximum value of output voltage change when output current is gradually varied (steady state) within specified output current range.

When using at dynamic load mode, audible noise could be heard from the power module and output voltage fluctuation might increase. A thorough pre-evaluation must be performed before using this power module.

6 Over Current Protection (OCP)

This power module has built-in OCP function. Output will recover when short circuit or overload conditions are released. OCP setting value is fixed and therefore, cannot be externally adjusted. Also, take note that power module might be damaged continuing output short circuit or over load conditions depending on thermal conditions.

7 Over Voltage Protection (OVP; OVP terminal)

This power module has built-in OVP function. OVP set point is relative to the rated output voltage value. When OVP is triggered, output can be recovered by turning input line off and then turning it on again after lowering the input voltage below the voltage value indicated below, or by manual reset of the control ON/OFF terminal. Reset time for ON/OFF terminal is 100ms or longer.

OVP release input voltage value: 24VDC and below

When verifying OVP function by applying external voltage at the output terminals, applied voltage value should not exceed specified OVP maximum value. Refer to specification table for OVP maximum value. Avoid applying external voltage that exceeds OVP maximum value because this will cause power module damage.

For 3.3V, 5V models, OVP setting value could be adjusted as described below by external resistor connections. OVP setting value for 12V, 28V models is fixed and cannot be adjusted externally.

OVP setting adjustment method (for 3.3V, 5V models only)

For 3.3V, 5V models, when output voltage is set lower than the typical output voltage rating, OVP setting value can be adjusted by connecting external resistor (R3) between OVP terminal and -V terminal. When connecting external resistor (R3) to the -V terminal, wiring should be made such that the effect of voltage drop due to load current is eliminated.

When there is no need to change OVP setting value, be sure to leave the OVP terminal open.

OVP setting adjustment range is shown below.

OVP Setting Adjustment Range
 3.3V: 2.60V - 4.785V (78.8% - 145%)
 5V: 3.50V - 6.75V (70% - 135%)

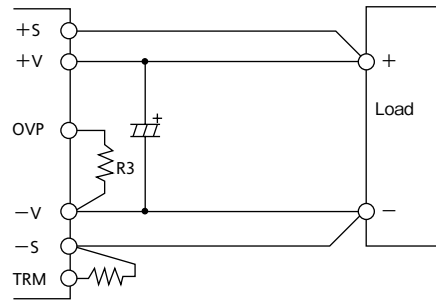

Fig.7-1 Example Connection of External Resistor

Formula for determining OVP setting value (Vovp: TYP value) by external resistor (R3) connection is shown below.

$$V_{ovp} = V_{ref} \cdot \frac{R3 + 100}{R3 + 1100} \cdot \frac{r1 + r2}{r2}$$

Vovp: OVP Setting Value
 Vref: Internal Reference Voltage (TYP 1.225V)
 r1, r2: Internal Output Voltage Detecting resistor (Refer to below table)

	3.3V	5V
r1	8.2k	6.8k
r2	2.7k	1.5k

Unit : [Ω]

Table7-1 r1, r2 Resistor Value (TYP Value)

Also, formula for determining external resistor (R3) value (TYP value) to set OVP voltage value (Vovp) arbitrarily within the above range is shown below.

$$R3 = \frac{V_{ref} \cdot 100 \cdot (r1 + r2) - V_{ovp} \cdot r2 \cdot 1100}{V_{ovp} \cdot r2 - (r1 + r2) \cdot V_{ref}}$$

Graph representation of the above formulae is shown in fig. 7-2.

Resistor value calculated from this formula is a typical value. When using this function verify that OVP functions properly triggers at setting value by raising output voltage using TRIM terminal, or by applying external voltage.

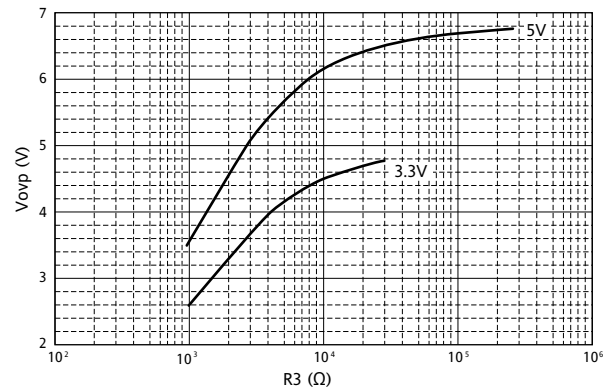

Fig.7-2 OVP Setting Voltage - R3 Resistor Value (TYP Value)

When using the remote sensing function, output voltage at the output terminals of the power module generally becomes higher than the voltage at the load input terminals.

OVP circuit monitors output voltage from the output terminals. Therefore, for cases where remote sensing function is used together, consider voltage drop from the power module output terminals to the load input terminals when setting OVP value.

Output voltage of the power module transitionally changes when output load or input voltage suddenly change. For this case, set enough margin for output voltage peak when setting OVP value.

Be sure to verify beforehand that OVP does not falsely trigger at actual evaluation for worst output load or input voltage conditions

8 Over Thermal Protection

This power module has built-in OTP function. This function operates and shuts down the output when ambient temperature or internal temperature of power module abnormally rises. OTP operates at 105°C to 130°C baseplate temperature. Output shutdown due to OTP can be released when baseplate temperature drops down approximately to within 80°C to 95°C. However, take note that OTP will operate again unless the cause of abnormal heat of the power module is eliminated.

9 Remote Sensing (+S, -S terminal)

Remote sensing terminal is provided to compensate for voltage drop across the wirings from the power module output terminal to the load input terminal.

When remote sensing function is not used (local sensing), short +S terminal to +V terminal and, -S terminal to -V terminal.

Take note that voltage compensation range for line drop (voltage drop due to wiring) is determined such that output voltage at the output terminals is within output voltage range and that voltage between -V and -S terminals is within 2V or less. Even for remote sensing case, use power module such that output power is within specified maximum output power. Furthermore, reduce noise effect by using shielded wire, twisted pair, or parallel pattern.

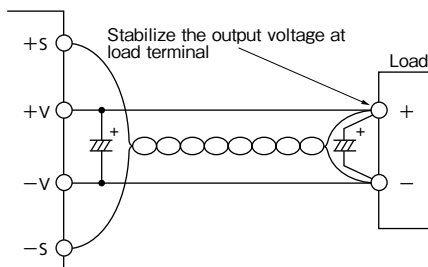

Fig.9-1 Remote Sensing at Use

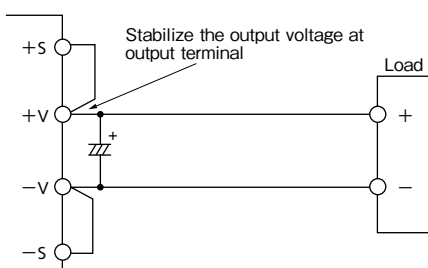

Fig.9-2 Remote Sensing Not in Use

• All specifications are subject to change without notice.

10 ON/OFF Control(+ON/OFF, -ON/OFF terminal)

Output can also be turned ON/OFF even without turning the input line ON/OFF. An ON/OFF control circuit is provided which is isolated from the input side as well as the output side. (Isolation withstand voltage: 1.5kVDC).

Connection of ON/OFF terminal is as follows. As shown in the figure below, output voltage turns ON when current is made to flow through ON/OFF terminal. ON/OFF terminal can be controlled by opening or closing connections (with switch or relay), or by photo-coupler ON/OFF.

Maximum source current for ON/OFF terminal is 5mA. Therefore, set current limiting resistor value such that this maximum source current value is not exceeded. Also, the allowable maximum reverse current flow is 10mA.

A. Controlling the ON/OFF terminal from the input side

Connect current limiting resistor R1 as shown in fig 10-1.

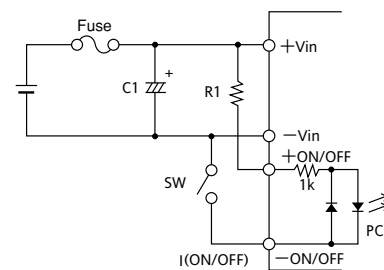

Fig.10-1 Connection of ON/OFF Control (A)
R1 Recommended Resistor Value: 30kΩ(1/2W)

B. Controlling the ON/OFF terminal from the output side

Connect the current limiting resistor R4 as shown in fig. 10-2.

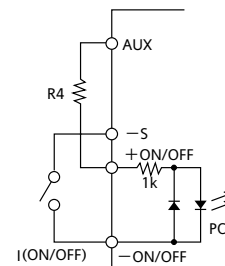

Fig.10-2 Connection of ON/OFF Control (B)
R4 Recommended Resistor Value: 2kΩ(1/6W)

C. Controlling the ON/OFF terminal by an external power supply

If necessary connect a current limiting resistor R5 as shown in fig.10-3.

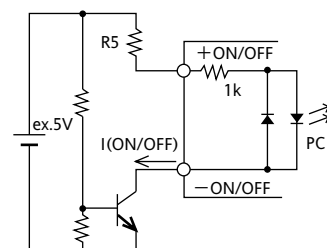

Fig.10-3 Connection of ON/OFF Control (C)

Note) 1. When wiring becomes long, connect a capacitor of about 0.1μF value between the +ON/OFF terminal and -ON/OFF terminal at a nearest distance.

2. Current limiting resistor can also be connected to the -ON/OFF terminal side.

ON/OFF Level	Output Status	
	Standard	Option (*1)
Open	OFF	ON
$1mA \leq I(ON/OFF) \leq 5mA$	ON	OFF

* 1 For option models, inquire to Densel-Lambda.
Table10-1 ON/OFF Control Mode

11 Parallel Operation (PC terminal)

By connecting the PC terminal of each power module, output current can be equally drawn from each module. A maximum of 11 units of the same model can be connected.

Furthermore, be sure that the output power of every module does not exceed the maximum output power value.

By setting output voltage accuracy of each module in a parallel operation to within $\pm 1\%$, the maximum value of the output current that can be drawn is 95% of the total rated output current.

Refer to "Parallel Operation" of the Power Module Application Notes for details.

12 Series Operation

Series operation is possible for PAF500, 600, 700F48 series. Connections shown fig.12-1 and fig.12-2 are possible.

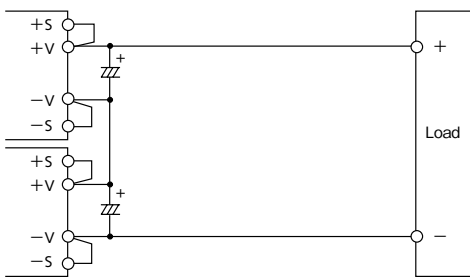

Fig.12-1 Series Operation in High Output Voltage

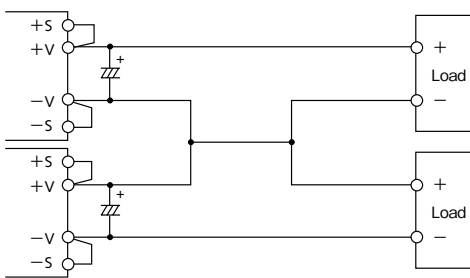

Fig.12-2 ± Output Series Operation

13 I.O.G. signal (IOG terminal)

This function is built-in for 12V, 28V models.

Normal or abnormal operation of the power module can be monitored by using the IOG terminal. Output of this signal monitor is located at secondary side (output side) and is an open collector output.

This signal is LOW when inverter is normally operating and HIGH when inverter stops or when inverter is operating abnormally. (Maximum sink current is 5mA, maximum applied voltage is 35V.)

Ground for the IOG terminal is the -S terminal.

Also note that IOG becomes unstable for following conditions:

- Operation of Over Current Protection (OCP)
- Light load conditions at parallel operation
- Dynamic load operation

Also take note that this function cannot be used for 3.3V and 5V models.

14 Auxiliary power supply for external signals (AUX terminal)

For AUX terminal, output voltage value is within 7~10VDC range, maximum output current is 20mA. Ground for the AUX terminal is -S terminal.

Avoid short circuit of AUX terminal with other terminals as this would lead to power module damage.

15 Operating ambient temperature

There is no restriction on mounting direction but there should be enough consideration for airflow so that heat does not accumulate around the power module vicinity. Determine external components configuration and mounting direction on PCB such that air could flow through the heatsink at forced cooling and conventional cooling.

By maintaining actual baseplate temperature below 100°C, operation is possible.

For details on thermal design, refer to Application Notes "Thermal Design".

Note) 1. Maximum baseplate temperature is 100°C. For worst case operating condition, verify baseplate temperature at measurement point indicated in fig. 15-1.

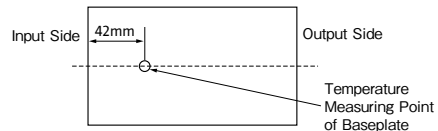

Fig.15-1 Temperature Measurement Point of Baseplate

2. There is limitation on baseplate temperature range for PAF700F48 as shown in fig.15-2.

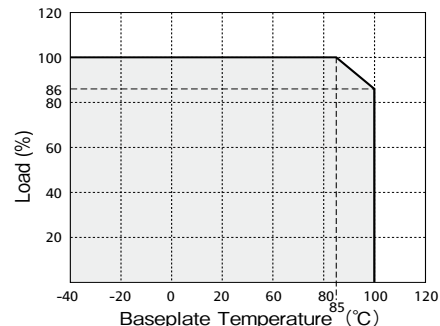

Fig.15-2 PAF700F48 Derating curve

For better improvement of power module reliability, derating of baseplate temperature when using is recommended.

16 Operating Ambient Humidity

Take note that moisture could lead to power module abnormal operation or damage.

PAF

17 Storage Ambient Temperature

Abrupt temperature change would cause moisture formation that leads to poor solderability of each terminal of the power module.

18 Storage Ambient Humidity

Take enough care when storing the power module because rust which causes poor solderability would form in each terminal when stored in high temperature, high humidity environment.

19 Cooling Method

Operating temperature range is specified by the baseplate temperature. Therefore, several method of heat dissipation is possible.

For details on thermal design, refer to Application Notes "Thermal Design".

20 Baseplate Temperature vs. Output Voltage Drift

Output voltage drift is defined as the rate of voltage change when baseplate temperature only is changed during operation.

21 Withstand Voltage

This power module is designed to have a withstand voltage of 1.5kVDC between input to baseplate, 1.5kVDC between input to output, 1.5kVDC between the control terminals to input/output and 500VDC between output to baseplate for 1 minute. When conducting withstand voltage test during incoming inspection, be sure to apply DC voltage. Also, set the current limit value of the withstand voltage testing equipment to 10mA.

Be sure to avoid conducting test with AC voltage because this would cause power module damage.

Furthermore, avoid throw in or shut off of the testing equipment when applying or when shutting down the test voltage. Instead, gradually increase or decrease the applied voltage. Take note especially not to use the timer of the test equipment because when the timer switches the applied voltage off, impulse voltage which has several times the magnitude of the applied voltage is generated causing damage to the power module.

Short the output side as shown in the diagram below.

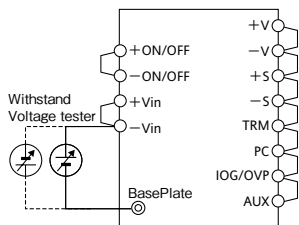

1.5kVDC 1minute (10mA)
Fig.21-1 Withstand Voltage Tester for Input-Baseplate

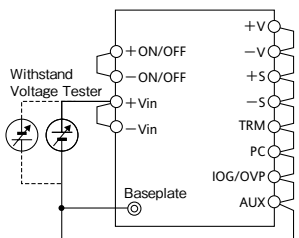

1.5kVDC 1minute (10mA)
Fig.21-2 Withstand Voltage Tester for Input-Output

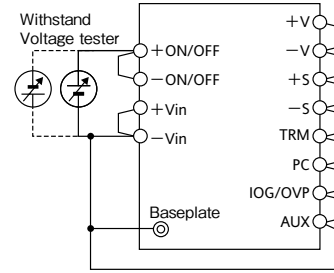

1.5kVDC 1minute (10mA)
Fig.21-3 Withstand Voltage Tester for ON/OFF-Input/Output

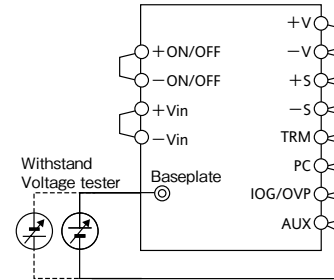

500VDC 1minute (10mA)
Fig.21-4 Withstand Voltage Tester for Output-Baseplate

22 Insulation Resistance

Use DC insulation tester (MAX 500V) between output and baseplate. Insulation resistance value is 100MΩ and above at 500VDC applied voltage. Also take note that depending on the insulation tester used, some testers generate high voltage pulse. Discharge the power module after test using a resistor, etc.

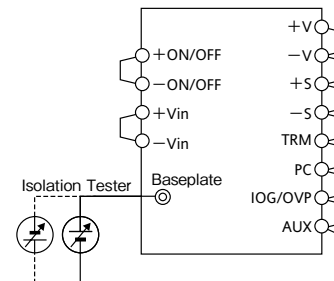

Over 100MΩ at 500VDC
Fig.22-1 Isolation Test

23 Withstand Vibration

Refer to Application Notes "Mounting Method" section.

24 Withstand Shock

Withstand shock value is defined to be the value at Densel Lambda shipment and packaging conditions.

25 Others

The performance of a system with Power Module is influenced according to various conditions -- PCBs, chassis, mechanics, heat dissipation. Please evaluate actual products, and confirm its performance. (For details, please refer Power Module Application Note.)

4. Before concluding power module damage

Verify following items before concluding power module damage.

1) No output voltage

- Is specified input voltage applied?
- Are the ON/OFF control terminal (+ON/OFF, -ON/OFF), remote sensing terminal (+S, -S), output voltage trimming terminal (TRIM), Over Voltage Protection operating voltage trimming terminal (OVP) correctly connected?
- Is output current of the auxiliary power supply for external signals terminal (AUX) within the specified value ?
- For cases where output voltage adjustment is used, is the resistor or variable resistor setting, connections correctly done?
- Are there no abnormalities in the output load used?
- Is the baseplate temperature within the specified temperature range?

2) Output voltage is high

- Are the remote sensing terminals (+S, -S) correctly connected?
- Is the measurement done at the sensing points?
- For cases where output voltage adjustment is used, is the resistor or volume setting, connections correctly done?

3) Output voltage is low

- Is specified input voltage applied?
- Are the remote sensing terminals (+S, -S) correctly connected?
- Is the measurement done at the sensing points?
- For cases where output voltage adjustment is used, is the resistor or variable resistor setting, connections correctly done?
- Are there no abnormalities in the output load used?

4) Load regulation and line regulation is large

- Is specified input voltage applied?
- Are the input terminals and the output terminals firmly connected?
- Is the measurement done at the sensing points?
- Is the input or output wire too thin?

5) Output ripple voltage is large

- Is the measuring method used the same or equivalent with the specified method in the Application Notes?
- Is the input ripple voltage value within the specified value?

PAF450F280, PAF600F280 SERIES Instruction Manual

● PAF-F24, -F48 Instruction Manual  B-105Page

Before using this product

Be sure to take note of precautions and warnings indicated in this manual when using this product. Improper usage may lead to electric shock or fire. Be sure to read this instruction manual thoroughly before using this product

Precautions

- Avoid touching the baseplate and the case of this product because they get hot.
- There are high voltage and high temperature components within this product. Refrain from disassembling this product or touching its internal components as this may lead to electric shock or burn.
- To avoid unexpected accident from placing hands or face near the unit during operation.
- Confirm connections to input/output terminals and signal terminals are correct as indicated in the instruction manual.
- Attach a fast blow type external fuse to each module to ensure safety operation and compliance to each safety standard approval.
- This power module is designed for professional installation within the end user equipment.
- Output voltage of this product is considered to have hazardous energy level (voltage of 2V and above with power of

240W and above) and must not have physical contact with operator. Protection must be provided on this module when installed on equipment to prevent physical contact with service technician himself or accidentally dropped tools during repair. Before repair, be sure to turn off the input source and confirm that input and output voltage have dropped down to a safe level.

- The application circuits and their parameter are for reference only. Be sure to verify effectiveness of application circuits and their parameters before finalizing circuit design.
- The information in this document is subject to change without prior notice. For actual design-in, please refer to the latest publications of data sheet, etc., for the most up-to date specifications of the unit.
- No part of this document may be copied or reproduced in any for, or by any mean without prior written consent of Den-sei-Lambda.

Note : CE Marking

CE Marking, when applied to a product covered by instruction manual, indicates compliance with the low voltage directive in which complies with EN60950.

PAF

1. Terminal Explanation

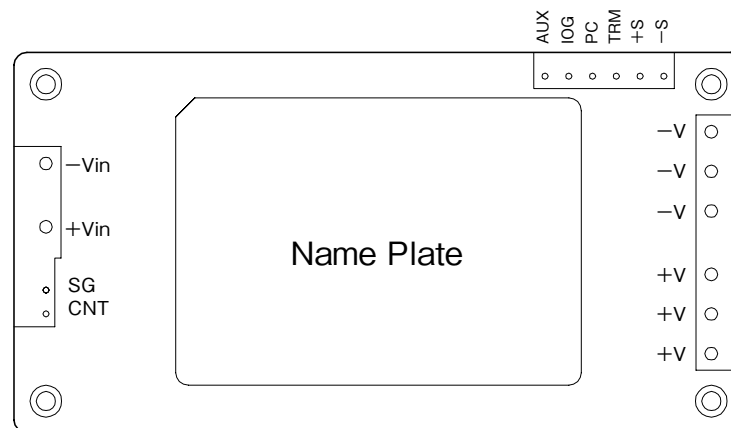

[Input Side Terminals]

+Vin: +Input Terminal
-Vin: -Input Terminal

[Control Terminals]

CNT: ON/OFF Control terminal
SG: ON/OFF Control (ground side) terminal

[Output Side Terminals]

+V: +Output Terminal
-V: -Output Terminal

+S: +Remote Sensing

-S: -Remote Sensing

TRIM: Output Voltage Trimming Terminal

PC: Output Current Balance Terminal

IOG: Inverter Operation Good

AUX: Auxiliary Power Supply for External Signals

Baseplate can be connected to FG through M3 mounting tapped holes.
Connect +Vin, -Vin, +V, -V with consideration of contacting resistance.

2. Explanations on Specifications

1 Input Voltage Range

Input voltage range for PAF450F280 and PAF600F280 Series is indicated below.

Input voltage range: 200 - 400VDC

Basically, ripple voltage (V_{rpl}) which results from rectification and filtering of commercial AC line is included within the input voltage as shown in Fig.1-1. Ripple voltage must be limited within the voltage described below.

Allowable input ripple voltage: 20Vp-p

When this value is exceeded, the output ripple voltage becomes large.

Note that sudden input voltage change may cause variation of output voltage transitionally.

Also, input voltage waveform peak value must not exceed above input voltage range.

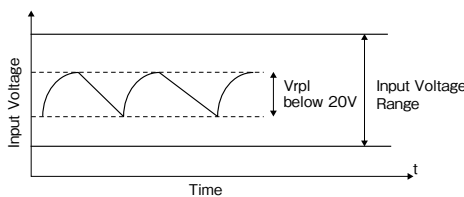

Fig.1-1 Ripple Voltage

Basic Connection

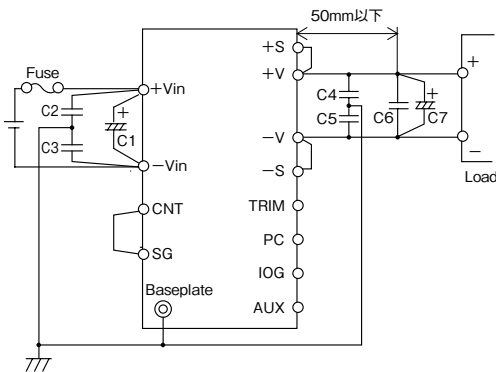

Fig.1-2 Basic Connection

Input Fuse

This power module has no built-in fuse. Use external fuse to acquire various Safety Standards and to improve safety. Also, use fast-blow type or normal-blow type for every module.

Input fuse recommended current rating: 6.3A (400VDC)

C1 :

To prevent the effect of input line inductance to the power module, connect electrolytic capacitor or ceramic capacitor between +Vin and -Vin terminals.

Furthermore, use electrolytic capacitor with small ESR value. Especially take note that during line turn off at low ambient temperature, power module output will not normally shut down due to unstable C1 voltage.

Also, ripple current flows across this capacitor. Therefore, verify maximum allowable ripple current this capacitor when selecting component. Verify actual ripple current value by actual measurement.

Recommended capacitor value: 22 μ F and above (voltage rating 400V and above)

Note) 1. Use low impedance electrolytic capacitor with excellent temperature characteristics.

2. When input line inductance becomes excessively high due to insertion of choke coil, operation of the power module could become unstable. For this case, increase C1 value more than the value indicated above.

3. When ambient temperature becomes lower than -20°C, connect four capacitors indicated above in parallel because output fall characteristics could be affected by ESR.

C2, C3 : 330pF

To reduce spike noise voltage at the output, connect the high withstand voltage ceramic capacitor from +Vin terminal, -Vin terminal to the baseplate.

Withstand Voltage of C2,C3: 3kVac and above

Note) 1. Connect the C2 between +Vin terminal and baseplate, and the C3 between -Vin terminal and baseplate with the short connections as possible.

2. There are cases where output ripple voltage could vary according to input wiring method or peripheral circuits. For this case, increase C2 and C3 value or connect common mode choke coil before C1.

C4, C5: 0.022 μ F

To reduce spike noise voltage at the output, connect a ceramic capacitor.

Withstand voltage of C4, C5: 500VDC and above

Connect the C4 between +V terminal and baseplate, and the C5 between -V terminal and baseplate with the short connections as possible.

C6: 2.2 μ F

To reduce spike noise voltage at the output, connect a ceramic capacitor between +V and -V within 50mm distance from the output terminals.

Also, take note that output spike noise voltage could vary according to PCB wiring design.

C7:

For stable operation, connect an electrolytic capacitor between +V and -V at 50mm distance from the output terminals.

Take note that output ripple and output fall characteristics could be affected by electrolytic capacitor, equivalent impedance and inductance characteristics of wiring.

Take note that output ripple voltage could vary according to PCB wiring design.

For cases of abrupt changes in load current or input voltage, increasing capacitance value of the external capacitors could reduce the voltage fluctuation.

Vout	C7
12V	25V 1,000 μ F x 2 parallel
24V	50V 820 μ F
28V	50V 820 μ F
48V	50V 1,000 μ F x 2 series

Table1-1 C7: Recommended Values of External Output Capacitor

- Note) 1. Use low impedance electrolytic capacitor with excellent temperature characteristics.
(Nippon Chemicon LXY Series or equivalent)
2. Use capacitors indicated in table 1-1 in parallel when ambient temperature becomes lower than -20°C because output ripple voltage could be affected by ESR. Quantities for capacitors are as follows.

Vout	C7
12V	25V 1,000μF × 4 parallel
24V	50V 820μF × 2 parallel
28V	50V 820μF × 2 parallel
48V	50V 1,000μF × 2 series, x 2 parallel

Table1-2 C7: Recommended Values of External Output Capacitor (Ta<-20°C)

3. Take note of the allowable ripple current of the capacitor to be used. Especially, when load adding capacitors for abrupt current changes, be sure to verify that ripple current does not exceed allowable ripple current before use.

C8:

When switches or connectors are used between input source and PAF450F280/PAF600F280 Series input terminals, impulse surge voltage is generated at input due to input throw-in by switch on/off or due to inserting/removing of power module from the active line. For this case, connect an additional electrolytic capacitor C8 as shown in fig.1-3 and fig. 1-4.

Recommended Capacitance Value: 10 - 47μF and above (Voltage Rating 400V and above)

Also, in-rush current flows at line throw-in. Therefore, be sure to verify capability of switch or fuse to withstand I²t at line throw-in.

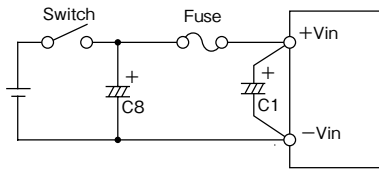

Fig.1-3 Input Filter with Input Switch

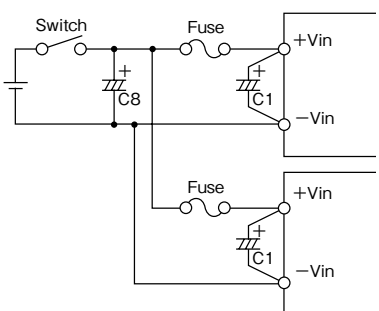

Fig.1-4 Input Filter when Plural Power

Reverse input connections

Reverse input polarity would cause module damage. For cases where reverse connections are possible, connect a protective diode and fuse. Use protective diode with higher voltage rating than the input voltage, and with higher surge current rating than the fuse.

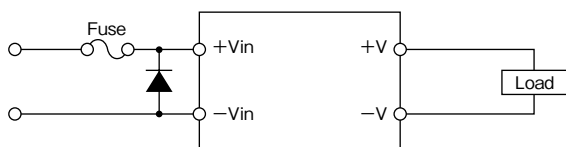

Fig.1-5 Protection for Reversed Connection of Input

Recommended input filter as EMI countermeasure (conforms to VCCI Class A, FCC class A)

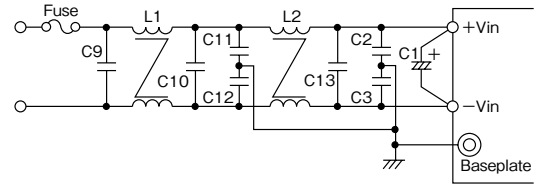

Fig.1-6 Recommended input filter as EMI countermeasure

Recommended Values:

- C1: 22 μ F (Electrolytic Capacitor)
- C2, C3, C11, C12: 680pF (Ceramic Capacitor)
- C9,C10,C13: 0.68 μ F (Film Capacitor)
- L1: 5 mH (Common mode choke coil)
- L2: 3.8 mH (Common mode choke coil)

- Note) 1. For the power module output, connect output capacitors described in the basic circuit connection.
2. VCCI Class A, FCC Class A limits can be satisfied with the above recommended filter at Densai-Lambda measuring conditions. However, there are cases where above limits might not be satisfied due to input and output wiring method, as well as, peripheral circuits. When selecting input filter, be sure to verify actual EMI characteristics (CE and RE) before finalizing the filter. Refer to PAF450F280-*/PAF600F280-* evaluation data for details.

PAF

2 Output Voltage Adjustment Range

Output voltage could be adjusted within the range described below by external resistor or variable resistor, or by applying external voltage. However, take note that OVP might trigger when output voltage adjustment exceeds the ranges indicated below.

Output Voltage Adjustment Range:

-40% to +20% of Nominal Output Voltage

Furthermore, when increasing the output voltage, reduce the output current so as not to exceed the maximum output power. Also, take note that when output voltage is increased, input voltage range is limited as shown in fig. 2-1.

With the external circuit as shown in fig.2-2, remote sensing is possible even when output voltage is varied. For details on remote sensing function, please refer to " 9. Remote Sensing"

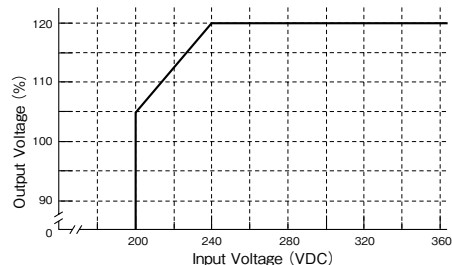

Fig.2-1 Limit of Input Voltage

Output Voltage Adjustment by external resistor or by variable resistor

Resistor values, as well as, connecting methods for external resistor (R1) and external variable resistor (VR) are described below.

In this case, using VR as remote programming resistor, remote programming of output voltage can be possible.

Also, be sure to connect remote programming resistor between +S terminal and +V terminal.

	12V	24V	28V	48V
R1	6.8k	6.8k	6.8k	6.8k
VR	20k	50k	50k	100k

Unit : [Ω]

External Resistor: Below ±5% Tolerance

Variable Resistor: Below ±20% Tolerance below 1% Remain

Table2-1 Values of External Resistor and Variable Resistor
-40% ~ +20% Variable

	12V	24V	28V	48V
R1	43k	43k	43k	43k
VR	5k	10k	10k	20k

Unit : [Ω]

External Resistor : Below ±5% Tolerance

Variable Resistor : Below ±20% Tolerance

Below 1% Remain

Table2-2 Values of External Resistor and Variable Resistor
±10% Variable

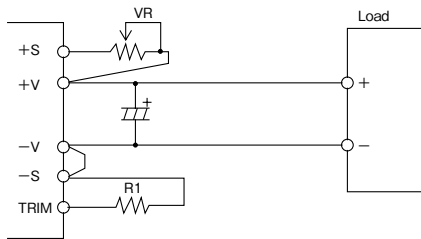

Fig.2-2 Example Connection of External Resistor

Output Voltage Adjustment by applying external voltage

By applying external voltage at the TRIM terminal, output voltage can be adjusted within the same output voltage adjustment range as the output voltage adjustment by external resistor or variable resistor. For this case, output voltage can be determined by the formula shown below.

$$\text{Output Voltage} = \text{TRIM Terminal Voltage} \times \text{Nominal Output Voltage}$$

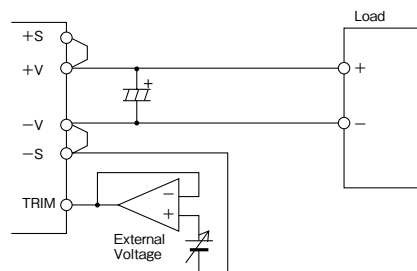

Fig.2-3 Output Voltage Adjustment by applying external voltage

For applications other than the above, refer to the trim circuit as shown in fig.2-4 and determine external circuit and component values.

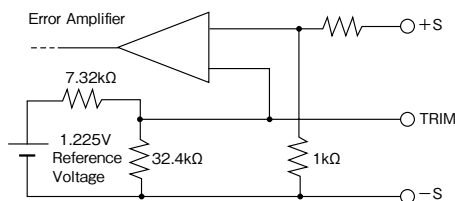

Fig.2-4 TRIM Circuit (For the Reference)

3 Maximum Output Ripple and Noise

Measured value according to the specified methods based on JEITA-9141 (Clause 7.12 and clause 7.13) which is described in the following.

Measure according to fig.3-1 connection, based on the basic connection of fig.1-2. Connect capacitors (C6: ceramic capacitor 2.2μF, C7: refer to table 1-1 for electrolytic capacitor values) at 50mm distance from the output terminals. Measure at ceramic capacitor (C6) leads as shown in fig.3-1 using coaxial cable with JEITA attachment. Use oscilloscope with 100MHz frequency bandwidth or equivalent.

Take note that output ripple voltage and output spike noise may vary depending on PCB wiring design.

Generally, output ripple voltage and output spike noise can be reduced by increasing capacitance value of external capacitor.

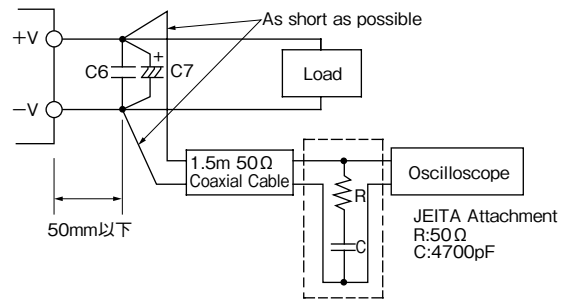

Fig.3-1 Measurement of Maximum Output Ripple & Noise

4 Maximum Line Regulation

Maximum value of output voltage change when input voltage is gradually varied (steady state) within specified input voltage range.

5 Maximum Load Regulation

Maximum value of output voltage change when output current is gradually varied (steady state) within specified output current range.

When using at dynamic load mode, audible noise could be heard from the power module and output voltage fluctuation might increase. A thorough pre-evaluation must be performed before using this power module.

6 Over Current Protection (OCP)

This power module has built-in OCP function.

Output will recover when short circuit or overload conditions are released. OCP setting value is fixed and therefore, cannot be externally adjusted.

Also, take note that power module might be damaged continuing output short circuit or over load conditions depending on thermal conditions.

7 Over Voltage Protection (OVP)

This power module has built-in OVP function.

OVP set point is relative to the rated output voltage value.

When OVP is triggered, output can be recovered by turning input line off and then turning it on again after input voltage drops down to 0V, or by manual reset of the control ON/OFF terminal. Reset time for ON/OFF terminal is 100ms or longer. When verifying OVP function by applying external voltage at the output terminals, applied voltage value should not exceed specified OVP maximum value. Refer to specification table for OVP maximum value. Avoid applying external voltage that exceeds OVP maximum value because this will cause power module damage.

OVP setting value is fixed and cannot be adjusted externally.

8 Over Thermal Protection (OTP)

This power module has built-in OTP function. This function operates and shuts down the output when ambient temperature or internal temperature of power module abnormally rises. OTP operates at 105°C to 130°C baseplate temperature..

When OTP is triggered, output can be recovered by turning input line off and then turning it on again after input voltage drops down to 0V, or by manual reset of the control ON/OFF terminal, after temperature sufficiently decreased. Reset time for ON/OFF terminal is 100ms or longer.

9 Remote Sensing (+S, -S terminal)

Remote sensing terminal is provided to compensate for voltage drop across the wirings from the power module output terminal to the load input terminal.

When remote sensing function is not used (local sensing), short +S terminal to +V terminal and, -S terminal to -V terminal.

Take note that voltage compensation range for line drop (voltage drop due to wiring) is determined such that output voltage at the output terminals is within output voltage range and that voltage between -V and -S terminals is within 2V or less. Even for remote sensing case, use power module such that output power is within specified maximum output power. Furthermore, reduce noise effect by using shield wire, twist pair, or parallel pattern.

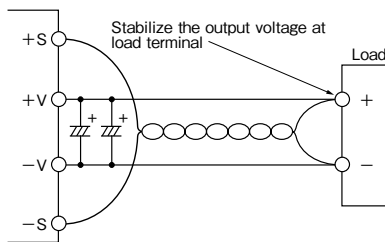

Fig.9-1 Remote Sensing at Use

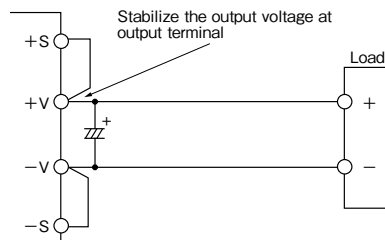

Fig.9-2 Remote Sensing Not in Use

10 ON/OFF Control (CNT, SG terminal)

Without turning the input supply on and off, the output can be enable and disabled using this function.

ON/OFF control circuit is on the input side (the primary side), and CNT terminal pin is used. Use the SG terminal as ground for CNT terminal.

If this function is not used, short the CNT terminal and the SG terminal.

- 1) The maximum impressed voltage for the CNT terminal is 35V and the maximum reverse voltage is 0.7V. Also the source current for CNT terminal is about 1mA. When wiring becomes long, connect a capacitor about 0.1μF value between the CNT and the SG terminal at a nearest distance.
- 2) ON/OFF terminal can be controlled by opening or closing connections (with switch or relay), or by photo-coupler ON/OFF. Also for the secondary control, isolation can be achieved through the use of a photo-coupler or equivalent.

* When using photo-coupler, connect between the CNT and the SG terminal to make transistor side shortest.

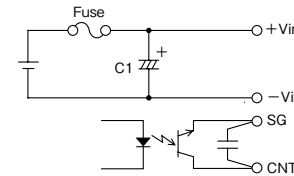

Fig.10-1 CNT, SG terminal connection

CNT Level	Output Status
H (4V and above) or Open	OFF
L (0.8V and below) or short	ON

Table 10-1 ON/OFF Control Mode

11 Parallel Operation (PC terminal)

By connecting the PC terminal of each power module, output current can be equally drawn from each module. A maximum of 11 units of the same model can be connected.

Furthermore, be sure that the output power of every module does not exceed the maximum output power value.

By setting output voltage accuracy of each module in a parallel operation to within ±1%, the maximum value of the output current that can be drawn is 95% of the total rated output current.

Refer to "Parallel Operation" of the Power Module Application Notes for details.

PAF

12 Series Operation

Series operation is possible for PAF450F280, PAF600F280 series. Connections shown fig.12-1 and fig.12-2 is possible

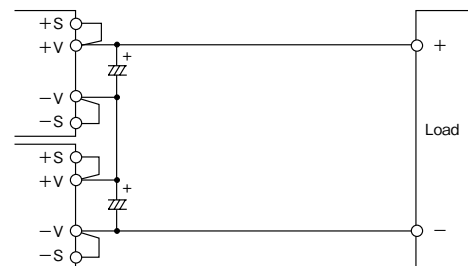

Fig.12-1 Series Operation in High Output Voltage

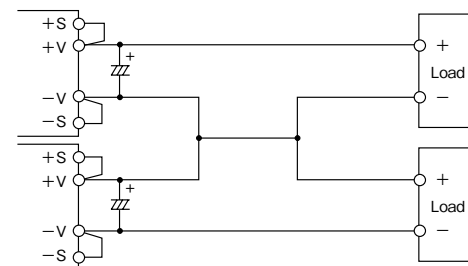

Fig.12-2 ±Output Series Operation

13 I.O.G. signal (IOG terminal)

Normal or abnormal operation of the power module can be monitored by using the IOG terminal. Output of this signal monitor is located at secondary side (output side) and is an open collector output.

This signal is LOW when inverter is normally operating and HIGH when inverter stops or when inverter is operating abnormally. (Maximum sink current is 5mA, maximum applied voltage is 35V.)

Ground for the IOG terminal is the S terminal.

Also note that IOG becomes unstable for following

conditions:

- Operation of Over Current Protection (OCP)
- Light load conditions at parallel operation
- Dynamic load operation

14 Auxiliary power supply for external signals (AUX terminal)

For AUX terminal, output voltage value is within 10 - 14 VDC range, maximum output current is 20mA. Ground for the AUX terminal is -S terminal.

Avoid short circuit of AUX terminal with other terminals as this would lead to power module damage.

15 Operating Ambient Temperature

There is no restriction on mounting direction but there should be enough consideration for airflow so that heat does not accumulate around the power module vicinity. Determine external components configuration and mounting direction on PCB such that air could flow through the heatsink at forced cooling and conventional cooling.

By maintaining actual baseplate temperature below 100°C, operation is possible.

For details on thermal design, refer to Application Notes "Thermal Design".

Note) 1. Maximum baseplate temperature is 100°C. For worst case operating condition, verify baseplate temperature at measurement point indicated in fig. 15-1.

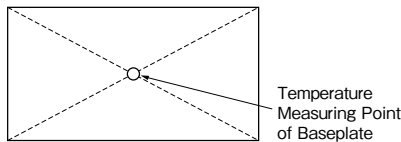

Fig.15-1 Temperature Measurement Point of Baseplate

2. There is limitation on baseplate temperature range for as shown in fig.15-2 and Fig.15-3.

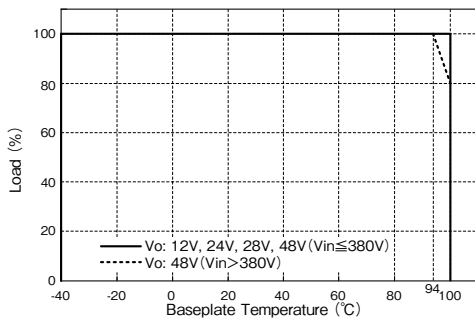

Fig.15-2 PAF450F280 Derating Curve

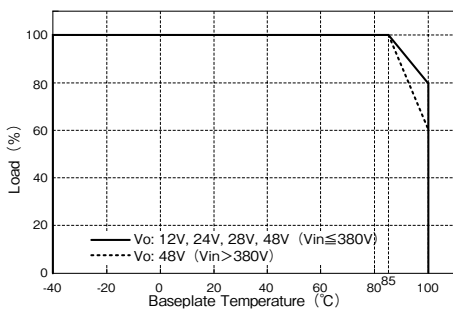

Fig.15-3 PAF600F280 Derating Curve

For better improvement of power module reliability, derating of baseplate temperature when using is recommended.

16 Operating Ambient Humidity

Take note that moisture could lead to power module abnormal operation or damage.

17 Storage Ambient Temperature

Abrupt temperature change would cause moisture formation that leads to poor solderability of each terminal of the power module.

18 Storage Ambient Humidity

Take enough care when storing the power module because rust which causes poor solderability would form in each terminal when stored in high temperature, high humidity environment.

19 Cooling Method

Operating temperature range is specified by the baseplate temperature. Therefore, several method of heat dissipation is possible.

For details on thermal design, refer to Application Notes "Thermal Design".

20 Baseplate Temperature vs. Output Voltage Drift

Output voltage drift is defined as the rate of voltage change when baseplate temperature only is changed during operation.

21 Withstand Voltage

This power module is designed to have a withstand voltage of 2.5kVAC between input and baseplate, and 3kVAC between input and output for 1 minute.

When conducting withstand voltage test during incoming inspection, be sure to set the current limit value of the withstand voltage testing equipment to 20mA.

This power module is designed to have a withstand value of 500VDC between output and baseplate for 1 minute. When conducting withstand voltage test during incoming inspection, be sure to apply DC voltage.

Be sure to avoid conducting test with AC voltage because this would cause power module damage.

Furthermore, avoid throw in or shut off of the testing equipment when applying or when shutting down the test voltage. Instead, gradually increase or decrease the applied voltage. Take note especially not to use the timer of the test equipment because when the timer switches the applied voltage off, impulse voltage which has several times the magnitude of the applied voltage is generated causing damage to the power module.

Connect the terminals as shown in fig.21-1, fig.21-2 and fig.21-3.

When conducting test by the basic connection shown in fig.1-2, connect the terminals similarly.

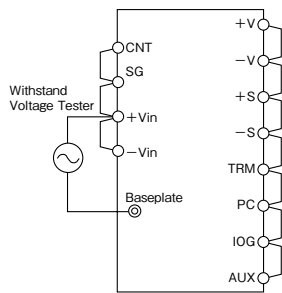

2.5kVAC 1minute (20mA)

Fig.21-1 Withstand Voltage Tester for Input-Baseplate

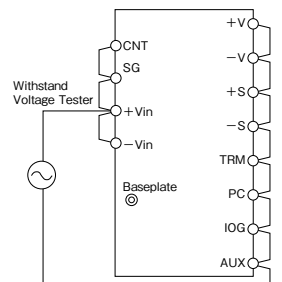

3kVAC 1minute (20mA)

Fig.21-2 Withstand Voltage Tester for Input-Output

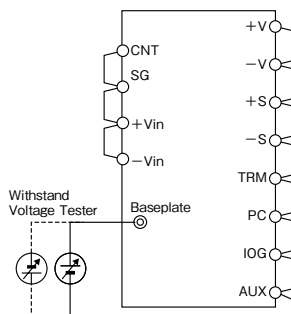

500VDC 1minute

Fig.21-3 Withstand Voltage Tester for Output-Baseplate

22 Insulation Resistance

Use DC insulation tester (MAX 500V) between output and baseplate. Insulation resistance value is 100MΩ and above at 500VDC applied voltage. Also take note that depending on the insulation tester used, some testers generate high voltage pulse. Discharge the power module after test using a resistor, etc.

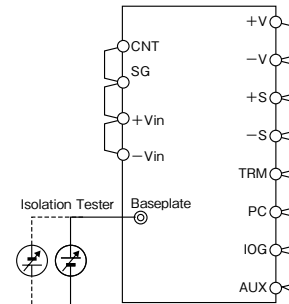
Over 100MΩ at 500VDC
Fig.22-1 Isolation Test

23 Withstand Vibration

Refer to Application Notes "Mounting Method" section.

24 Withstand Shock

Withstand shock value is defined to be the value at Den-sei Lambda shipment and packaging conditions.

3. Before concluding power module damage

Verify following items before concluding power module damage.

- 1) No output voltage
 - Is specified input voltage applied?
 - Are the ON/OFF control terminal (CNT, SG), remote sensing terminal (+S, -S), output voltage trimming terminal (TRIM) correctly connected?
 - Is output current of the auxiliary power supply for external signals terminal (AUX) within the specified value ?
 - For cases where output voltage adjustment is used, is the resistor or variable resistor setting, connections correctly done?
 - Are there no abnormalities in the output load used?
 - Is the baseplate temperature within the specified temperature range?
- 2) Output voltage is high
 - Are the remote sensing terminals (+S, -S) correctly connected?
 - Is the measurement done at the sensing points?
 - For cases where output voltage adjustment is used, is the resistor or volume setting, connections correctly done?
- 3) Output voltage is low
 - Is specified input voltage applied?
 - Are the remote sensing terminals (+S, -S) correctly connected?
 - Is the measurement done at the sensing points?
 - For cases where output voltage adjustment is used, is the resistor or variable resistor setting, connections correctly done?
 - Are there no abnormalities in the output load used?
- 4) Load regulation and line regulation is large
 - Is specified input voltage applied?
 - Are the input terminals and the output terminals firmly connected?
 - Is the measurement done at the sensing points?
 - Is the input or output wire too thin?
- 5) Output ripple voltage is large
 - Is the measuring method used the same or equivalent with the specified method in the Application Notes?
 - Is the input ripple voltage value within the specified value?