

Converter - Brake - Inverter Module (CBI2)

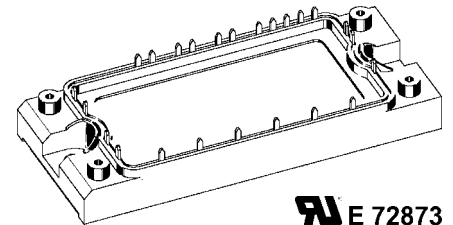
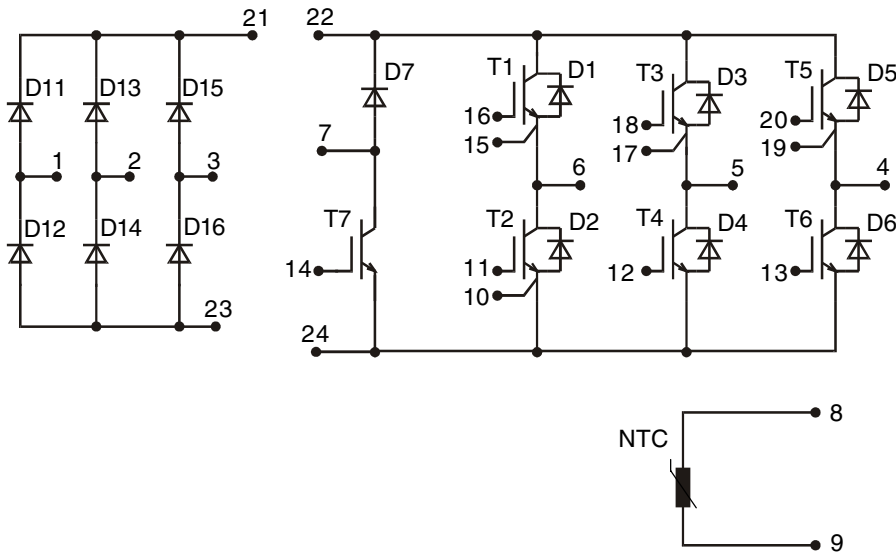

E 72873

Three Phase Rectifier	Brake Chopper	Three Phase Inverter
$V_{RRM} = 1600V$	$V_{CES} = 1200 V$	$V_{CES} = 1200 V$
$I_{DAVM} = 36 A$	$I_{C25} = 20 A$	$I_{C25} = 35 A$
$I_{FSM} = 300 A$	$V_{CE(sat)} = 2.3 V$	$V_{CE(sat)} = 2.1 V$

Input Rectifier Bridge D11 - D16

Symbol	Conditions	Maximum Ratings	
V_{RRM}		1600	V
I_{FAV}	$T_C = 80^\circ C$; sine 180°	25	A
I_{DAVM}	$T_C = 80^\circ C$; rectangular; $d = 1/3$	24	A
I_{FSM}	$T_{VJ} = 25^\circ C$; $t = 10$ ms; sine 50 Hz	300	A
P_{tot}	$T_C = 25^\circ C$	100	W

Symbol	Conditions	Characteristic Values ($T_{VJ} = 25^\circ C$, unless otherwise specified)		
		min.	typ.	max.
V_F	$I_F = 15 A$; $T_{VJ} = 25^\circ C$ $T_{VJ} = 125^\circ C$		1.3 1.3	1.6 V V
I_R	$V_R = V_{RRM}$; $T_{VJ} = 25^\circ C$ $T_{VJ} = 125^\circ C$		1.2	0.15 mA mA
t_{rr}	$V_R = 100 V$; $I_F = 15 A$; $di/dt = -15 A/\mu s$		1	μs
R_{thJC}	(per diode)			1.3 K/W

Application: AC motor drives with

- Input from single or three phase grid
- Three phase synchronous or asynchronous motor
- electric braking operation

Features

- High level of integration - only one power semiconductor module required for the whole drive
- Fast rectifier diodes for enhanced EMC behaviour
- NPT IGBT technology with low saturation voltage, low switching losses, high RBSOA and short circuit ruggedness
- Epitaxial free wheeling diodes with Hiperfast and soft reverse recovery
- Industry standard package with insulated copper base plate and soldering pins for PCB mounting
- Temperature sense included

Output Inverter T1 - T6

Symbol	Conditions	Maximum Ratings	
V_{CES}	$T_{VJ} = 25^{\circ}\text{C}$ to 150°C	1200	V
V_{GES}	Continuous	± 20	V
V_{GEM}	Transient	± 30	V
I_{C25}	$T_C = 25^{\circ}\text{C}$	35	A
I_{C80}	$T_C = 80^{\circ}\text{C}$	25	A
RBSOA	$V_{GE} = \pm 15\text{ V}$; $R_G = 82\ \Omega$; $T_{VJ} = 125^{\circ}\text{C}$ Clamped inductive load; $L = 100\ \mu\text{H}$	$I_{CM} = 35$ $V_{CEK} \leq V_{CES}$	A
t_{SC} (SCSOA)	$V_{CE} = V_{CES}$; $V_{GE} = \pm 15\text{ V}$; $R_G = 82\ \Omega$; $T_{VJ} = 125^{\circ}\text{C}$ non-repetitive	10	μs
P_{tot}	$T_C = 25^{\circ}\text{C}$	180	W

Symbol	Conditions	Characteristic Values ($T_{VJ} = 25^{\circ}\text{C}$, unless otherwise specified)		
		min.	typ.	max.
$V_{CE(sat)}$	$I_C = 15\text{ A}$; $V_{GE} = 15\text{ V}$; $T_{VJ} = 25^{\circ}\text{C}$ $T_{VJ} = 125^{\circ}\text{C}$	2.1 2.3	2.6	V V
$V_{GE(th)}$	$I_C = 0.6\text{ mA}$; $V_{GE} = V_{CE}$	4.5	6.5	V
I_{CES}	$V_{CE} = V_{CES}$; $V_{GE} = 0\text{ V}$; $T_{VJ} = 25^{\circ}\text{C}$ $T_{VJ} = 125^{\circ}\text{C}$	0.9	0.9	mA mA
I_{GES}	$V_{CE} = 0\text{ V}$; $V_{GE} = \pm 20\text{ V}$		200	nA
$t_{d(on)}$ t_r $t_{d(off)}$ t_f E_{on} E_{off}	Inductive load, $T_{VJ} = 125^{\circ}\text{C}$ $V_{CE} = 600\text{ V}$; $I_C = 15\text{ A}$ $V_{GE} = \pm 15\text{ V}$; $R_G = 82\ \Omega$	100		ns
		70		ns
		500		ns
		70		ns
		2.3		mJ
		1.8		mJ
C_{ies}	$V_{CE} = 25\text{ V}$; $V_{GE} = 0\text{ V}$; $f = 1\text{ MHz}$	1000		pF
Q_{Gon}	$V_{CE} = 600\text{ V}$; $V_{GE} = 15\text{ V}$; $I_C = 15\text{ A}$	70		nC
R_{thJC}	(per IGBT)		0.7	K/W

Output Inverter D1 - D6

Symbol	Conditions	Maximum Ratings	
I_{F25}	$T_C = 25^{\circ}\text{C}$	28	A
I_{F80}	$T_C = 80^{\circ}\text{C}$	18	A

Symbol	Conditions	Characteristic Values		
		min.	typ.	max.
V_F	$I_F = 15\text{ A}$; $V_{GE} = 0\text{ V}$; $T_{VJ} = 25^{\circ}\text{C}$ $T_{VJ} = 125^{\circ}\text{C}$		1.8	2.7 V V
I_{RM} t_{rr}	$I_F = 15\text{ A}$; $di_F/dt = -400\text{ A}/\mu\text{s}$; $T_{VJ} = 125^{\circ}\text{C}$ $V_R = 600\text{ V}$; $V_{GE} = 0\text{ V}$		16	A
			130	ns
R_{thJC}	(per diode)			2.1 K/W

Equivalent Circuits for Simulation
Conduction

D11 - D16

Rectifier Diode (typ. at $T_J = 125^{\circ}\text{C}$)
 $V_0 = 1.08\text{ V}$; $R_0 = 15\text{ m}\Omega$

T1 - T6 / D1 - D6

IGBT (typ. at $V_{GE} = 15\text{ V}$; $T_J = 125^{\circ}\text{C}$)
 $V_0 = 1.37\text{ V}$; $R_0 = 62\text{ m}\Omega$

Free Wheeling Diode (typ. at $T_J = 125^{\circ}\text{C}$)
 $V_0 = 1.32\text{ V}$; $R_0 = 30\text{ m}\Omega$

T7 / D7

IGBT (typ. at $V_{GE} = 15\text{ V}$; $T_J = 125^{\circ}\text{C}$)
 $V_0 = 1.32\text{ V}$; $R_0 = 131\text{ m}\Omega$

Free Wheeling Diode (typ. at $T_J = 125^{\circ}\text{C}$)
 $V_0 = 1.39\text{ V}$; $R_0 = 56\text{ m}\Omega$

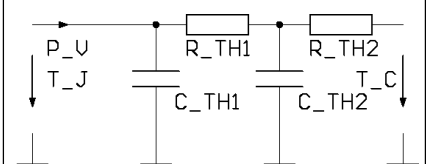
Thermal Response

D11 - D16

Rectifier Diode (typ.)
 $C_{th1} = 0.106\text{ J/K}$; $R_{th1} = 1.06\text{ K/W}$
 $C_{th2} = 0.79\text{ J/K}$; $R_{th2} = 0.239\text{ K/W}$

T1 - T6 / D1 - D6

IGBT (typ.)
 $C_{th1} = 0.156\text{ J/K}$; $R_{th1} = 0.545\text{ K/W}$
 $C_{th2} = 1.162\text{ J/K}$; $R_{th2} = 0.155\text{ K/W}$

Free Wheeling Diode (typ.)
 $C_{th1} = 0.065\text{ J/K}$; $R_{th1} = 1.758\text{ K/W}$
 $C_{th2} = 0.639\text{ J/K}$; $R_{th2} = 0.342\text{ K/W}$

T7 / D7

IGBT (typ.)
 $C_{th1} = 0.09\text{ J/K}$; $R_{th1} = 0.954\text{ K/W}$
 $C_{th2} = 0.809\text{ J/K}$; $R_{th2} = 0.246\text{ K/W}$

Free Wheeling Diode (typ.)
 $C_{th1} = 0.043\text{ J/K}$; $R_{th1} = 2.738\text{ K/W}$
 $C_{th2} = 0.54\text{ J/K}$; $R_{th2} = 0.462\text{ K/W}$

Brake Chopper T7

Symbol	Conditions	Maximum Ratings	
V_{CES}	$T_{VJ} = 25^{\circ}\text{C}$ to 150°C	1200	V
V_{GES}	Continuous	± 20	V
V_{GEM}	Transient	± 30	V
I_{C25}	$T_C = 25^{\circ}\text{C}$	20	A
I_{C80}	$T_C = 80^{\circ}\text{C}$	15	A
RBSOA	$V_{GE} = \pm 15\text{ V}$; $R_G = 82\ \Omega$; $T_{VJ} = 125^{\circ}\text{C}$ Clamped inductive load; $L = 100\ \mu\text{H}$	$I_{CM} = 20$ $V_{CEK} \leq V_{CES}$	A
t_{SC} (SCSOA)	$V_{CE} = 720\text{ V}$; $V_{GE} = \pm 15\text{ V}$; $R_G = 82\ \Omega$; $T_{VJ} = 125^{\circ}\text{C}$ non-repetitive	10	μs
P_{tot}	$T_C = 25^{\circ}\text{C}$	105	W

Symbol	Conditions	Characteristic Values		
		$(T_{VJ} = 25^{\circ}\text{C}$, unless otherwise specified)		
		min.	typ.	max.
$V_{CE(sat)}$	$I_C = 10\text{ A}$; $V_{GE} = 15\text{ V}$; $T_{VJ} = 25^{\circ}\text{C}$ $T_{VJ} = 125^{\circ}\text{C}$		2.3 2.7	2.7 V V
$V_{GE(th)}$	$I_C = 0.4\text{ mA}$; $V_{GE} = V_{CE}$	4.5		6.5 V
I_{CES}	$V_{CE} = V_{CES}$; $V_{GE} = 0\text{ V}$; $T_{VJ} = 25^{\circ}\text{C}$ $T_{VJ} = 125^{\circ}\text{C}$		0.3	0.5 mA mA
I_{GES}	$V_{CE} = 0\text{ V}$; $V_{GE} = \pm 20\text{ V}$			200 nA
$t_{d(on)}$ t_r $t_{d(off)}$ t_f E_{on} E_{off}	Inductive load, $T_{VJ} = 125^{\circ}\text{C}$ $V_{CE} = 600\text{ V}$; $I_C = 10\text{ A}$ $V_{GE} = \pm 15\text{ V}$; $R_G = 82\ \Omega$		50 40 290 60 1.2 1.1	ns ns ns ns mJ mJ
C_{ies}		$V_{CE} = 25\text{ V}$; $V_{GE} = 0\text{ V}$; $f = 1\text{ MHz}$	600	pF
Q_{Gon}		$V_{CE} = 600\text{ V}$; $V_{GE} = 15\text{ V}$; $I_C = 10\text{ A}$	45	nC
R_{thJC}				1.2 K/W

Brake Chopper D7

Symbol	Conditions	Maximum Ratings	
V_{RRM}	$T_{VJ} = 25^{\circ}\text{C}$ to 150°C	1200	V
I_{F25}	$T_C = 25^{\circ}\text{C}$	17	A
I_{F80}	$T_C = 80^{\circ}\text{C}$	11	A

Symbol	Conditions	Characteristic Values		
		min.	typ.	max.
V_F	$I_F = 10\text{ A}$; $T_{VJ} = 25^{\circ}\text{C}$ $T_{VJ} = 125^{\circ}\text{C}$		1.9	2.9 V V
I_R	$V_R = V_{RRM}$; $T_{VJ} = 25^{\circ}\text{C}$ $T_{VJ} = 125^{\circ}\text{C}$		0.07	0.06 mA mA
I_{RM} t_{rr}	$I_F = 10\text{ A}$; $di_F/dt = -400\text{ A}/\mu\text{s}$; $T_{VJ} = 125^{\circ}\text{C}$ $V_R = 600\text{ V}$		13 110	A ns
R_{thJC}				3.2 K/W

Temperature Sensor NTC

Symbol	Conditions	Characteristic Values		
		min.	typ.	max.
R_{25}	$T = 25^{\circ}\text{C}$	4.75	5.0	5.25 k Ω
$B_{25/50}$			3375	K

Module

Symbol	Conditions	Maximum Ratings	
T_{VJ}	Operating	-40...+125	$^{\circ}\text{C}$
T_{JM}		150	$^{\circ}\text{C}$
T_{stg}		-40...+125	$^{\circ}\text{C}$
V_{ISOL}	$I_{ISOL} \leq 1 \text{ mA}; 50/60 \text{ Hz}$	2500	V~
M_d	Mounting torque (M5)	2.7 - 3.3	Nm

Symbol	Conditions	Characteristic Values		
		min.	typ.	max.
$R_{pin-chip}$			5	m Ω
d_s	Creepage distance on surface	6		mm
d_A	Strike distance in air	6		mm
R_{thCH}	with heatsink compound		0.02	K/W
Weight			180	g

Dimensions in mm (1 mm = 0.0394")

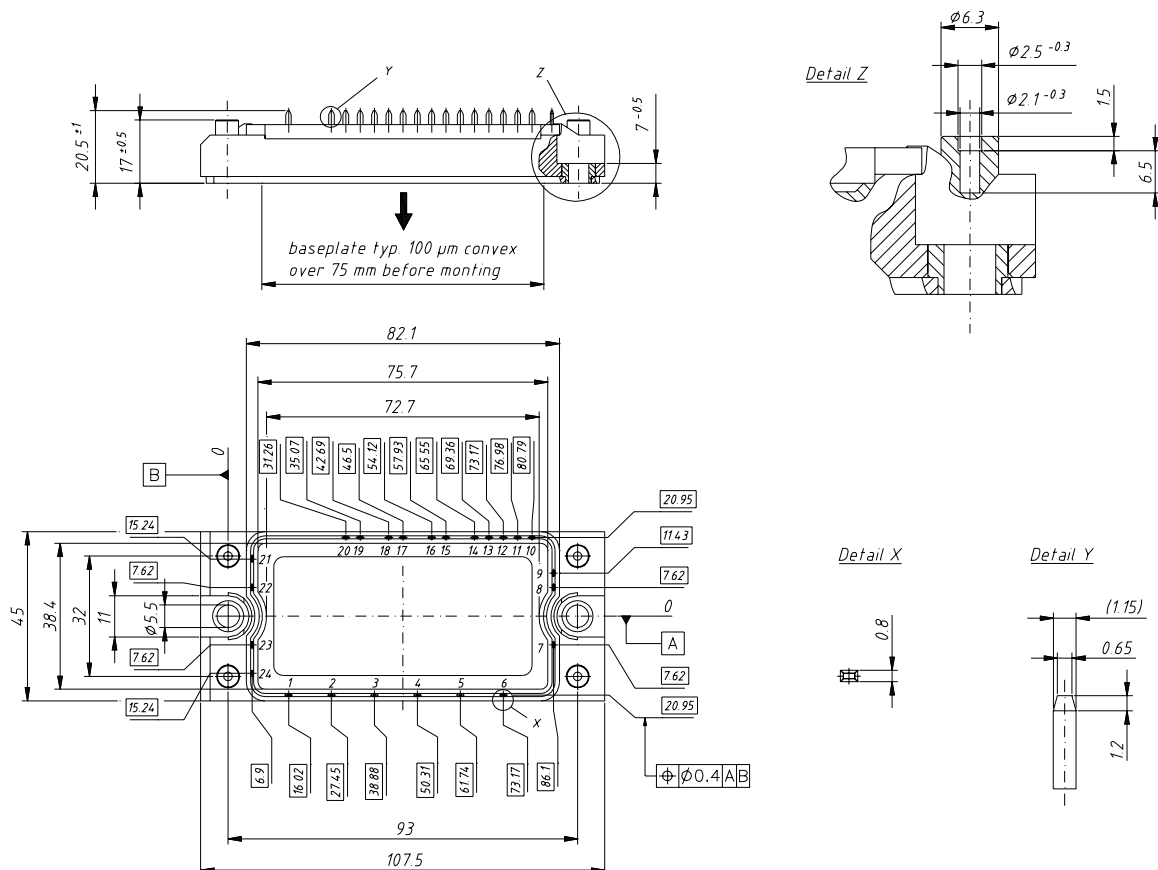

Input Rectifier Bridge D11 - D16

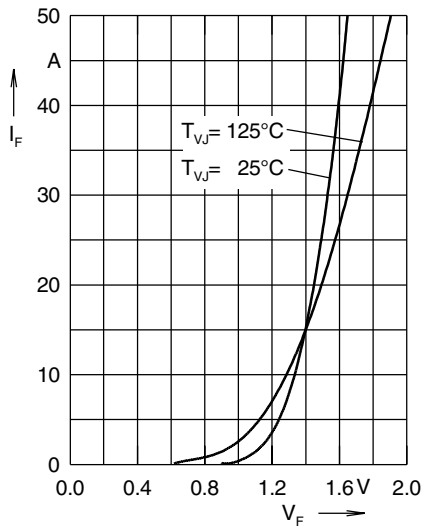

Fig. 1 Forward current versus voltage drop per diode

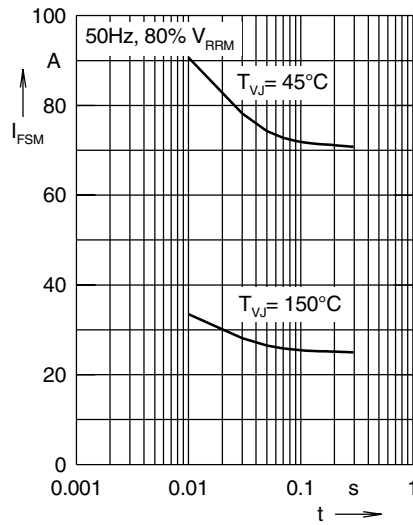

Fig. 2 Surge overload current

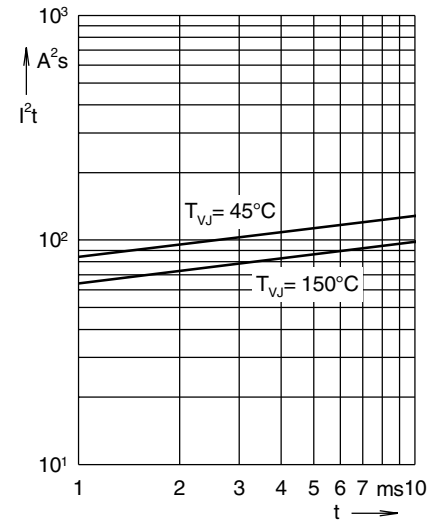

Fig. 3 I²t versus time per diode

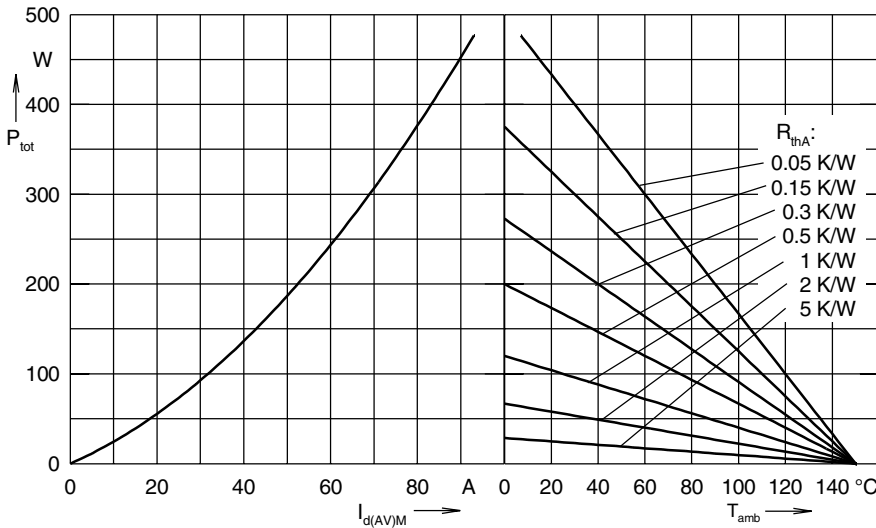

Fig. 4 Power dissipation versus direct output current and ambient temperature, sin 1/8

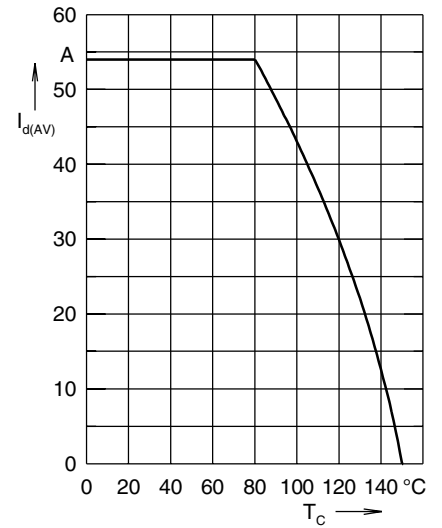

Fig. 5 Max. forward current versus case temperature

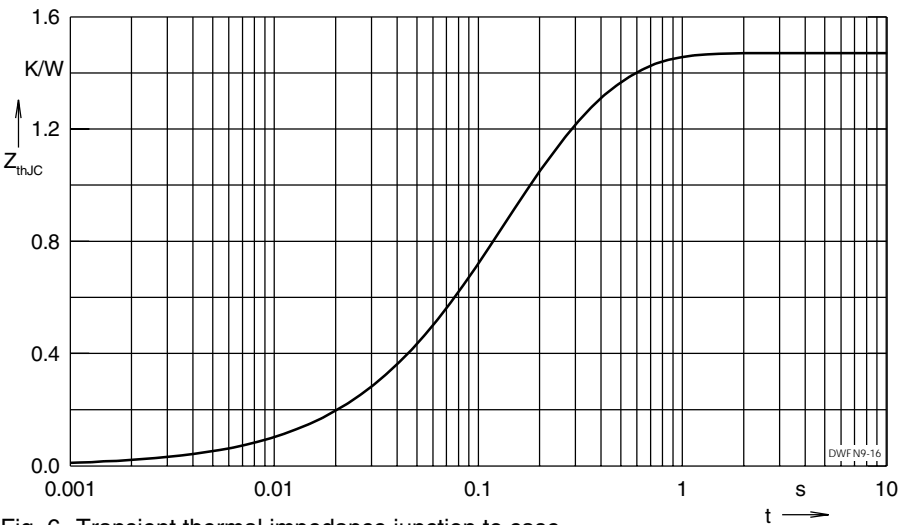

Fig. 6 Transient thermal impedance junction to case

Output Inverter T1 - T6 / D1 - D6

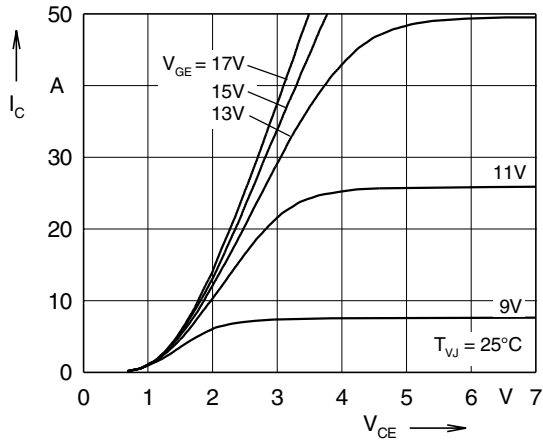

Fig. 7 Typ. output characteristics

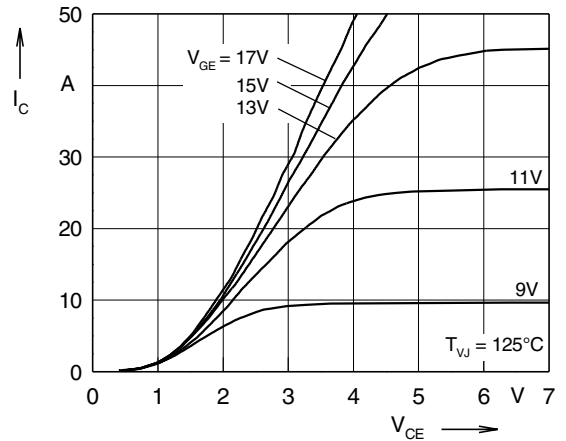

Fig. 8 Typ. output characteristics

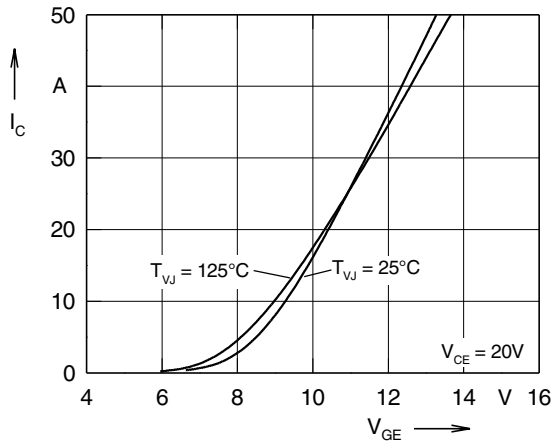

Fig. 9 Typ. transfer characteristics

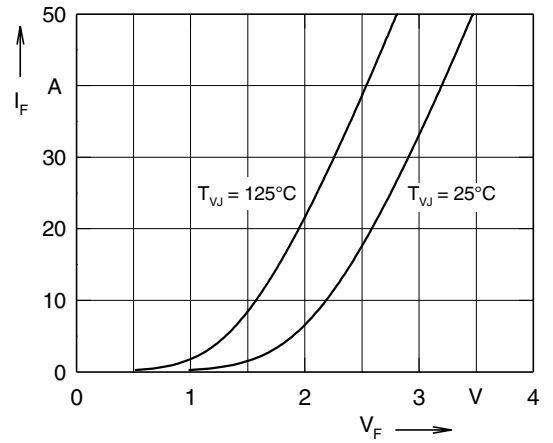

Fig. 10 Typ. forward characteristics of free wheeling diode

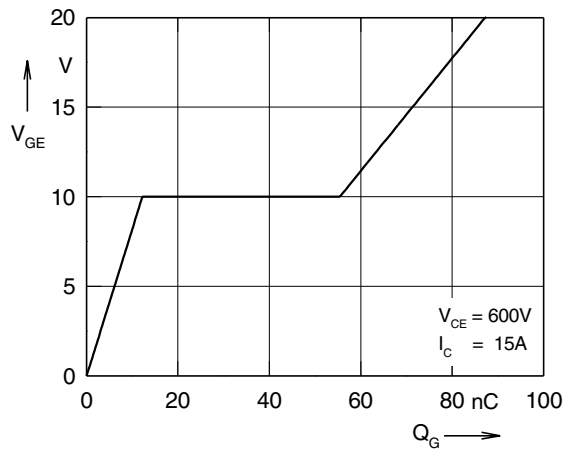

Fig. 11 Typ. turn on gate charge

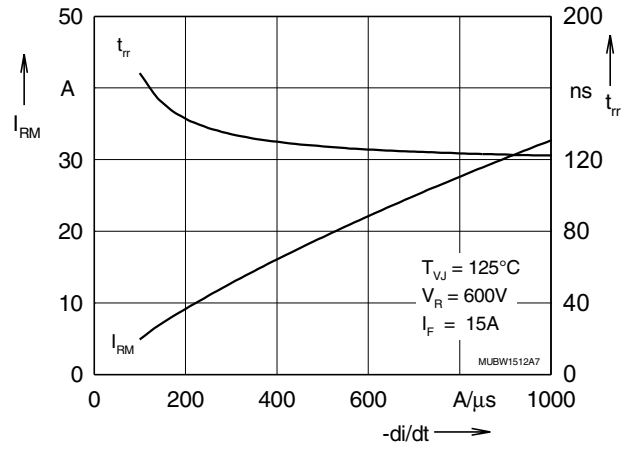

Fig. 12 Typ. turn off characteristics of free wheeling diode

Output Inverter T1 - T6 / D1 - D6

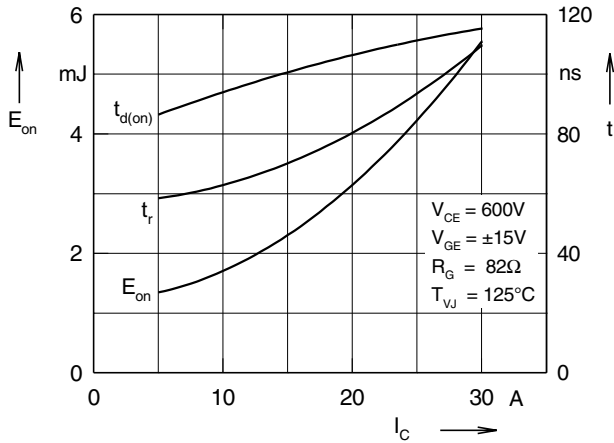

Fig. 13 Typ. turn on energy and switching times versus collector current

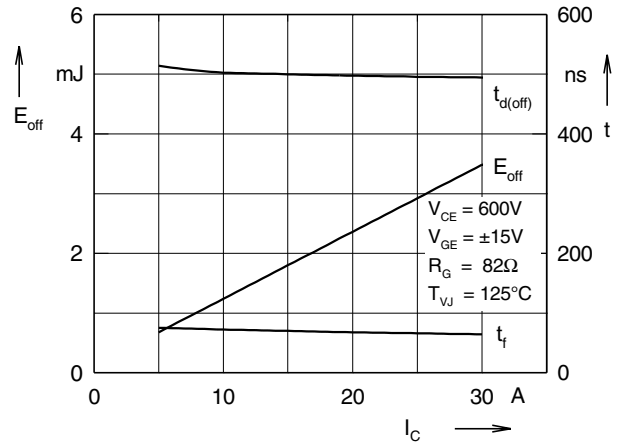

Fig. 14 Typ. turn off energy and switching times versus collector current

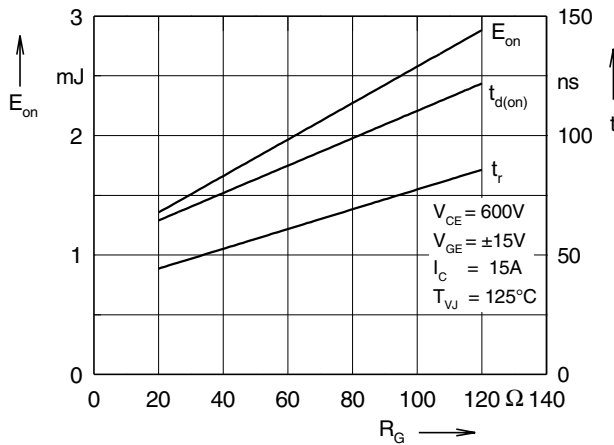

Fig. 15 Typ. turn on energy and switching times versus gate resistor

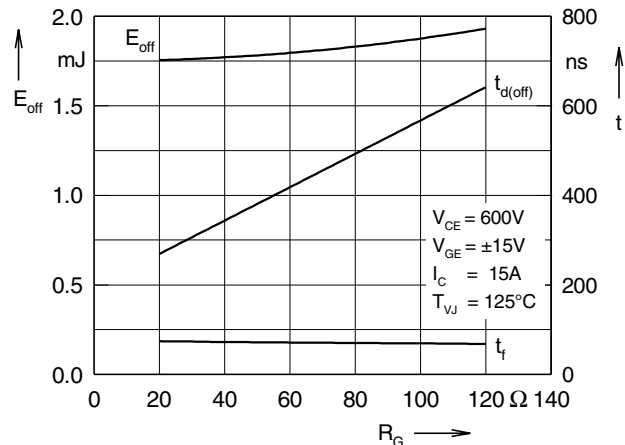

Fig. 16 Typ. turn off energy and switching times versus gate resistor

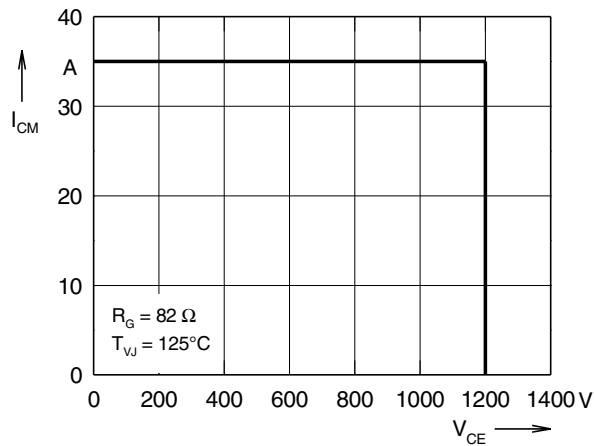

Fig. 17 Reverse biased safe operating area RBSOA

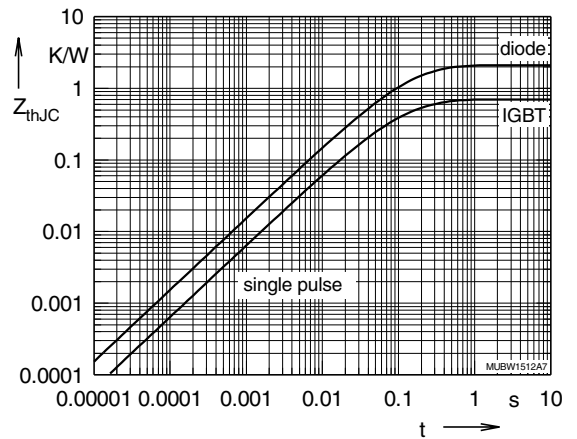

Fig. 18 Typ. transient thermal impedance

Brake Chopper T7 / D7

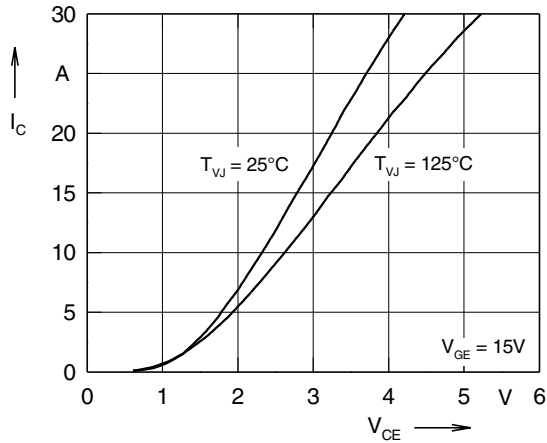

Fig. 19 Typ. output characteristics

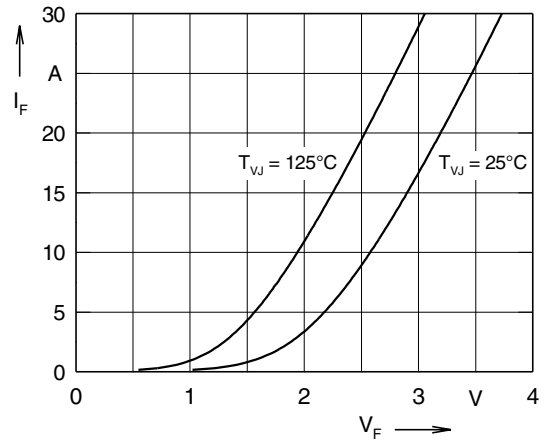

Fig. 20 Typ. forward characteristics of free wheeling diode

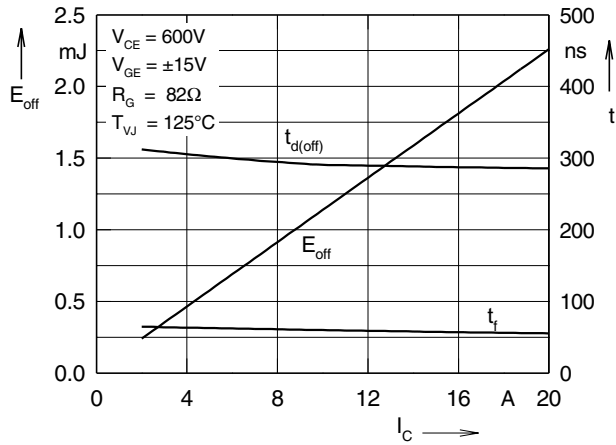

Fig. 21 Typ. turn off energy and switching times versus collector current

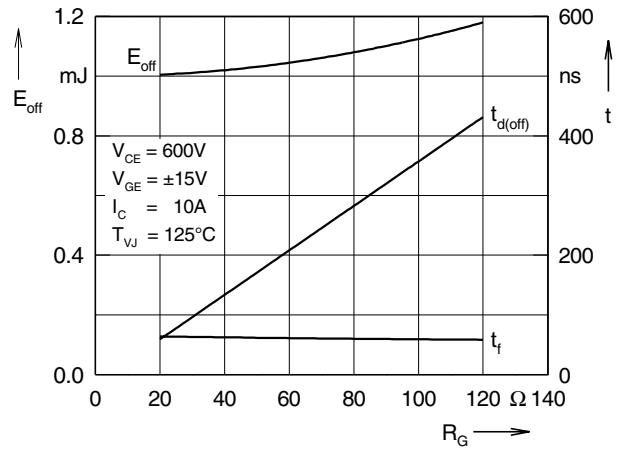

Fig. 22 Typ. turn off energy and switching times versus gate resistor

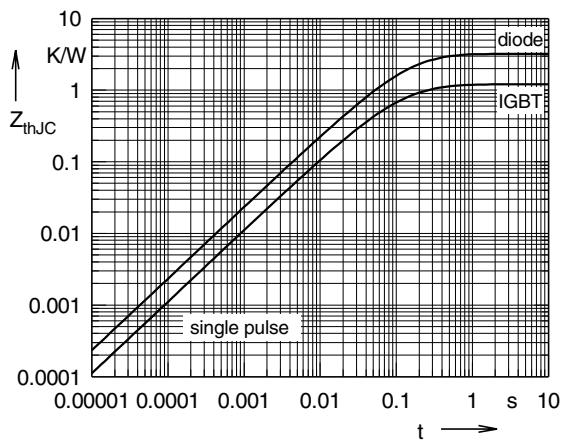

Fig. 23 Typ. transient thermal impedance

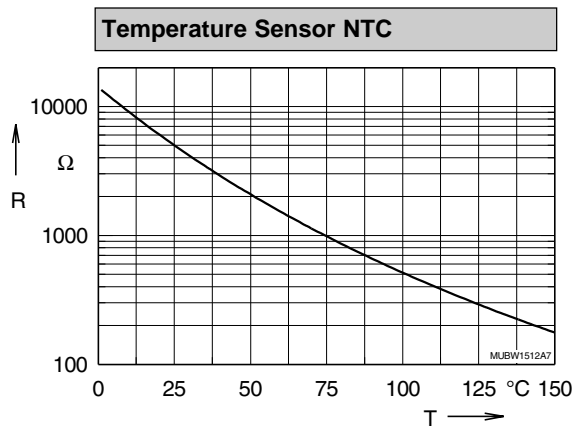

Fig. 24 Typ. thermistorresistance versus temperature