

TOSHIBA INTELLIGENT GTR MODULE SILICON N CHANNEL IGBT

# MIG75J201H

HIGH POWER SWITCHING APPLICATIONS

MOTOR CONTROL APPLICATIONS

- Integrates Inverter, Brake Power Circuits & Control Circuits (IGBT drive units, Protection units for Over-Current, Under-Voltage & Over-Temperature) in One Package.
- The Electrodes are Isolated from Case.
- High Speed Type IGBT :  $V_{CE(sat)}=2.5V$  (Max.)  
 $t_{off}=3.0\mu s$  (Max.)  
 $t_{rr}=0.30\mu s$  (Max.)
- Outline : TOSHIBA 2-110A1A
- Weight : 520g

EQUIVALENT CIRCUIT

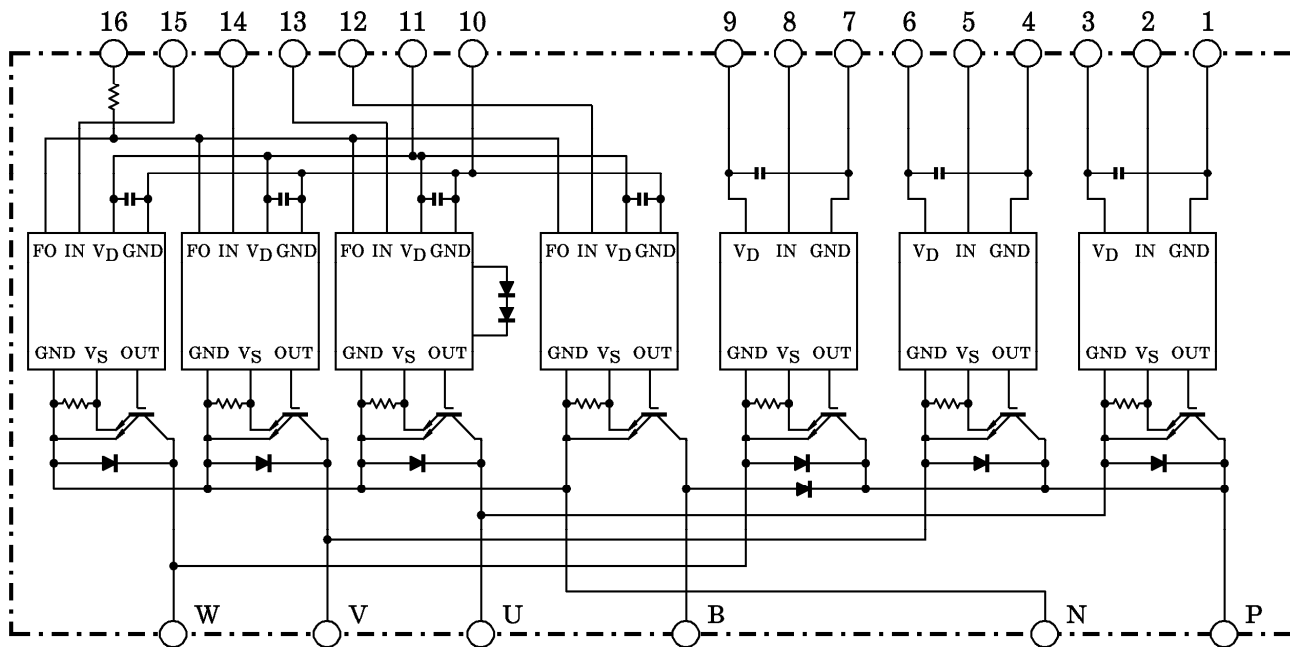

- |            |            |                       |             |                        |                       |
|------------|------------|-----------------------|-------------|------------------------|-----------------------|
| 1. GND (U) | 2. IN (U)  | 3. V <sub>D</sub> (U) | 4. GND (V)  | 5. IN (V)              | 6. V <sub>D</sub> (V) |
| 7. GND (W) | 8. IN (W)  | 9. V <sub>D</sub> (W) | 10. GND (L) | 11. V <sub>D</sub> (L) | 12. IN (B)            |
| 13. IN (X) | 14. IN (Y) | 15. IN (Z)            | 16. FO      |                        |                       |

961001FAA1

● TOSHIBA is continually working to improve the quality and the reliability of its products. Nevertheless, semiconductor devices in general can malfunction or fail due to their inherent electrical sensitivity and vulnerability to physical stress. It is the responsibility of the buyer, when utilizing TOSHIBA products, to observe standards of safety, and to avoid situations in which a malfunction or failure of a TOSHIBA product could cause loss of human life, bodily injury or damage to property. In developing your designs, please ensure that TOSHIBA products are used within specified operating ranges as set forth in the most recent products specifications. Also, please keep in mind the precautions and conditions set forth in the TOSHIBA Semiconductor Reliability Handbook.

● The information contained herein is presented only as a guide for the applications of our products. No responsibility is assumed by TOSHIBA CORPORATION for any infringements of intellectual property or other rights of the third parties which may result from its use. No license is granted by implication or otherwise under any intellectual property or other rights of TOSHIBA CORPORATION or others.

● The information contained herein is subject to change without notice.

MAXIMUM RATINGS ( $T_j = 25^\circ\text{C}$ )

STAGE	CHARACTERISTIC	CONDITION	SYMBOL	RATINGS	UNIT
Inverter	Supply Voltage	P-N power terminal	$V_{CC}$	450	V
	Collector-Emitter Voltage	—	$V_{CES}$	600	V
	Collector Current	$T_c = 25^\circ\text{C}$ , DC	$I_C$	75	A
	Forward Current	$T_c = 25^\circ\text{C}$ , DC	$I_F$	75	A
	Collector Power Dissipation	$T_c = 25^\circ\text{C}$	$P_C$	195	W
	Junction Temperature	—	$T_j$	150	$^\circ\text{C}$
Brake	Supply Voltage	P-N power terminal	$V_{CC}$	450	V
	Collector-Emitter Voltage	—	$V_{CES}$	600	V
	Collector Current	$T_c = 25^\circ\text{C}$ , DC	$I_C$	30	A
	Reverse Voltage	—	$V_R$	600	V
	Forward Current	$T_c = 25^\circ\text{C}$ , DC	$I_F$	30	A
	Collector Power Dissipation	$T_c = 25^\circ\text{C}$	$P_C$	80	W
	Junction Temperature	—	$T_j$	150	$^\circ\text{C}$
Control	Control Supply Voltage	$V_D$ -GND terminal	$V_D$	20	V
	Input Voltage	IN-GND terminal	$V_{IN}$	20	V
	Fault Output Voltage	FO-GND (L) terminal	$V_{FO}$	20	V
	Fault Output Current	FO sink current	$I_{FO}$	14	mA
Module	Operating Temperature	—	$T_C$	$-20 \sim +100$	$^\circ\text{C}$
	Storage Temperature Range	—	$T_{stg}$	$-40 \sim +125$	$^\circ\text{C}$
	Isolation Voltage	AC 1 minute	$V_{ISO}$	2500	V
	Screw Torque	M5	—	3	Nm

ELECTRICAL CHARACTERISTICS ( $T_j = 25^\circ\text{C}$ )

a. Inverter stage

CHARACTERISTIC	SYMBOL	TEST CONDITION	MIN.	TYP.	MAX.	UNIT	
Collector Cut-Off Current	$I_{CEX}$	$V_{CEX} = 600\text{V}$	$T_j = 25^\circ\text{C}$	—	—	1	mA
			$T_j = 125^\circ\text{C}$	—	—	20	
Collector-Emitter Saturation Voltage	$V_{CE}(\text{sat})$	$V_D = 15\text{V}$ , $I_C = 75\text{A}$ $V_{IN} = 15\text{V} \rightarrow 0\text{V}$	$T_j = 25^\circ\text{C}$	—	2.0	2.5	V
			$T_j = 125^\circ\text{C}$	—	2.0	—	
Forward Voltage	$V_F$	$I_F = 75\text{A}$	—	2.1	3.0	V	
Switching Time	$t_{on}$	$V_{CC} = 300\text{V}$ , $I_C = 75\text{A}$ $V_D = 15\text{V}$ , $V_{IN} = 15\text{V} \leftrightarrow 0\text{V}$ Inductive load (Note 1)	—	1.0	2.0	$\mu\text{s}$	
	$t_{off}$		—	1.2	3.0		
	$t_f$		—	0.2	0.5		
	$t_{rr}$		—	0.1	0.3		

b. Brake stage

CHARACTERISTIC	SYMBOL	TEST CONDITION	MIN.	TYP.	MAX.	UNIT	
Collector Cut-Off Current	I <sub>CEX</sub>	V <sub>CEX</sub> = 600V	T <sub>j</sub> = 25°C	—	—	1	mA
			T <sub>j</sub> = 125°C	—	—	20	
Collector-Emitter Saturation Voltage	V <sub>CE (sat)</sub>	V <sub>D</sub> = 15V, I <sub>C</sub> = 30A V <sub>IN</sub> = 15V → 0V	T <sub>j</sub> = 25°C	—	1.7	2.7	V
			T <sub>j</sub> = 125°C	—	1.6	—	
Reverse Current	I <sub>R</sub>	V <sub>R</sub> = 600V	T <sub>j</sub> = 25°C	—	—	1	mA
			T <sub>j</sub> = 125°C	—	—	20	
Forward Voltage	V <sub>F</sub>	I <sub>F</sub> = 30A	—	2.0	2.5	V	
Switching Time	t <sub>on</sub>	V <sub>CC</sub> = 300V, I <sub>C</sub> = 30A	—	0.9	2.0	μs	
	t <sub>off</sub>	V <sub>D</sub> = 15V, V <sub>IN</sub> = 15V ↔ 0V	—	1.7	3.0		
	t <sub>f</sub>	Inductive load	—	0.25	0.5		
	t <sub>rr</sub>	(Note 1)	—	0.15	0.3		

c. Control stage (T<sub>j</sub> = 25°C)

CHARACTERISTIC	SYMBOL	TEST CONDITION	MIN.	TYP.	MAX.	UNIT	
Control Circuit Current	High Side	I <sub>D</sub> (H)	V <sub>D</sub> = 15V	—	8	—	mA
	Low Side			I <sub>D</sub> (L)	—	32	
Input-On Signal Voltage	V <sub>IN (on)</sub>	V <sub>D</sub> = 15V, I <sub>C</sub> = 75mA	1.3	1.5	1.7	V	
Input-Off Signal Voltage	V <sub>IN (off)</sub>	V <sub>D</sub> = 15V, I <sub>C</sub> = 75mA	2.2	2.5	2.8	V	
Fault Output Current	Protection	I <sub>FO (on)</sub>	V <sub>D</sub> = 15V	8	10	12	mA
	Normal			I <sub>FO (off)</sub>	—	—	
Over Current Protection Trip Level	Inverter	OC	V <sub>D</sub> = 15V, T <sub>j</sub> = 125°C	105	150	—	A
	Brake			40	—	—	
Short Circuit Protection Trip Level	Inverter	SC	V <sub>D</sub> = 15V, T <sub>j</sub> = 125°C	157	225	—	A
	Brake			60	—	—	
Over Current Cut-Off Time	t <sub>off (OC)</sub>	V <sub>D</sub> = 15V	—	5	—	μs	
Over Temperature Protection	Trip Level	OT	Case temperature	110	118	125	°C
	Reset Level			OTr	—	98	
Control Supply Under Voltage Protection	Trip Level	UV	—	11.0	12.0	12.5	V
	Reset Level			UVr	—	12.5	
Fault Output Pulse Width	t <sub>FO</sub>	V <sub>D</sub> = 15V	1	2	3	ms	

d. Thermal resistance ( $T_j = 25^\circ\text{C}$ )

CHARACTERISTIC	SYMBOL	TEST CONDITION	MIN.	TYP.	MAX.	UNIT
Junction to Case Thermal Resistance	$R_{th(j-c)}$	Inverter IGBT stage	—	—	0.553	$^\circ\text{C/W}$
		Inverter FRD stage	—	—	1.000	
		Brake IGBT stage	—	—	1.562	
		Brake FRD stage	—	—	2.000	
Case to Fin Thermal Resistance	$R_{th(c-f)}$	Compound is applied	—	0.05	—	$^\circ\text{C/W}$

Note 1 : Switching time test circuit & timing chart

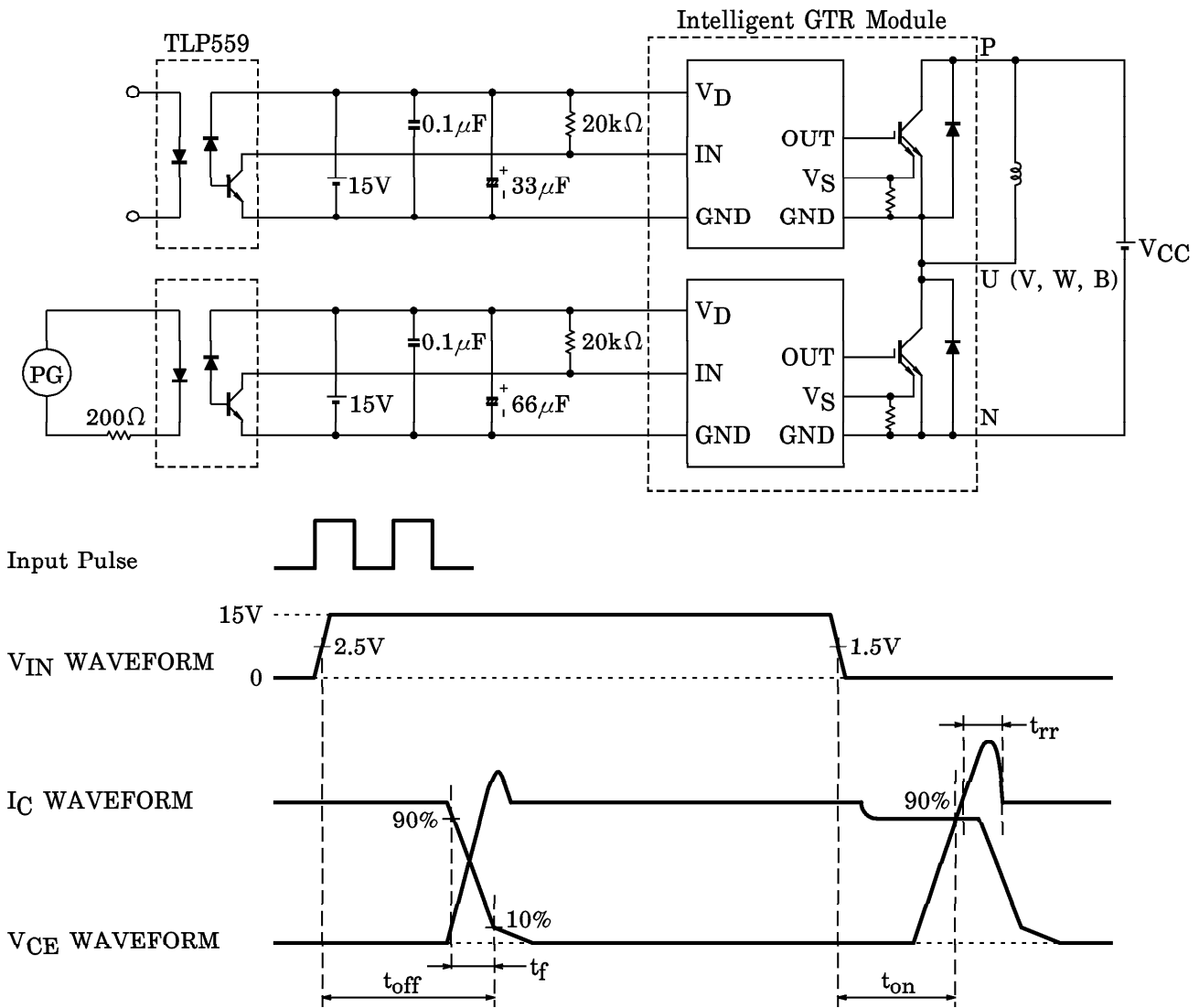

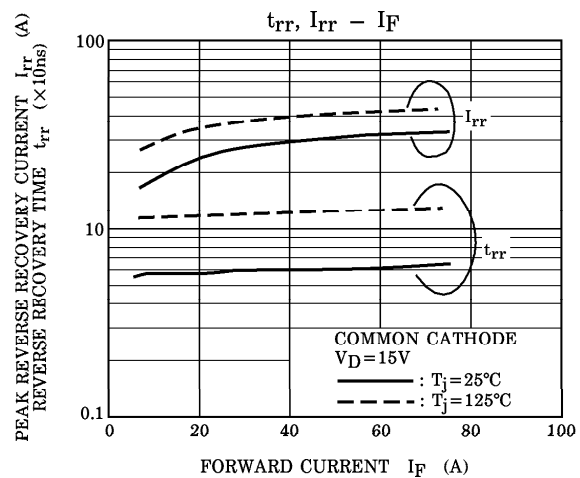
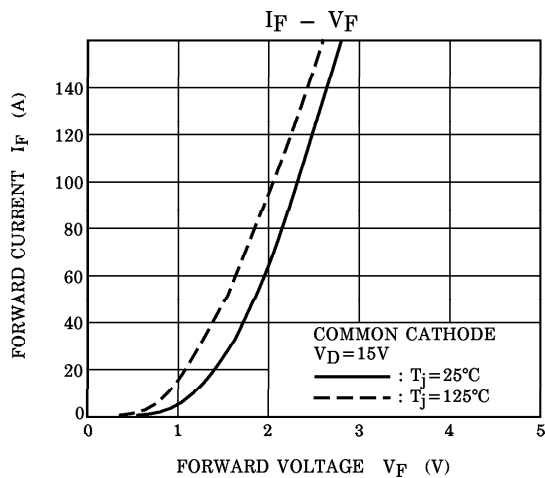
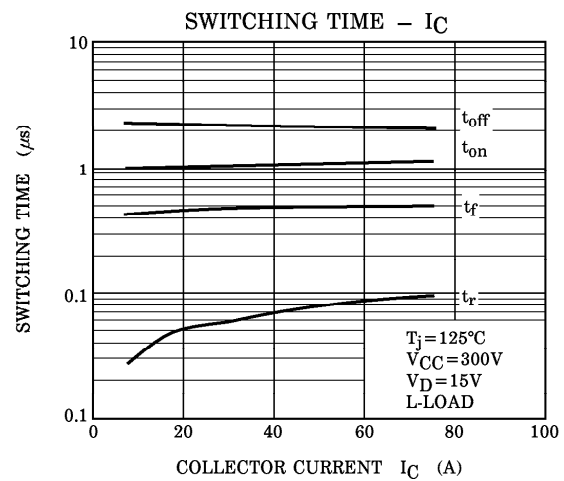
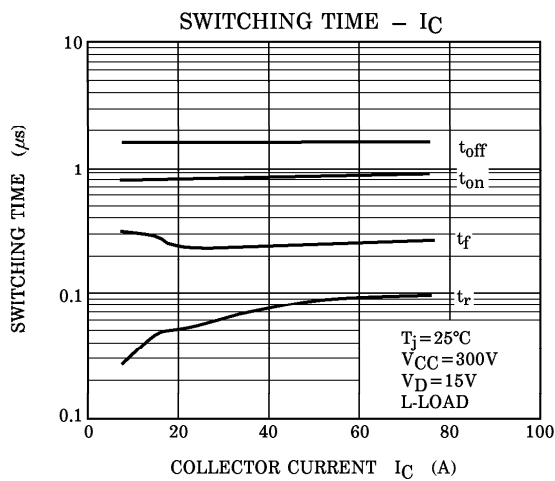
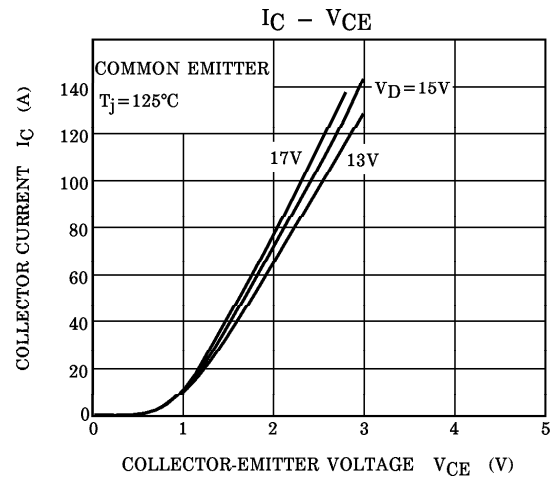
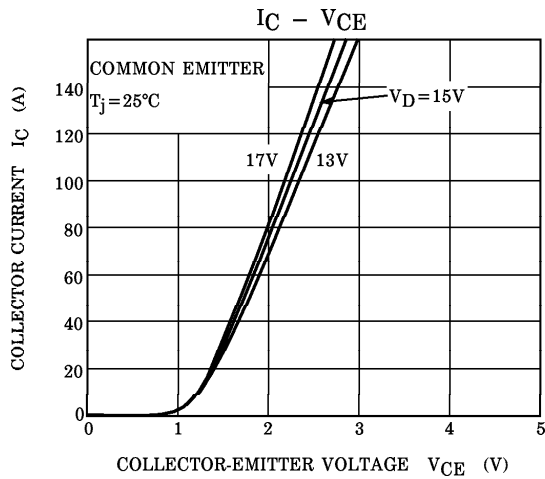

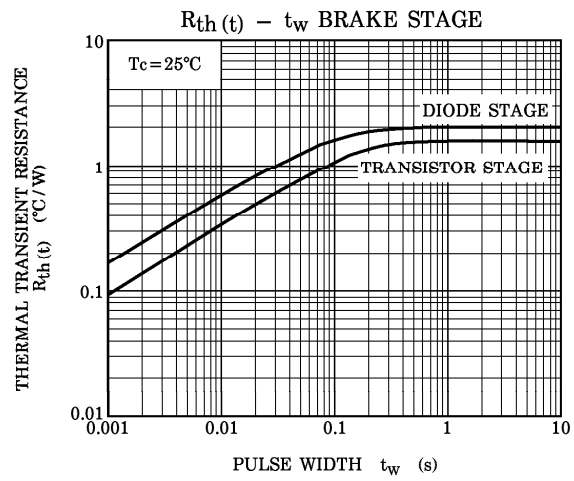
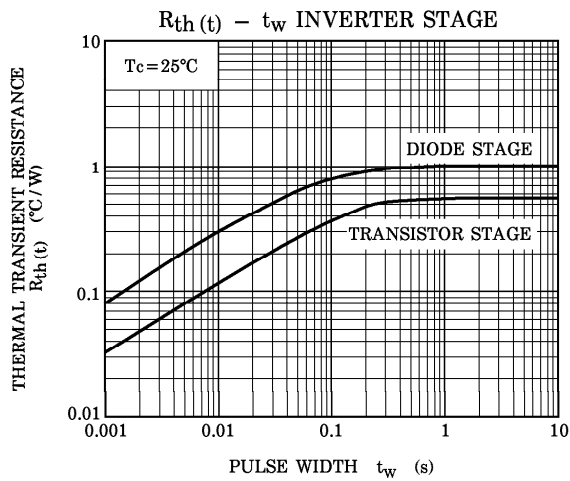
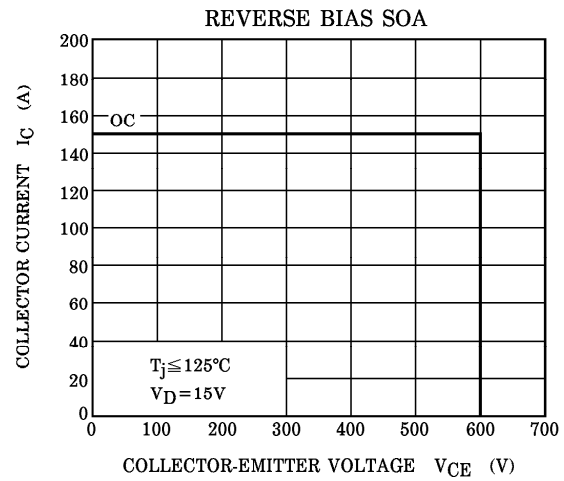
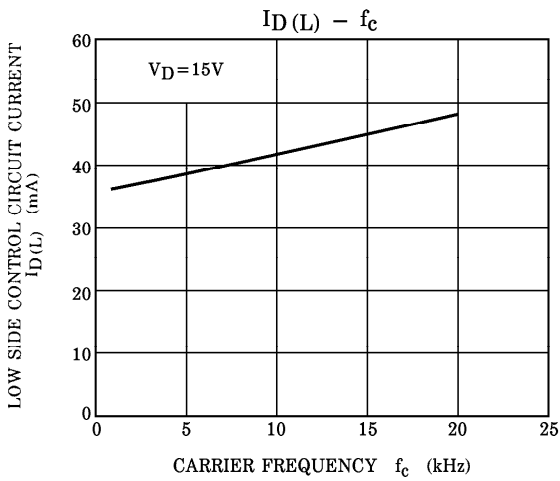
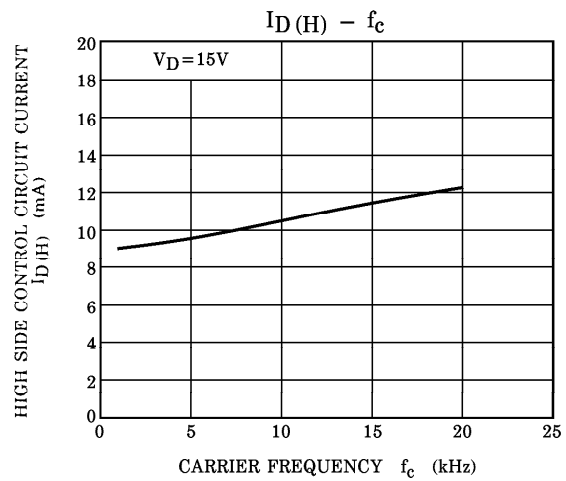
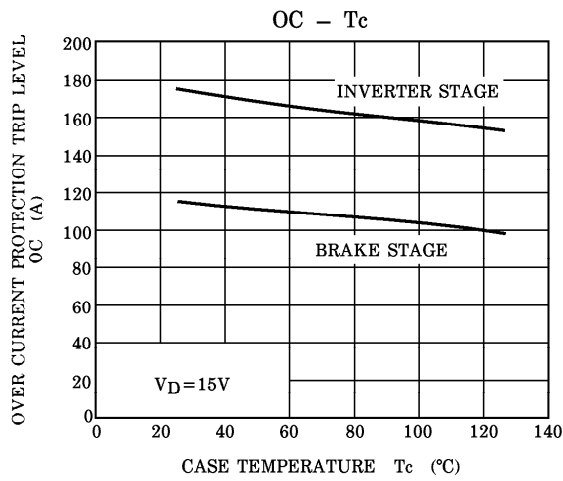

OUTLINE

Unit : mm

