

MIG50Q6CSB1X (1200V/50A 6in1)

High Power Switching Applications
 Motor Control Applications

- Integrates inverter and control circuits (IGBT drive units, protection units for short-circuit current, over current, under voltage and over temperature) in one package.
- The electrodes are isolated from case.
- $V_{CE(sat)} = 2.2\text{ V (typ.)}$
- UL recognized: File No. E87989

Equivalent Circuit

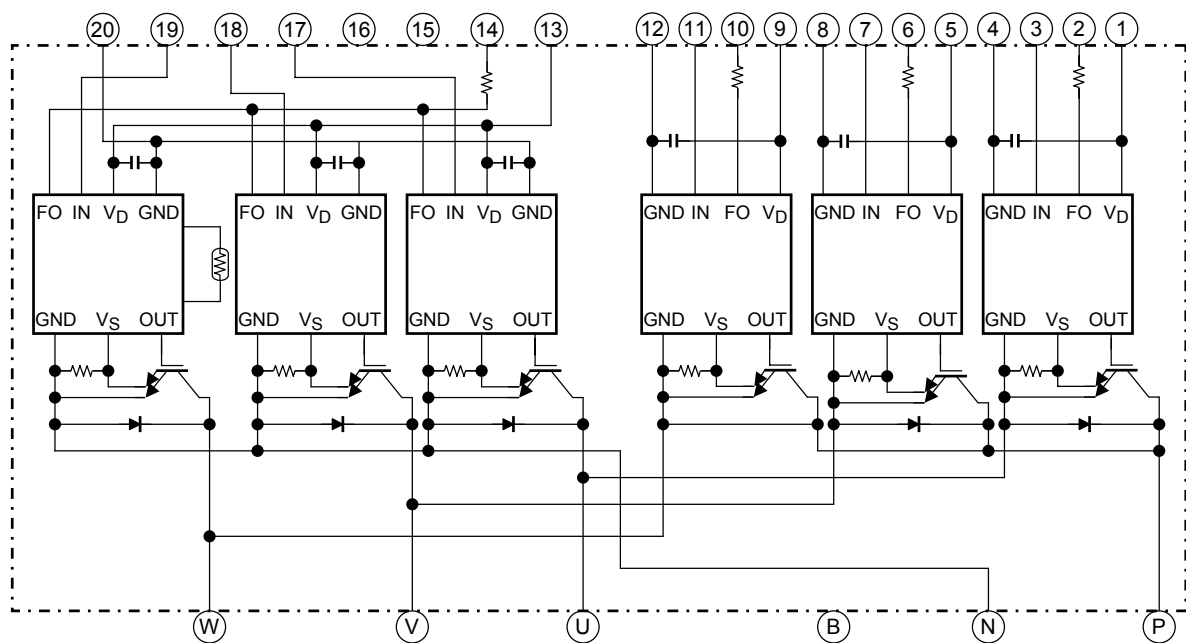

| | | | | | | |
|-------------|-------------|------------|------------|-------------|--------------|------------|
| 1. $V_D(U)$ | 2. FO (U) | 3. IN (U) | 4. GND (U) | 5. $V_D(V)$ | 6. FO (V) | 7. IN (V) |
| 8. GND (V) | 9. $V_D(W)$ | 10. FO (W) | 11. IN (W) | 12. GND (W) | 13. $V_D(L)$ | 14. FO (L) |
| 15. Open | 16. Open | 17. IN (X) | 18. IN (Y) | 19. IN (Z) | 20. GND (L) | |

Package Dimensions: TOSHIBA 2-108G1D

Unit: mm

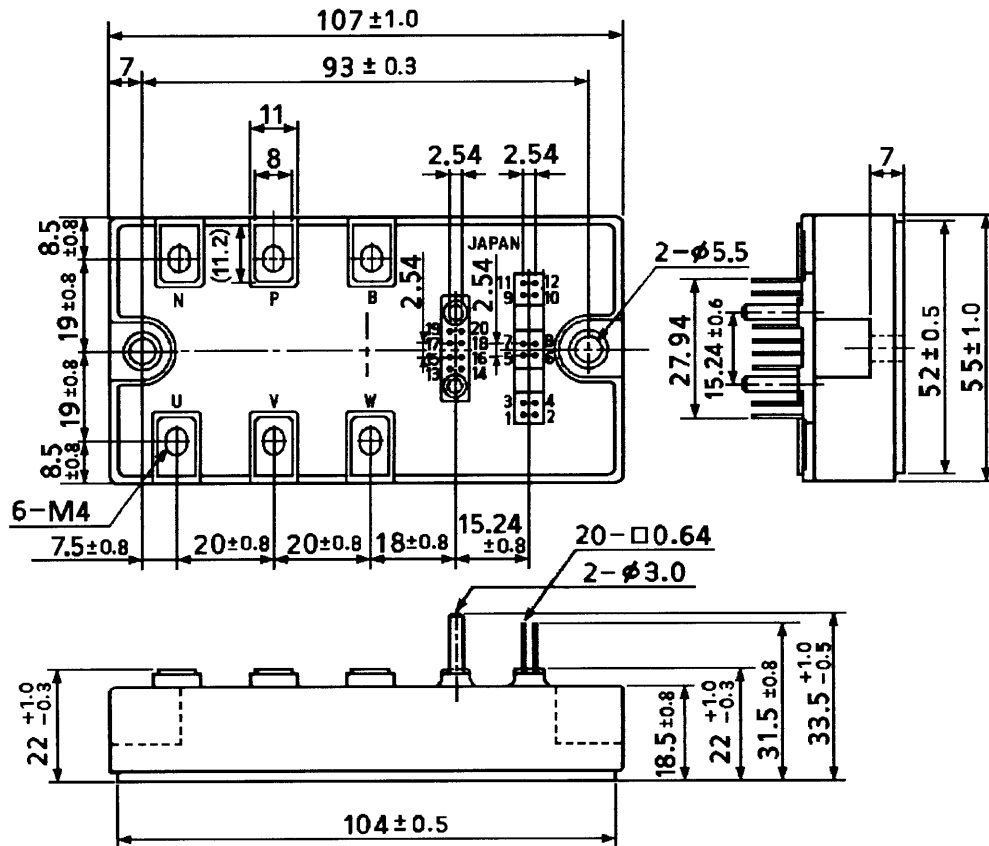

- | | | | | | |
|---------------|-------------|--------------|------------|--------------|-------------|
| 1. V_D (U) | 2. FO (U) | 3. IN (U) | 4. GND (U) | 5. V_D (V) | 6. FO (V) |
| 7. IN (V) | 8. GND (V) | 9. V_D (W) | 10. FO (W) | 11. IN (W) | 12. GND (W) |
| 13. V_D (L) | 14. FO (L) | 15. Open | 16. Open | 17. IN (X) | 18. IN (Y) |
| 19. IN (Z) | 20. GND (L) | | | | |

Signal Terminal Layout

Unit: mm

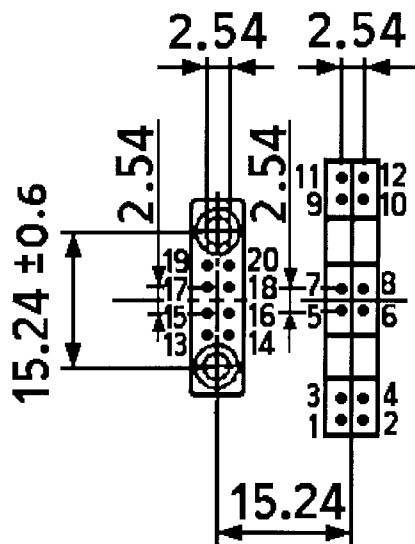

| | | | | | | | | | | | |
|-----|--------------------|-----|---------|-----|--------------------|-----|---------|-----|--------------------|-----|---------|
| 1. | V _D (U) | 2. | FO (U) | 3. | IN (U) | 4. | GND (U) | 5. | V _D (V) | 6. | FO (V) |
| 7. | IN (V) | 8. | GND (V) | 9. | V _D (W) | 10. | FO (W) | 11. | IN (W) | 12. | GND (W) |
| 13. | V _D (L) | 14. | FO (L) | 15. | Open | 16. | Open | 17. | IN (X) | 18. | IN (Y) |
| 19. | IN (Z) | 20. | GND (L) | | | | | | | | |

Maximum Ratings (unless otherwise specified, $T_j = 25^\circ\text{C}$)

| Stage | Characteristic | Condition | Symbol | Ratings | Unit |
|----------|-----------------------------|-------------------------------|-----------|------------|------------------|
| Inverter | Supply voltage | P-N power terminal | V_{CC} | 900 | V |
| | Collector-emitter voltage | — | V_{CES} | 1200 | V |
| | Collector current | $T_c = 25^\circ\text{C}$, DC | I_C | 50 | A |
| | Forward current | $T_c = 25^\circ\text{C}$, DC | I_F | 50 | A |
| | Collector power dissipation | $T_c = 25^\circ\text{C}$ | P_C | 580 | W |
| | Junction temperature | — | T_j | 150 | $^\circ\text{C}$ |
| Control | Control supply voltage | V_D -GND terminal | V_D | 20 | V |
| | Input voltage | IN-GND terminal | V_{IN} | 20 | V |
| | Fault output voltage | FO-GND terminal | V_{FO} | 20 | V |
| | Fault output current | FO sink current | I_{FO} | 14 | mA |
| Module | Operating temperature | — | T_c | -20 to 100 | $^\circ\text{C}$ |
| | Storage temperature range | — | T_{stg} | -40 to 125 | $^\circ\text{C}$ |
| | Isolation voltage | AC 1 minute | V_{ISO} | 2500 | V |
| | Screw torque (terminal) | M4 | — | 2 | N·m |
| | Screw torque (mounting) | M5 | — | 3 | N·m |

Electrical Characteristics

1. Inverter Stage

| Characteristic | Symbol | Test Condition | Min | Typ. | Max | Unit | |
|--------------------------------------|---------------|---|---------------------------|------|-----|---------------|----|
| Collector cut-off current | I_{CEX} | $V_{CE} = 1200\text{ V}$ | $T_j = 25^\circ\text{C}$ | — | — | 1 | mA |
| | | | $T_j = 125^\circ\text{C}$ | — | — | 10 | |
| Collector-emitter saturation voltage | $V_{CE(sat)}$ | $V_D = 15\text{ V}$, $I_C = 50\text{ A}$, $V_{IN} = 15\text{ V} \leftrightarrow 0\text{ V}$ | $T_j = 25^\circ\text{C}$ | — | 2.2 | 2.6 | V |
| | | | $T_j = 125^\circ\text{C}$ | — | — | 3.0 | |
| Forward voltage | V_F | $I_F = 50\text{ A}$, $T_j = 25^\circ\text{C}$ | — | 2.4 | 2.8 | V | |
| Switching time | t_{on} | $V_{CC} = 600\text{ V}$, $I_C = 50\text{ A}$, $V_D = 15\text{ V}$, $V_{IN} = 15\text{ V} \leftrightarrow 0\text{ V}$, $T_j = 25^\circ\text{C}$, Inductive load (Note 1) | — | 2.0 | 3.0 | μs | |
| | $t_c(on)$ | | — | 0.3 | — | | |
| | t_{rr} | | — | 0.3 | — | | |
| | t_{off} | | — | 1.5 | 2.5 | | |
| | $t_c(off)$ | | — | 0.4 | — | | |

Note 1: Switching time test circuit and timing chart.

2. Control Stage ($T_j = 25^\circ\text{C}$)

| Characteristic | | Symbol | Test Condition | Min | Typ. | Max | Unit |
|---|-------------|----------------|---|------|------|------|------------------|
| Control circuit current | High side | I_D (H) | $V_D = 15\text{ V}$ | — | 13 | 17 | mA |
| | Low side | I_D (L) | | — | 39 | 51 | |
| Input-on signal voltage | | V_{IN} (on) | $V_D = 15\text{ V}$ | 1.4 | 1.6 | 1.8 | V |
| Input-off signal voltage | | V_{IN} (off) | $V_D = 15\text{ V}$ | 2.2 | 2.5 | 2.8 | V |
| Fault output current | Protection | I_{FO} (on) | $V_D = 15\text{ V}$ | 8 | 10 | 12 | mA |
| | Normal | I_{FO} (off) | | — | — | 0.1 | |
| Over current protection trip level | Inverter | OC | $V_D = 15\text{ V}, T_j \leq 125^\circ\text{C}$ | 80 | — | — | A |
| Short-circuit current protection trip level | Inverter | SC | $V_D = 15\text{ V}, T_j \leq 125^\circ\text{C}$ | 80 | — | — | A |
| Over current cut-off time | | t_{off} (OC) | $V_D = 15\text{ V}$ | — | 5 | — | μs |
| Over temperature protection | Trip level | OT | Case temperature | 110 | 118 | 125 | $^\circ\text{C}$ |
| | Reset level | OTr | | — | 98 | — | |
| Control supply under voltage protection | Trip level | UV | — | 11.0 | 12.0 | 12.5 | V |
| | Reset level | UVr | | 12.0 | 12.5 | 13.0 | |
| Fault output pulse width | | t_{FO} | $V_D = 15\text{ V}$ | 1 | 2 | 3 | ms |

3. Thermal Resistance ($T_c = 25^\circ\text{C}$)

| Characteristic | Symbol | Test Condition | Min | Typ. | Max | Unit |
|-------------------------------------|----------------|---------------------|-----|-------|-------|--------------------|
| Junction to case thermal resistance | R_{th} (j-c) | Inverter IGBT stage | — | — | 0.215 | $^\circ\text{C/W}$ |
| | | Inverter FRD stage | — | — | 0.464 | |
| Case to fin thermal resistance | R_{th} (c-f) | Compound is applied | — | 0.017 | — | $^\circ\text{C/W}$ |

Switching Time Test Circuit

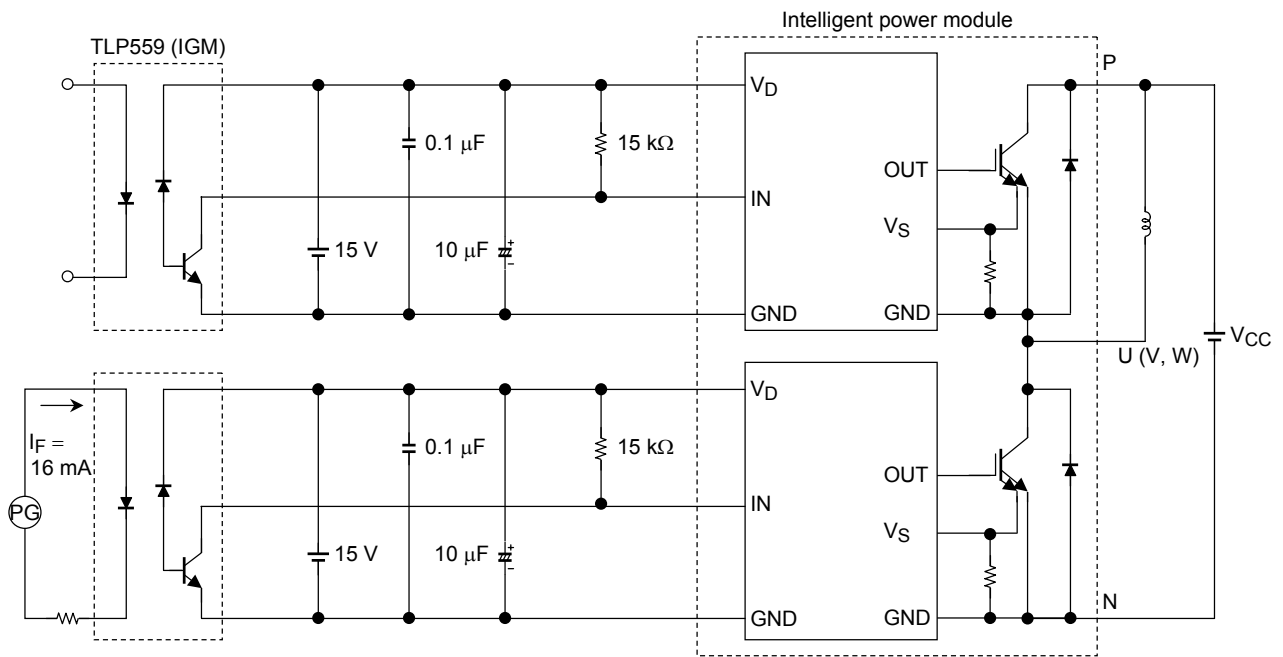

Timing Chart

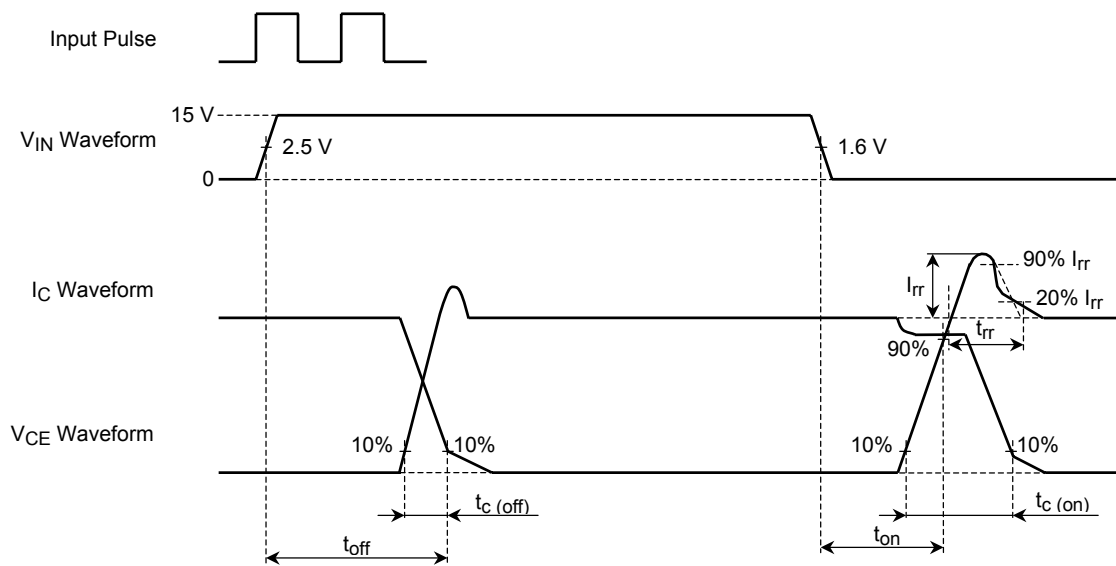

4. Recommended conditions for application

| Characteristic | Symbol | Test Condition | Min | Typ. | Max | Unit |
|------------------------|-------------------|--|------|------|------|------|
| Supply voltage | V _{CC} | P-N Power terminal | — | 600 | 800 | V |
| Control supply voltage | V _D | V _D -GND Signal terminal | 13.5 | 15 | 16.5 | V |
| Carrier frequency | f _c | PWM Control | — | — | 20 | kHz |
| Dead time | t _{dead} | Switching time test circuit (see page.6) (Note 2) | 3 | — | — | μs |

Note 2: The table lists Dead time requirements for the module input, excluding photocoupler delays. When specifying dead time requirements for the photocoupler input, please add photocoupler delays to the dead time given above.

Dead Time Timing Chart

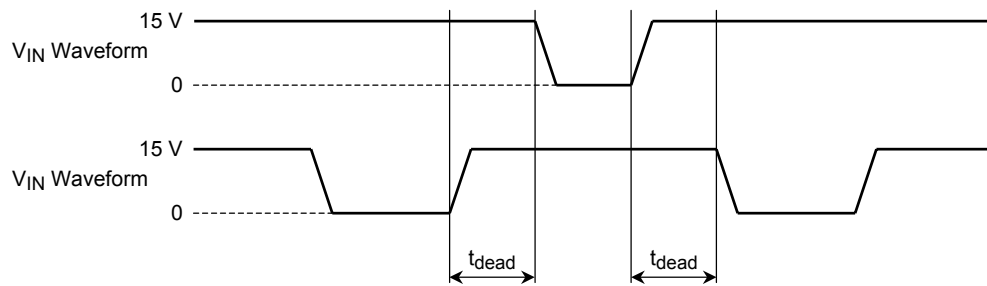

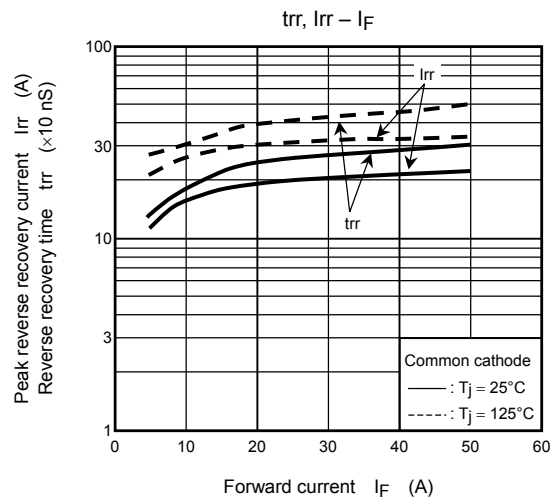
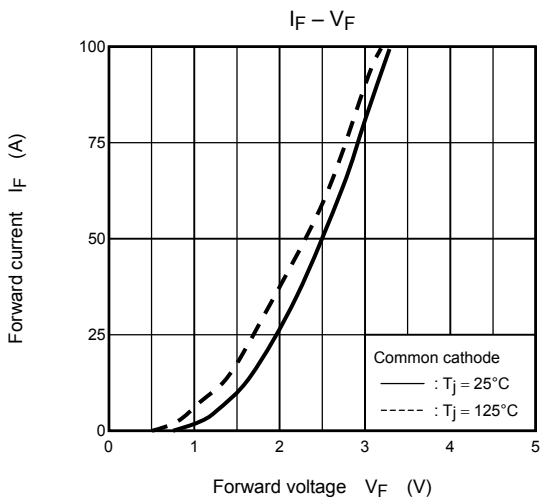
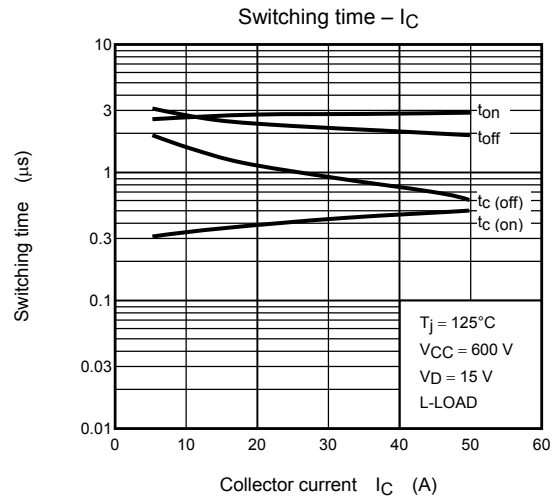
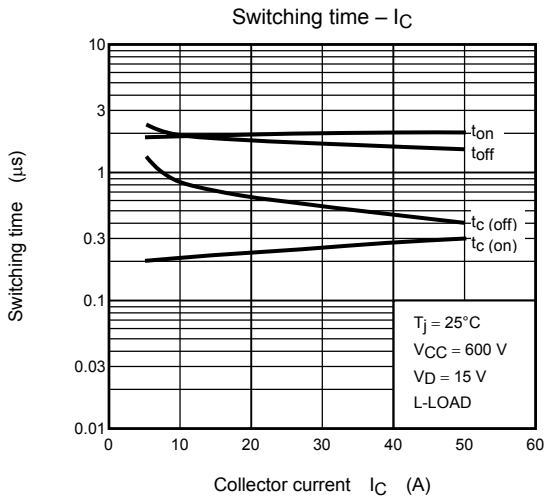
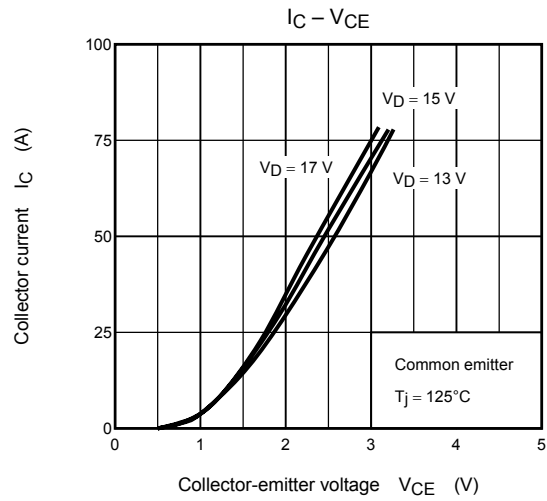
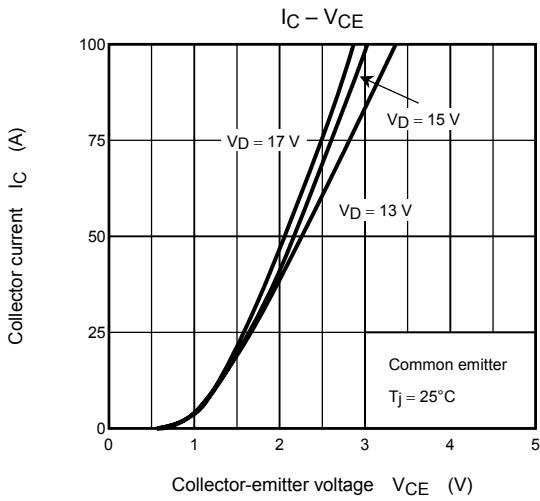

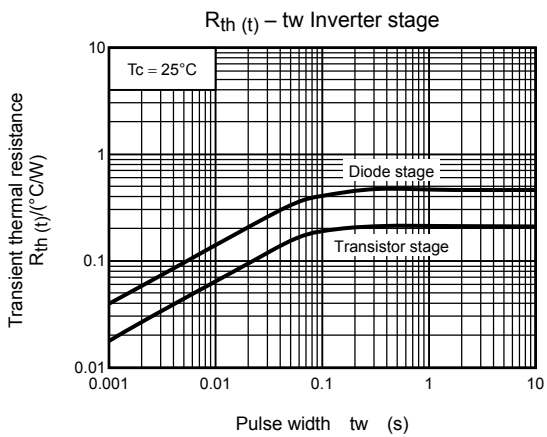
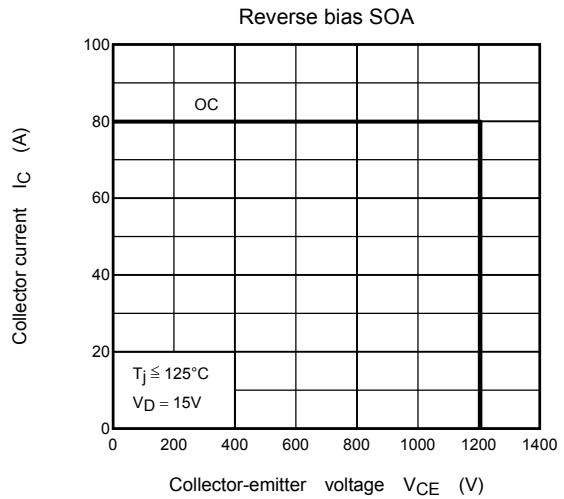
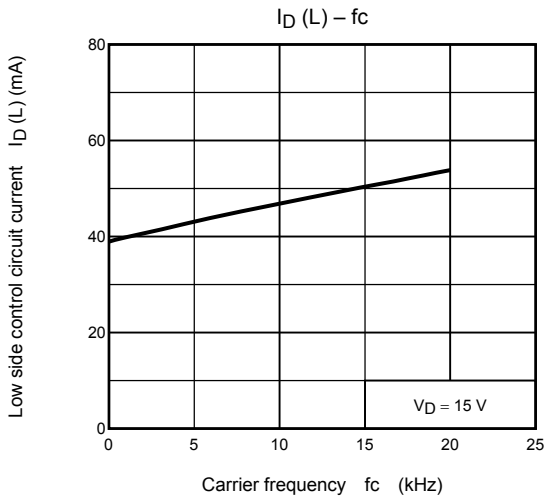
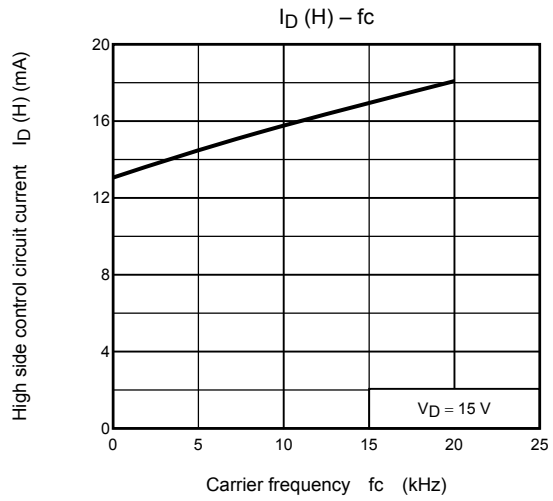
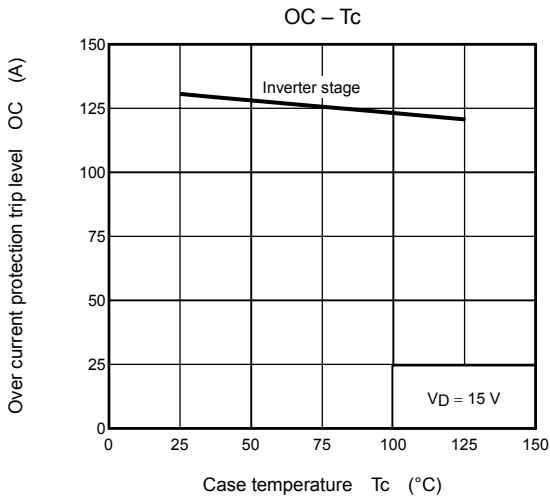

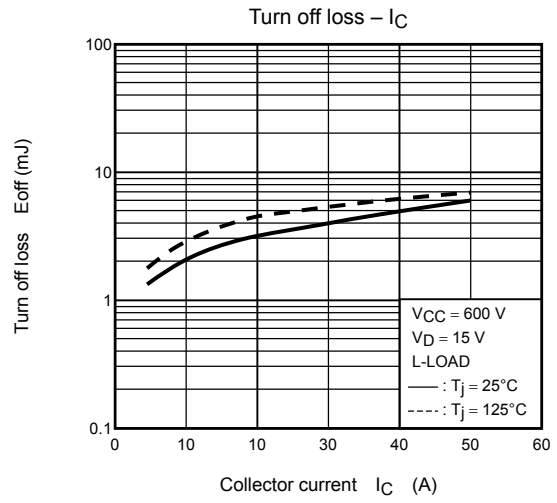
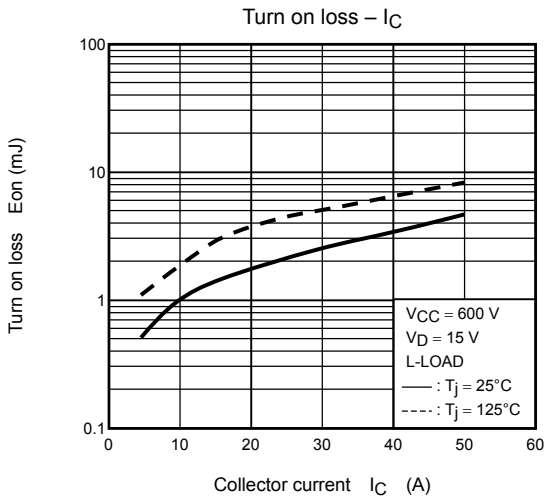

RESTRICTIONS ON PRODUCT USE

030619EAA

- The information contained herein is subject to change without notice.
- The information contained herein is presented only as a guide for the applications of our products. No responsibility is assumed by TOSHIBA for any infringements of patents or other rights of the third parties which may result from its use. No license is granted by implication or otherwise under any patent or patent rights of TOSHIBA or others.
- TOSHIBA is continually working to improve the quality and reliability of its products. Nevertheless, semiconductor devices in general can malfunction or fail due to their inherent electrical sensitivity and vulnerability to physical stress. It is the responsibility of the buyer, when utilizing TOSHIBA products, to comply with the standards of safety in making a safe design for the entire system, and to avoid situations in which a malfunction or failure of such TOSHIBA products could cause loss of human life, bodily injury or damage to property.
In developing your designs, please ensure that TOSHIBA products are used within specified operating ranges as set forth in the most recent TOSHIBA products specifications. Also, please keep in mind the precautions and conditions set forth in the "Handling Guide for Semiconductor Devices," or "TOSHIBA Semiconductor Reliability Handbook" etc..
- The TOSHIBA products listed in this document are intended for usage in general electronics applications (computer, personal equipment, office equipment, measuring equipment, industrial robotics, domestic appliances, etc.). These TOSHIBA products are neither intended nor warranted for usage in equipment that requires extraordinarily high quality and/or reliability or a malfunction or failure of which may cause loss of human life or bodily injury ("Unintended Usage"). Unintended Usage include atomic energy control instruments, airplane or spaceship instruments, transportation instruments, traffic signal instruments, combustion control instruments, medical instruments, all types of safety devices, etc.. Unintended Usage of TOSHIBA products listed in this document shall be made at the customer's own risk.
- TOSHIBA products should not be embedded to the downstream products which are prohibited to be produced and sold, under any law and regulations.