

# MIG50J201H

High Power Switching Applications  
 Motor Control Applications

- Integrates inverter, brake power circuits & control circuits (IGBT drive units, protection units for over-current, under-voltage & over-temperature) in one package.
- The electrodes are isolated from case.
- High speed type IGBT :  $V_{CE(sat)} = 2.5\text{ V (Max.)}$   
 $t_{off} = 3.0\ \mu\text{s (Max.)}$   
 $t_{rr} = 0.30\ \mu\text{s (Max.)}$
- Package Dimensions : TOSHIBA 2-110A1A
- Weight : 520 g

## Equivalent Circuit

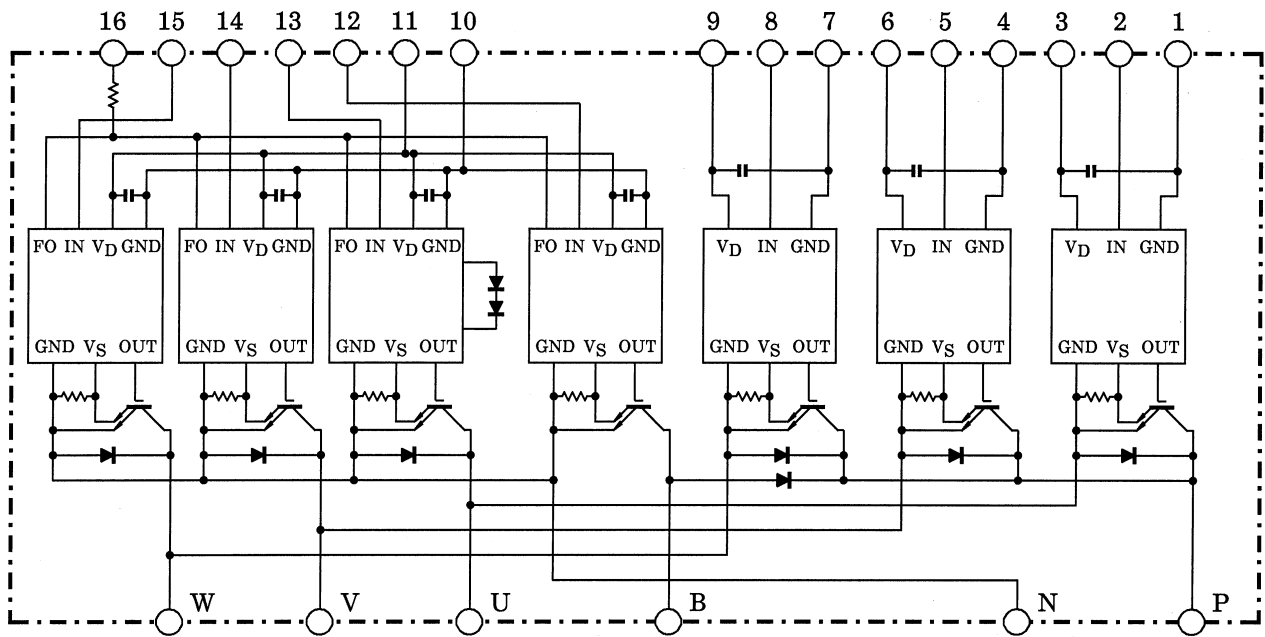

- |            |            |                       |             |                        |                       |
|------------|------------|-----------------------|-------------|------------------------|-----------------------|
| 1. GND (U) | 2. IN (U)  | 3. V <sub>D</sub> (U) | 4. GND (V)  | 5. IN (V)              | 6. V <sub>D</sub> (V) |
| 7. GND (W) | 8. IN (W)  | 9. V <sub>D</sub> (W) | 10. GND (L) | 11. V <sub>D</sub> (L) | 12. IN (B)            |
| 13. IN (X) | 14. IN (Y) | 15. IN (Z)            | 16. FO      |                        |                       |

## Maximum Ratings ( $T_j = 25^\circ\text{C}$ )

Stage	Characteristic	Condition	Symbol	Rated	Unit
Inverter	Supply voltage	P-N power terminal	$V_{CC}$	450	V
	Collector-emitter voltage	—	$V_{CES}$	600	V
	Collector current	$T_c = 25^\circ\text{C}$ , DC	$I_C$	50	A
	Forward current	$T_c = 25^\circ\text{C}$ , DC	$I_F$	50	A
	Collector power dissipation	$T_c = 25^\circ\text{C}$	$P_C$	150	W
	Junction temperature	—	$T_j$	150	$^\circ\text{C}$
Brake	Supply voltage	P-N power terminal	$V_{CC}$	450	V
	Collector-emitter voltage	—	$V_{CES}$	600	V
	Collector current	$T_c = 25^\circ\text{C}$ , DC	$I_C$	30	A
	Reverse voltage	—	$V_R$	600	V
	Forward current	$T_c = 25^\circ\text{C}$ , DC	$I_F$	30	A
	Collector power dissipation	$T_c = 25^\circ\text{C}$	$P_C$	80	W
	Junction temperature	—	$T_j$	150	$^\circ\text{C}$
Control	Control supply voltage	$V_D$ -GND terminal	$V_D$	20	V
	Input voltage	IN-GND terminal	$V_{IN}$	20	V
	Fault output voltage	FO-GND (L) terminal	$V_{FO}$	20	V
	Fault output current	FO sink current	$I_{FO}$	14	mA
Module	Operating temperature	—	TC	-20 ~ +100	$^\circ\text{C}$
	Storage temperature range	—	$T_{stg}$	-40 ~ +125	$^\circ\text{C}$
	Isolation voltage	AC 1 minute	$V_{ISO}$	2500	V
	Screw torque	M5	—	3	Nm

## Electrical Characteristics ( $T_j = 25^\circ\text{C}$ )

### a. Inverter Stage

Characteristic	Symbol	Test Condition	Min	Typ.	Max	Unit	
Collector cut-off current	$I_{CEX}$	$V_{CE} = 600\text{V}$	$T_j = 25^\circ\text{C}$	—	—	1	mA
			$T_j = 125^\circ\text{C}$	—	—	20	
Collector-emitter saturation voltage	$V_{CE(sat)}$	$V_D = 15\text{V}$ , $I_C = 50\text{A}$ $V_{IN} = 15\text{V} \rightarrow 0\text{V}$	$T_j = 25^\circ\text{C}$	—	2.0	2.5	V
			$T_j = 125^\circ\text{C}$	—	2.0	—	
Forward voltage	$V_F$	$I_F = 50\text{A}$	—	2.1	3.0	V	
Switching time	$t_{on}$	$V_{CC} = 300\text{V}$ , $I_C = 50\text{A}$ $V_D = 15\text{V}$ , $V_{IN} = 15\text{V} \leftrightarrow 0\text{V}$ Inductive load (Note 1)	—	0.8	2.0	$\mu\text{s}$	
	$t_{off}$		—	1.2	3.0		
	$t_f$		—	0.25	0.5		
	$t_{rr}$		—	0.1	0.3		

**b. Brake Stage**

Characteristic		Symbol	Test Condition	Min	Typ.	Max	Unit	
Collector cut-off current		$I_{CEX}$	$V_{CE} = 600V$	$T_j = 25^\circ C$	—	—	1	mA
				$T_j = 125^\circ C$	—	—	20	
Collector-emitter saturation voltage		$V_{CE (sat)}$	$V_D = 15 V, I_C = 30 A$ $V_{IN} = 15 V \rightarrow 0 V$	$T_j = 25^\circ C$	—	1.7	2.7	V
				$T_j = 125^\circ C$	—	1.6	—	
Reverse current		$I_R$	$V_R = 600 V$	$T_j = 25^\circ C$	—	—	1	mA
				$T_j = 125^\circ C$	—	—	20	
Forward voltage		$V_F$	$I_F = 30A$	—	2.0	2.5	V	
Switching time	$t_{on}$		$V_{CC} = 300 V, I_C = 30 A$ $V_D = 15 V, V_{IN} = 15 V \leftrightarrow 0 V$ Inductive load (Note 1)	—	0.9	2.0	$\mu s$	
	$t_{off}$			—	1.7	3.0		
	$t_f$			—	0.25	0.5		
	$t_{rr}$			—	0.15	0.3		

**c. Control Stage ( $T_j = 25^\circ C$ )**

Characteristic		Symbol	Test Condition	Min	Typ.	Max	Unit
Control circuit current	High side	$I_D (H)$	$V_D = 15 V$	—	8	—	mA
	Low side	$I_D (L)$		—	32	—	
Input-on signal voltage		$V_{IN (on)}$	$V_D = 15 V, I_C = 50 mA$	1.3	1.5	1.7	V
Input-off signal voltage		$V_{IN (off)}$	$V_D = 15 V, I_C = 50 mA$	2.2	2.5	2.8	V
Fault output current	Protection	$I_{FO (on)}$	$V_D = 15 V$	8	10	12	mA
	Normal	$I_{FO (off)}$		—	—	1	
Over current protection trip level	Inverter	OC	$V_D = 15 V, T_j = 125^\circ C$	75	100	—	A
	Brake			40	—	—	
Short circuit protection trip level	Inverter	SC	$V_D = 15 V, T_j = 125^\circ C$	110	150	—	A
	Brake			60	—	—	
Over current cut-off time		$t_{off (OC)}$	$V_D = 15 V$	—	5	—	$\mu s$
Over temperature protection	Trip level	OT	Case temperature	110	118	125	$^\circ C$
	Reset level	OTr		—	98	—	
Control supply under voltage protection	Trip level	UV	—	11.0	12.0	12.5	V
	Reset level	UVr		—	12.5	—	
Fault output pulse width		$t_{FO}$	$V_D = 15 V$	1	2	3	ms

**d. Thermal Resistance ( $T_j = 25^\circ\text{C}$ )**

Characteristic	Symbol	Test Condition	Min	Typ.	Max	Unit
Junction to case thermal resistance	$R_{th(j-c)}$	Inverter IGBT stage	—	—	0.833	$^\circ\text{C/W}$
		Inverter FRD stage	—	—	2.000	
		Brake IGBT stage	—	—	1.562	
		Brake FRD stage	—	—	2.000	
Case to fin thermal resistance	$R_{th(c-f)}$	Compound is applied	—	0.05	—	$^\circ\text{C/W}$

Note 1: Switching time test circuit & timing chart

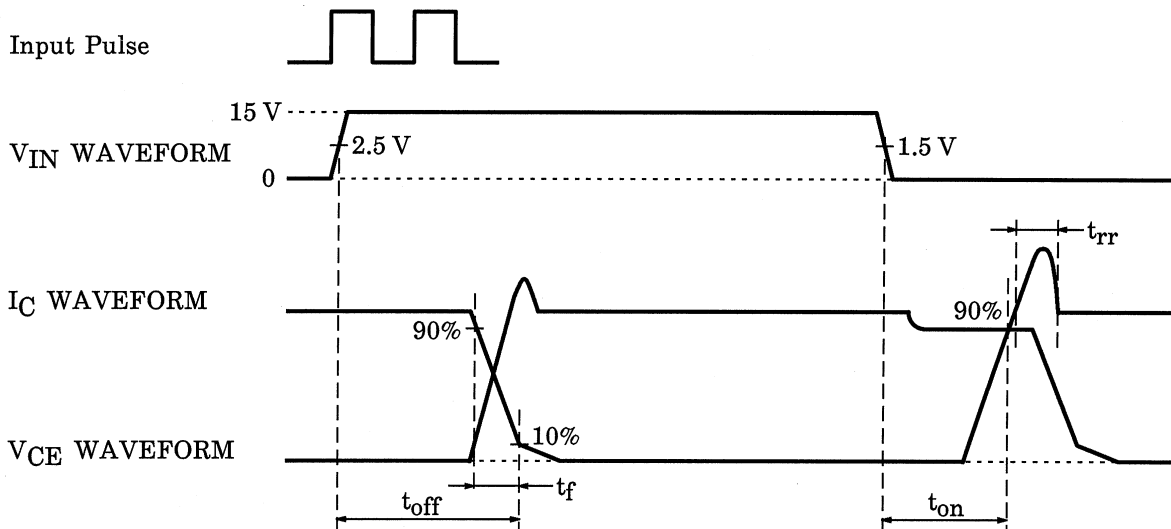
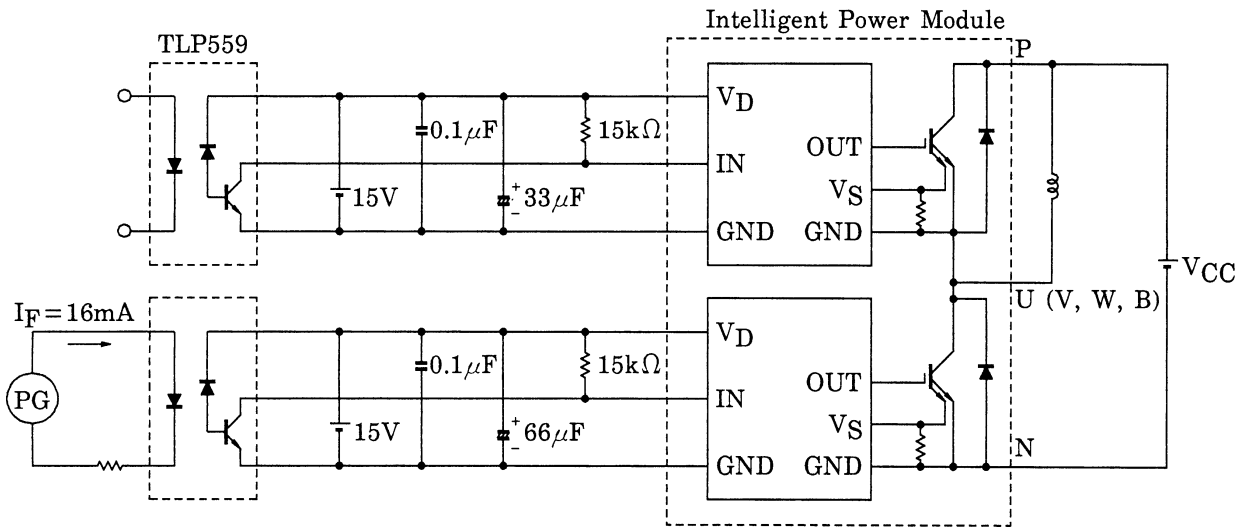

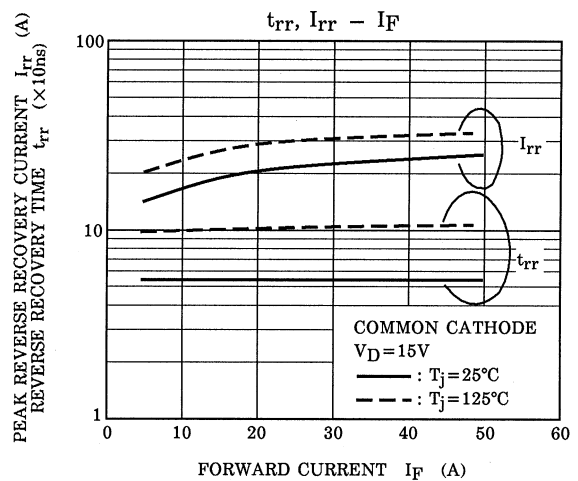
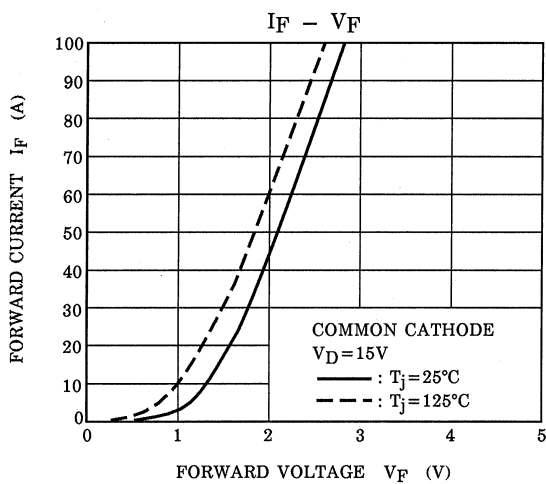
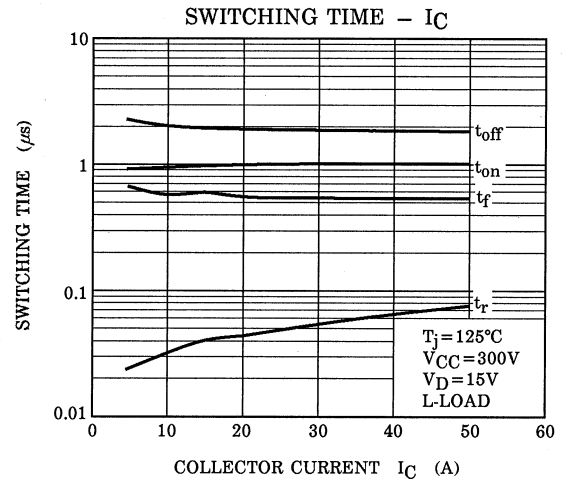
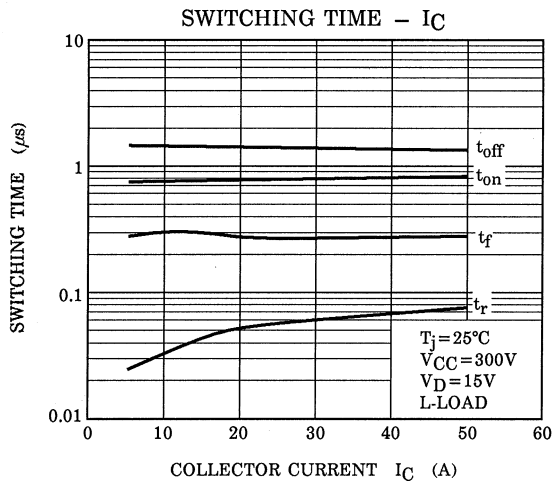
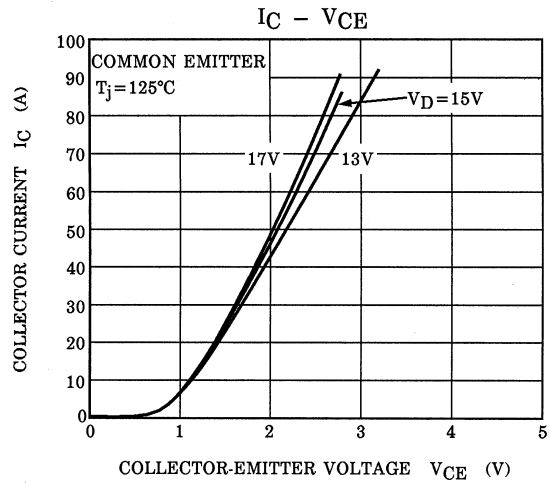
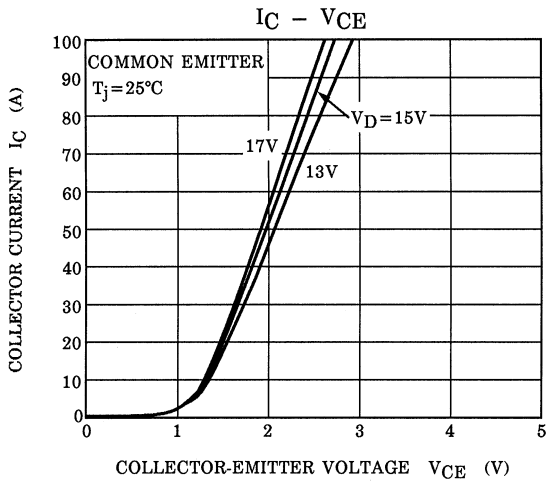

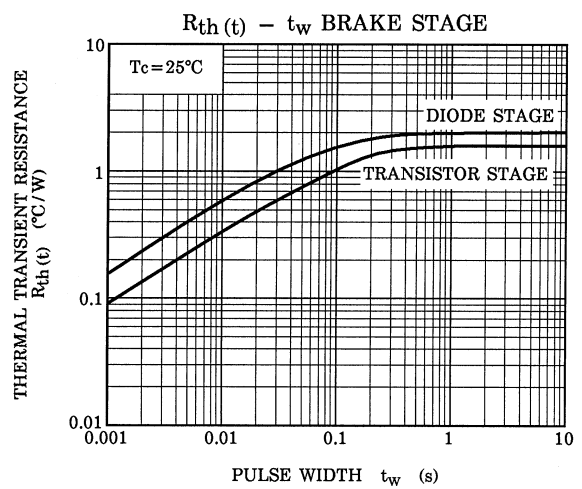
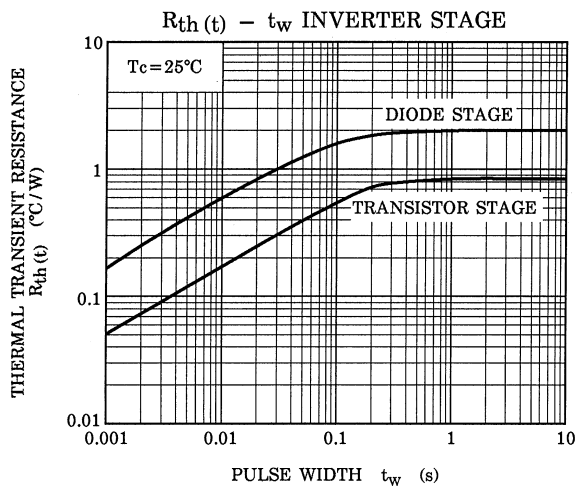
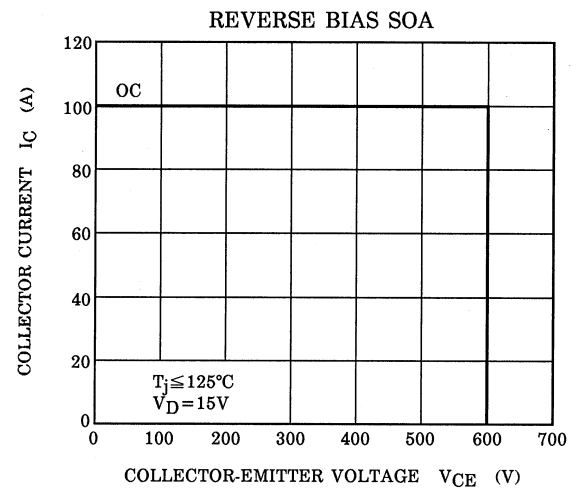
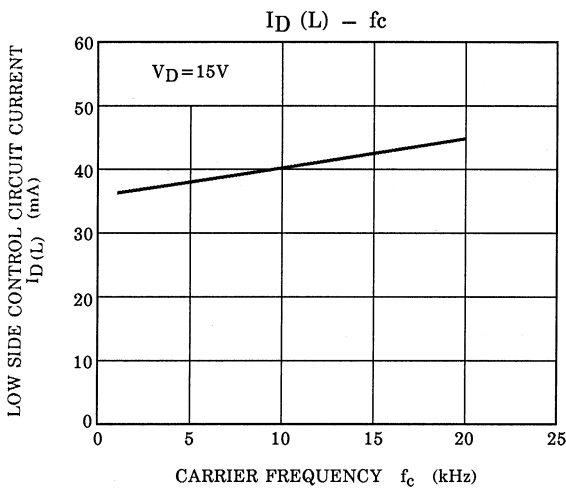
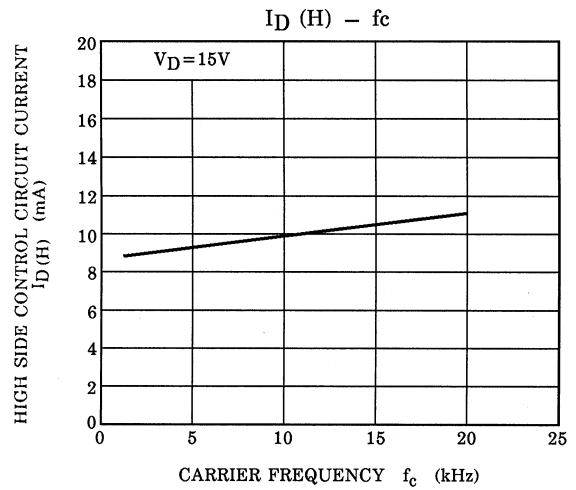
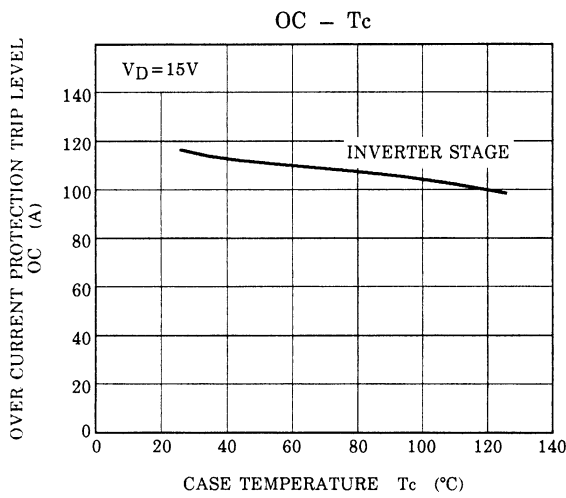

## Package Dimensions: TOSHIBA 2-110A1A

Unit: mm

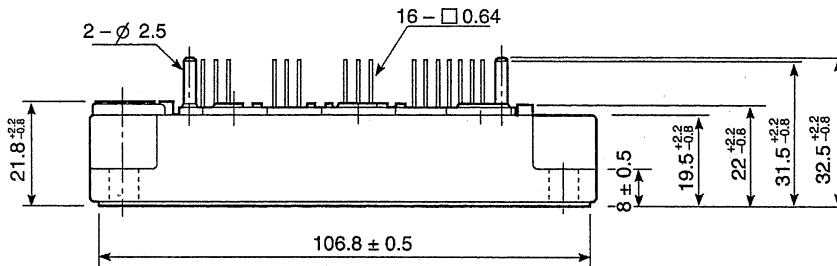
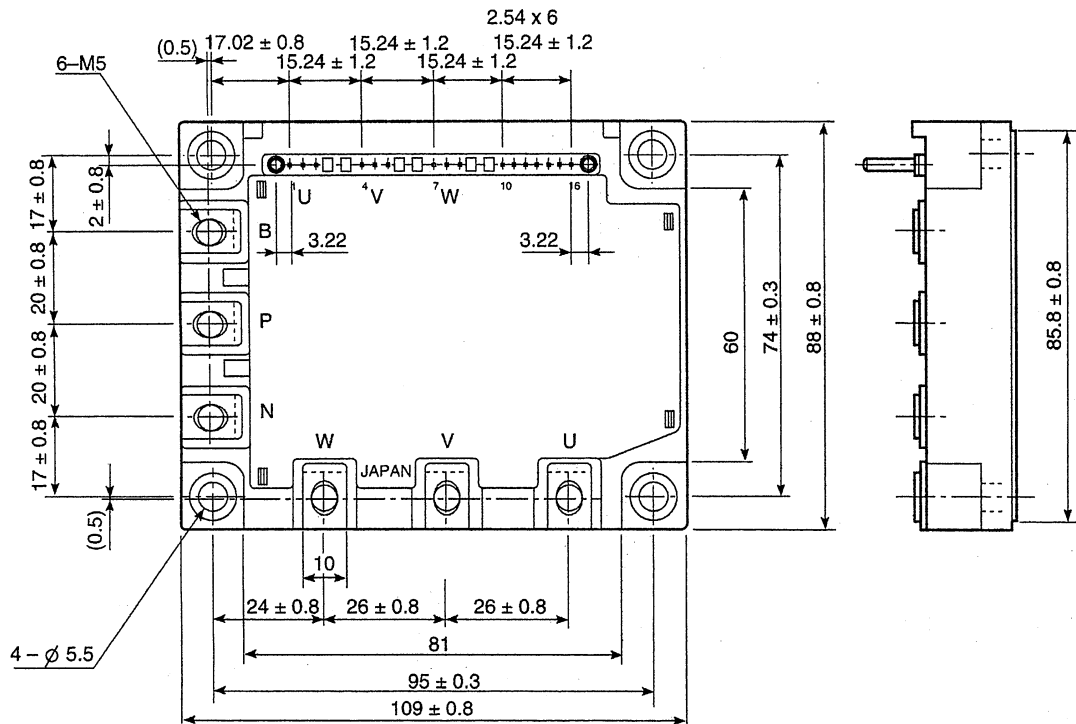

	GND	IN	VD	GND	IN	VD	GND	VD	IN	IN	IN	IN	IN	FO		
	(U)	(V)	(W)	(X)	(Y)	(Z)										
Signal Terminal	1	2	3	4	5	6	7	8	9	10	11	12	13	14	15	16

**RESTRICTIONS ON PRODUCT USE**

000707EAA

- TOSHIBA is continually working to improve the quality and reliability of its products. Nevertheless, semiconductor devices in general can malfunction or fail due to their inherent electrical sensitivity and vulnerability to physical stress. It is the responsibility of the buyer, when utilizing TOSHIBA products, to comply with the standards of safety in making a safe design for the entire system, and to avoid situations in which a malfunction or failure of such TOSHIBA products could cause loss of human life, bodily injury or damage to property.  
In developing your designs, please ensure that TOSHIBA products are used within specified operating ranges as set forth in the most recent TOSHIBA products specifications. Also, please keep in mind the precautions and conditions set forth in the "Handling Guide for Semiconductor Devices," or "TOSHIBA Semiconductor Reliability Handbook" etc..
- The TOSHIBA products listed in this document are intended for usage in general electronics applications (computer, personal equipment, office equipment, measuring equipment, industrial robotics, domestic appliances, etc.). These TOSHIBA products are neither intended nor warranted for usage in equipment that requires extraordinarily high quality and/or reliability or a malfunction or failure of which may cause loss of human life or bodily injury ("Unintended Usage"). Unintended Usage include atomic energy control instruments, airplane or spaceship instruments, transportation instruments, traffic signal instruments, combustion control instruments, medical instruments, all types of safety devices, etc.. Unintended Usage of TOSHIBA products listed in this document shall be made at the customer's own risk.
- The information contained herein is presented only as a guide for the applications of our products. No responsibility is assumed by TOSHIBA CORPORATION for any infringements of intellectual property or other rights of the third parties which may result from its use. No license is granted by implication or otherwise under any intellectual property or other rights of TOSHIBA CORPORATION or others.
- The information contained herein is subject to change without notice.