

MITSUBISHI IGBT Module

MG800J2YS50A

High power switching applications

Motor control applications

- The electrodes are isolated from case.
- Enhancement-mode
- Thermal output terminal (TH)

Equivalent Circuit

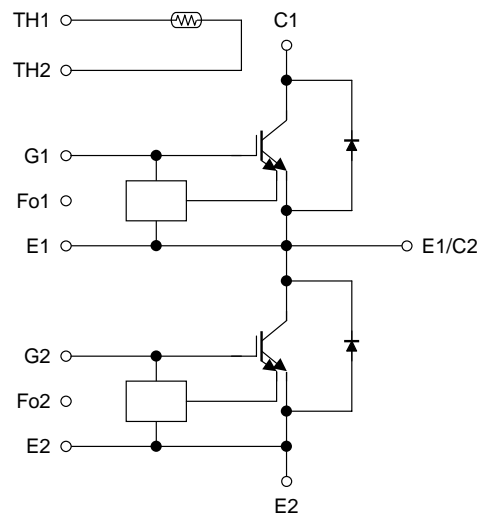

Maximum Ratings (Ta = 25°C)

Characteristics		Symbol	Rating	Unit
Collector-emitter voltage		V_{CES}	600	V
Gate-emitter voltage		V_{GES}	±20	V
Collector current	DC	I_C	800	A
Forward current	DC	I_F	800	A
Collector power dissipation (Tc = 25°C)		P_C	2900	W
Junction temperature		T_j	150	°C
Storage temperature range		T_{stg}	-40~125	°C
Isolation voltage		V_{isol}	2500 (AC 1 min)	V
Screw torque	Terminal: M8	—	10	N·m
	Mounting: M5	—	3	N·m

Electrical Characteristics (Ta = 25°C)

Characteristics	Symbol	Test Condition	Min	Typ.	Max	Unit	
Gate Leakage current	I_{GES}	$V_{GE} = \pm 20 \text{ V}, V_{CE} = 0 \text{ V}$	—	—	±10	μA	
Collector cut-off current	I_{CES}	$V_{CE} = 600 \text{ V}, V_{GE} = 0 \text{ V}$	—	—	1	mA	
Gate-emitter cut-off voltage	$V_{GE} \text{ (off)}$	$I_C = 800 \text{ mA}, V_{CE} = 5 \text{ V}$	5.0	6.5	8.0	V	
Collector-emitter saturation voltage	$V_{CE} \text{ (sat)}$	$I_C = 800 \text{ A}, V_{GE} = 15 \text{ V}$	$T_j = 25^\circ\text{C}$	—	2.4	3.0	V
			$T_j = 125^\circ\text{C}$	—	2.6	3.3	
Input capacitance	C_{ies}	$V_{CE} = 10 \text{ V}, V_{GE} = 0 \text{ V}, f = 1 \text{ MHz}$	—	93000	—	pF	
Gate-emitter voltage	V_{GE}	—	13	15	17	V	
Gate resistance	R_G	—	4.7	—	15	Ω	
Switching time	$t_d \text{ (on)}$	Inductive load $V_{CC} = 300 \text{ V}$ $I_C = 800 \text{ A}$ $V_{GE} = \pm 15 \text{ V}$ $R_G = 4.7 \text{ } \Omega$	(Note)	—	0.3	—	μs
	t_r			—	0.25	—	
	t_{on}			—	0.55	—	
	$t_d \text{ (off)}$			—	0.85	—	
	t_f			—	0.15	0.30	
	t_{off}			—	1.05	—	
Forward voltage	VF	$I_F = 800 \text{ A}, V_{GE} = 0 \text{ V}$	$T_j = 25^\circ\text{C}$	—	2.3	3.0	V
			$T_j = 125^\circ\text{C}$	—	2.1	—	
Reverse recovery time	trr	$I_F = 800 \text{ A}, V_{GE} = -10 \text{ V}$ $di/dt = 2000 \text{ A}/\mu\text{s}$	—	—	0.5	μs	
Thermal resistance	Rth (j-c)	Transistor stage	—	—	0.043	C/W	
		Diode stage	—	—	0.056		
RTC Operating current	Irtc	$T_j = 25^\circ\text{C}$	1600	—	—	A	

Thermistor

Characteristics	Symbol	Test Condition	Min	Typ.	Max	Unit
Zero power resistance	R25	$T_c = 25^\circ\text{C}$	—	100	—	k Ω
B value	R25/85	$T_c = 25^\circ\text{C}/T_c = 85^\circ\text{C}$	—	4390	—	K
Isolation voltage		$T_c = 25^\circ\text{C}$	2500	—	—	Vrms

Note: Switching time measurement circuit and input/output waveforms

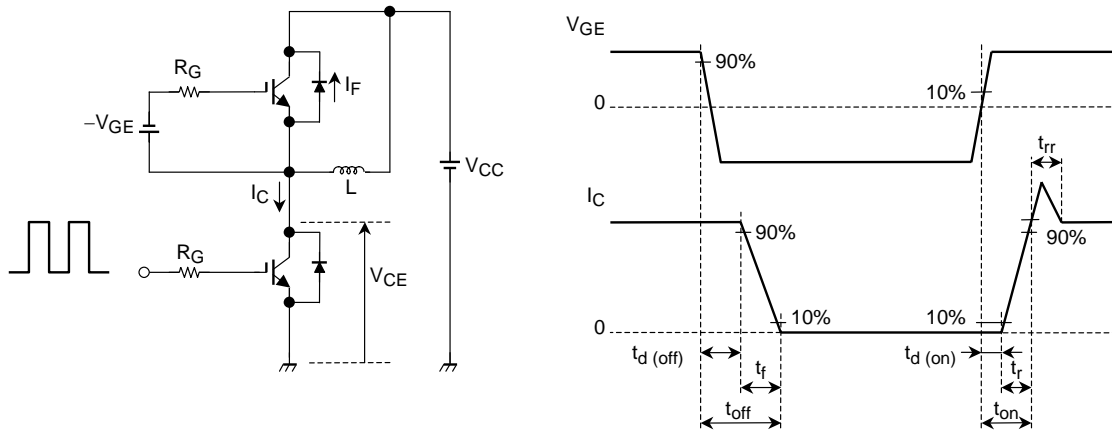

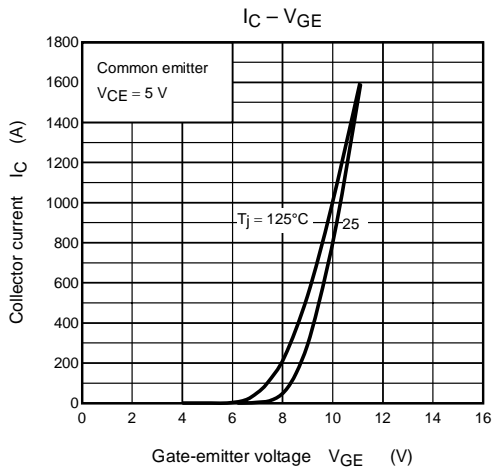
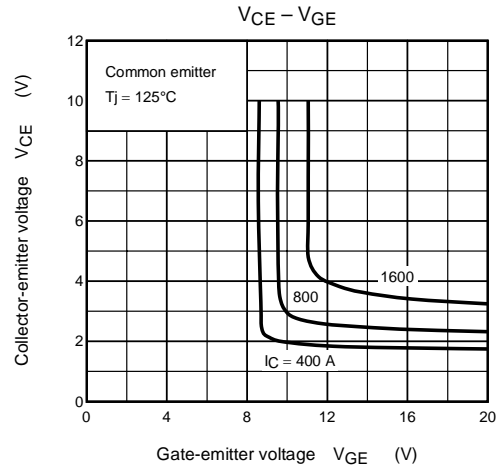
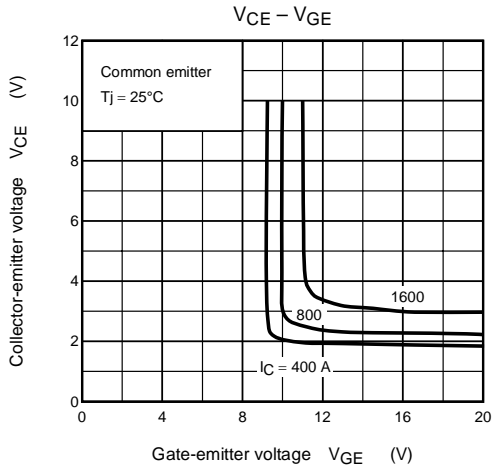
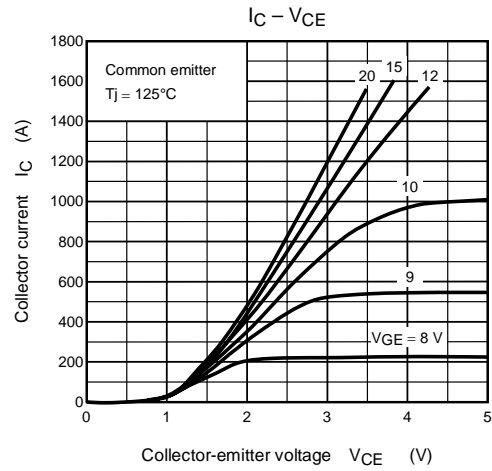
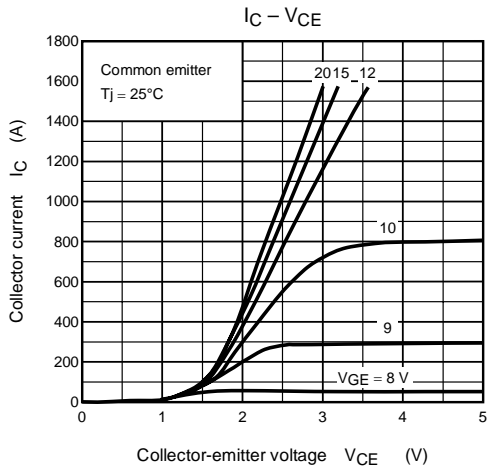

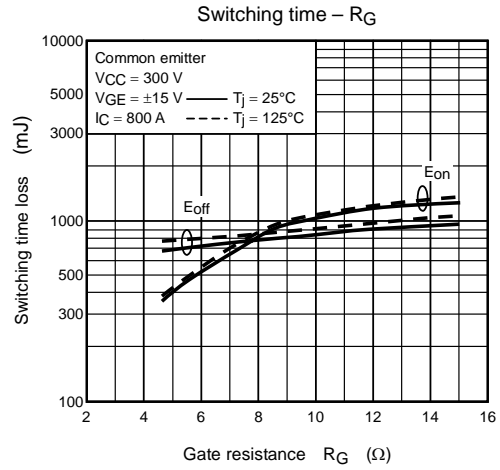
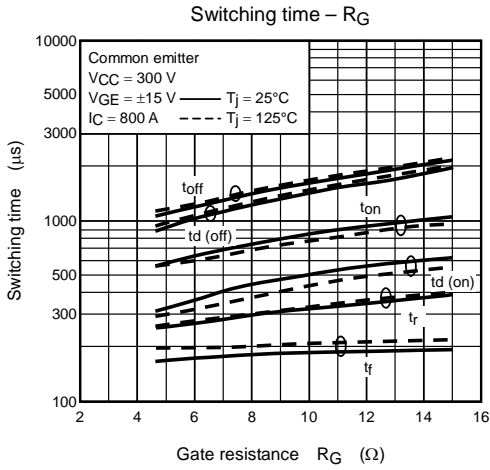
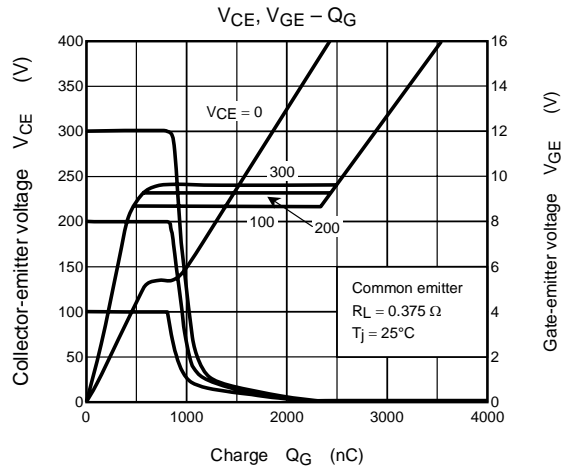
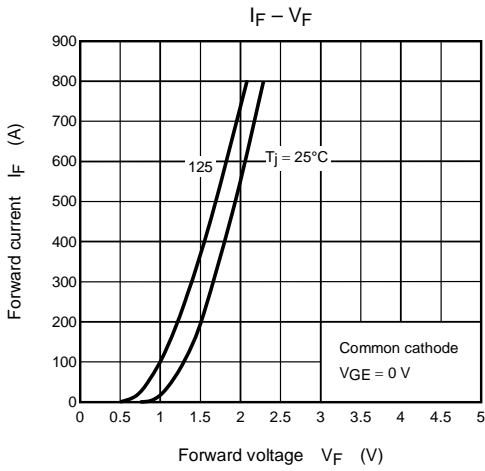

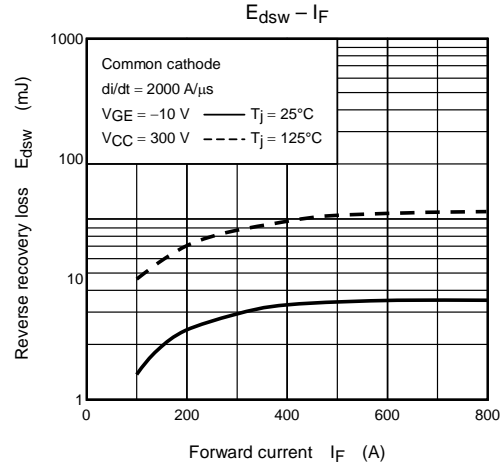
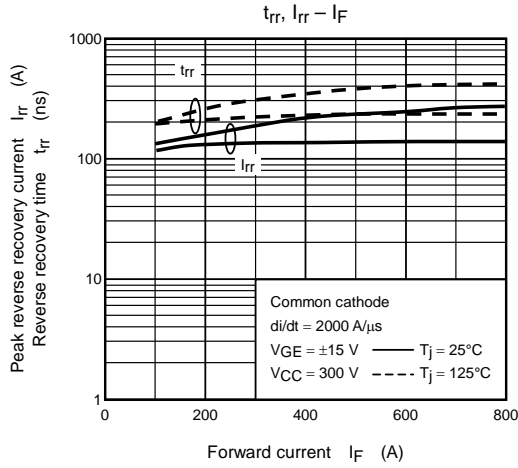
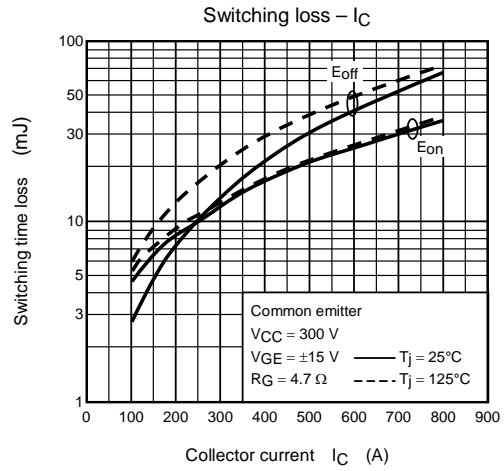
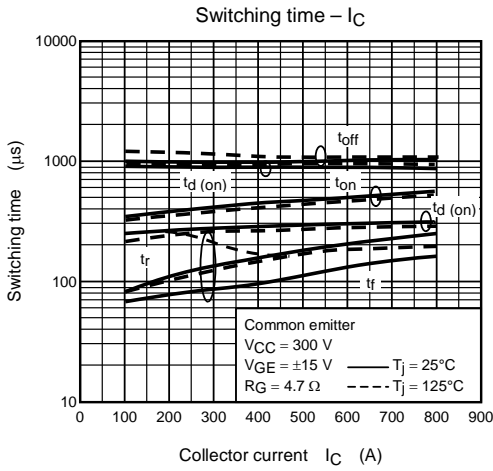

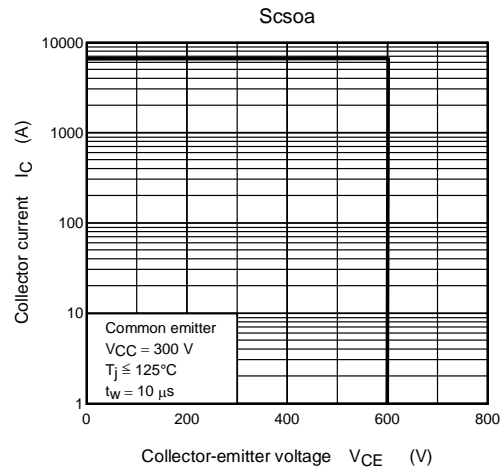
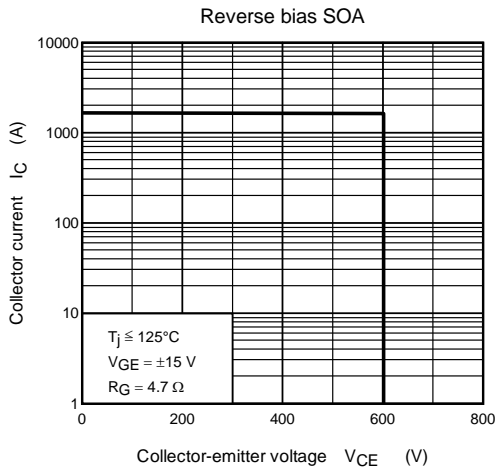
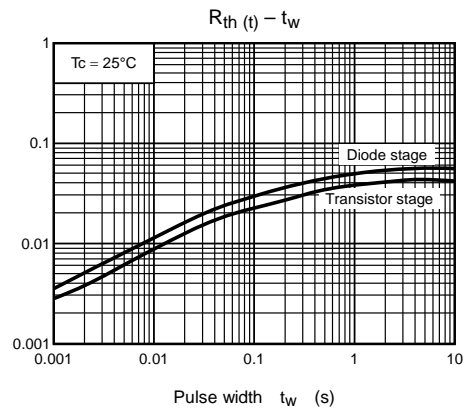
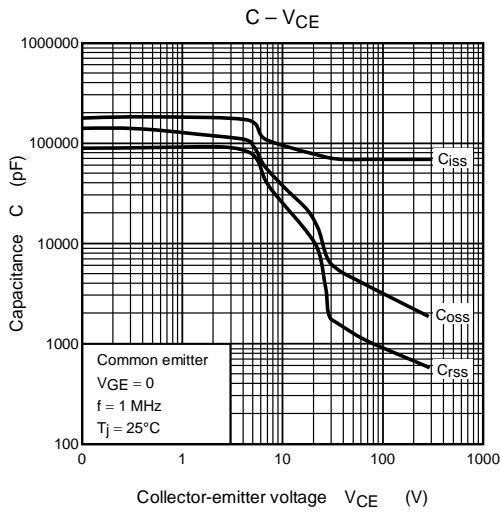

<V_{CE(sat)} Rank>

V_{CE(sat)}

Rank Symbol	Min.	Max.
21	1.8	2.1
22	1.9	2.2
23	2.0	2.3
24	2.1	2.4
25	2.2	2.5
26	2.3	2.6
27	2.4	2.7
28	2.5	2.8
29	2.6	2.9
30	2.7	3.0

<V_F Rank>

V_F

Rank Symbol	Min.	Max.
B	1.5	1.8
C	1.7	2.0
D	1.9	2.2
E	2.1	2.4
F	2.3	2.6
G	2.5	2.8
H	2.7	3.0

<Mark Position>

