

Fast Recovery Epitaxial Diode (FRED) Module

MEA 75-12 DA
MEK 75-12 DA
MEE 75-12 DA

$V_{RRM} = 1200\text{ V}$
 $I_{FAV} = 75\text{ A}$
 $t_{rr} = 250\text{ ns}$

Preliminary data

V_{RSM} V	V_{RRM} V	Type
1200	1200	<div style="display: flex; justify-content: space-around;"> <div style="text-align: center;"> <p>MEA75-12 DA</p> </div> <div style="text-align: center;"> <p>MEK 75-12 DA</p> </div> <div style="text-align: center;"> <p>MEE 75-12 DA</p> </div> </div>

TO-240 AA

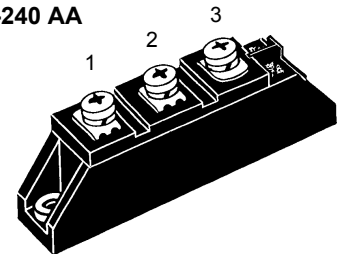

Symbol	Test Conditions	Maximum Ratings
I_{FRMS}	$T_{case} = 75\text{ }^\circ\text{C}$	107 A
I_{FAV}	$T_{case} = 75\text{ }^\circ\text{C}$; rectangular, $d = 0.5$	75 A
I_{FRM}	$t_p < 10\text{ }\mu\text{s}$; rep. rating, pulse width limited by T_{VJM}	TBD A
I_{FSM}	$T_{VJ} = 45\text{ }^\circ\text{C}$; $t = 10\text{ ms}$ (50 Hz), sine	1200 A
	$t = 8.3\text{ ms}$ (60 Hz), sine	1300 A
	$T_{VJ} = 150\text{ }^\circ\text{C}$; $t = 10\text{ ms}$ (50 Hz), sine	1080 A
	$t = 8.3\text{ ms}$ (60 Hz), sine	1170 A
I^2t	$T_{VJ} = 45\text{ }^\circ\text{C}$; $t = 10\text{ ms}$ (50 Hz), sine	7200 A ² s
	$t = 8.3\text{ ms}$ (60 Hz), sine	7100 A ² s
	$T_{VJ} = 150\text{ }^\circ\text{C}$; $t = 10\text{ ms}$ (50 Hz), sine	5800 A ² s
	$t = 8.3\text{ ms}$ (60 Hz), sine	5700 A ² s
T_{VJ}		-40...+150 $^\circ\text{C}$
T_{stg}		-40...+125 $^\circ\text{C}$
T_{Hmax}		110 $^\circ\text{C}$
P_{tot}	$T_{case} = 25\text{ }^\circ\text{C}$	280 W
V_{ISOL}	50/60 Hz, RMS $t = 1\text{ min}$	3000 V~
	$I_{ISOL} \leq 1\text{ mA}$ $t = 1\text{ s}$	3600 V~
M_d	Mounting torque (M5)	2.50-4/22-35 Nm/lb.in.
	Terminal connection torque (M5)	2.50-4/22-35 Nm/lb.in.
d_s	Creep distance on surface	12.7 mm
d_A	Strike distance through air	9.6 mm
a	Maximum allowable acceleration	50 m/s ²
Weight		90 g

Features

- International standard package with DCB ceramic base plate
- Planar passivated chips
- Short recovery time
- Low switching losses
- Soft recovery behaviour
- Isolation voltage 3600 V~
- UL registered E 72873

Applications

- Antiparallel diode for high frequency switching devices
- Free wheeling diode in converters and motor control circuits
- Inductive heating and melting
- Uninterruptible power supplies (UPS)
- Ultrasonic cleaners and welders

Advantages

- High reliability circuit operation
- Low voltage peaks for reduced protection circuits
- Low noise switching
- Low losses

Symbol	Test Conditions	Characteristic Values (per diode)		
		typ.	max.	
I_R	$T_{VJ} = 25\text{ }^\circ\text{C}$ $V_R = V_{RRM}$		2 mA	
	$T_{VJ} = 25\text{ }^\circ\text{C}$ $V_R = 0.8 \cdot V_{RRM}$		0.5 mA	
	$T_{VJ} = 125\text{ }^\circ\text{C}$ $V_R = 0.8 \cdot V_{RRM}$		34 mA	
V_F	$I_F = 100\text{ A}$; $T_{VJ} = 125\text{ }^\circ\text{C}$		1.85 V	
	$T_{VJ} = 25\text{ }^\circ\text{C}$		2.17 V	
	$I_F = 300\text{ A}$; $T_{VJ} = 125\text{ }^\circ\text{C}$		2.58 V	
	$T_{VJ} = 25\text{ }^\circ\text{C}$		2.64 V	
V_{T0}	For power-loss calculations only		1.48 V	
r_T			3.65 m Ω	
R_{thJH}	DC current		0.550 K/W	
R_{thJC}	DC current		0.450 K/W	
t_{rr} I_{RM}	$I_F = 150\text{ A}$ $V_R = 600\text{ V}$ $-di/dt = 200\text{ A}/\mu\text{s}$	250	$T_{VJ} = 100\text{ }^\circ\text{C}$	300 ns
			$T_{VJ} = 25\text{ }^\circ\text{C}$	22 A
			$T_{VJ} = 100\text{ }^\circ\text{C}$	33 A

Dimensions in mm (1 mm = 0.0394")

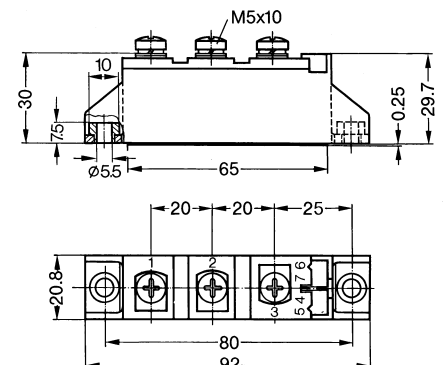

Data according to IEC 60747
 IXYS reserves the right to change limits, test conditions and dimensions

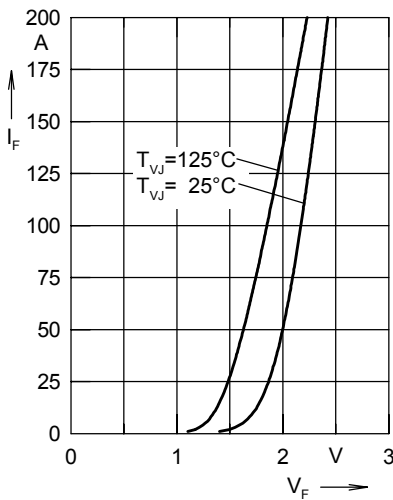

Fig. 1 Forward current I_F versus voltage drop V_F per leg

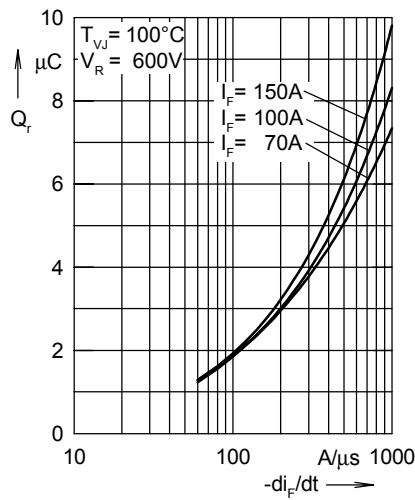

Fig. 2 Reverse recovery charge Q_r versus $-di_F/dt$

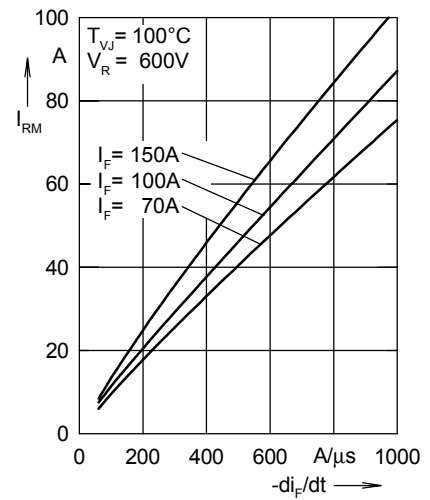

Fig. 3 Peak reverse current I_{RM} versus $-di_F/dt$

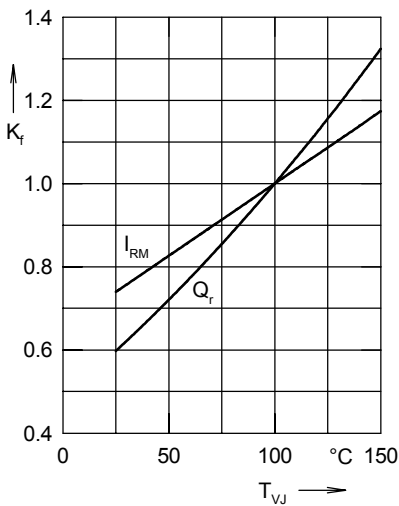

Fig. 4 Dynamic parameters Q_r , I_{RM} versus junction temperature T_{VJ}

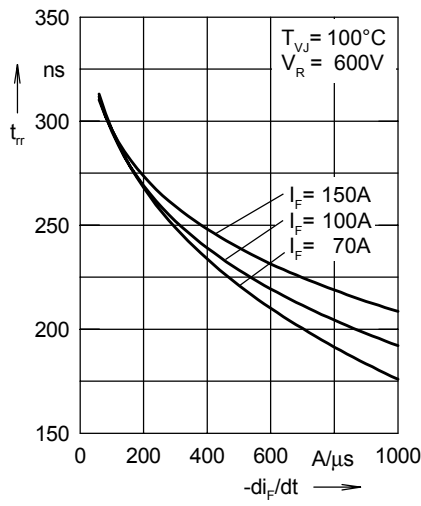

Fig. 5 Recovery time t_{tr} versus $-di_F/dt$

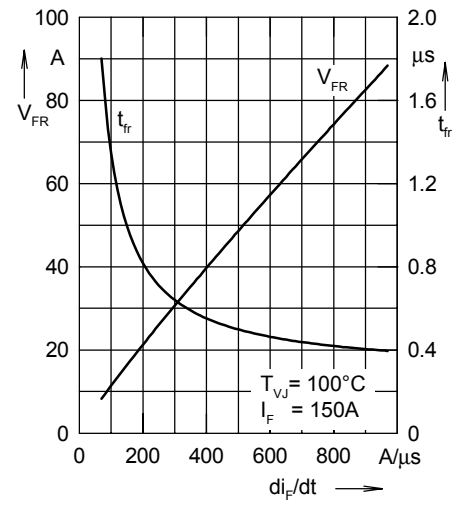

Fig. 6 Peak forward voltage V_{FR} and t_{tr} versus di_F/dt

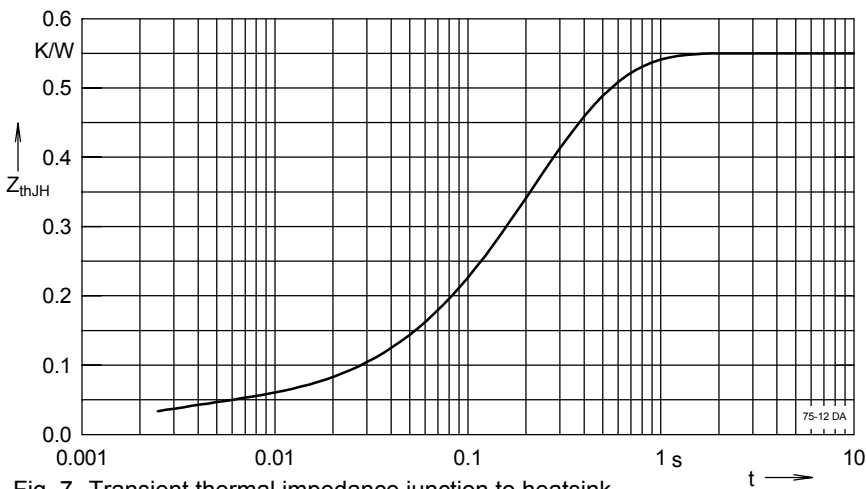

Fig. 7 Transient thermal impedance junction to heatsink

Constants for Z_{thJH} calculation:

i	R_{thi} (K/W)	t_i (s)
1	0.037	0.002
2	0.138	0.134
3	0.093	0.25
4	0.282	0.274