

# Fast Recovery Epitaxial Diode (FRED) Module

MEA 300-06 DA  
MEK 300-06 DA  
MEE 300-06 DA

$V_{RRM} = 600\text{ V}$   
 $I_{FAVM} = 304\text{ A}$   
 $t_{rr} = 250\text{ ns}$

Preliminary data

$V_{RSM}$ V	$V_{RRM}$ V	Type
600	600	<div style="display: flex; justify-content: space-around;"> <div style="text-align: center;"> <p>MEK 300-06DA</p> </div> <div style="text-align: center;"> <p>MEK 300-06DA</p> </div> <div style="text-align: center;"> <p>MEE 300-06DA</p> </div> </div>

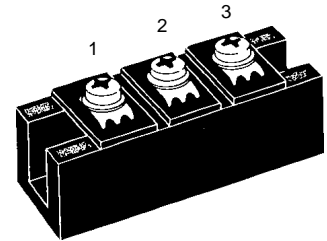

Symbol	Test Conditions	Maximum Ratings
$I_{FRMS}$	$T_C = 75\text{ }^\circ\text{C}$	430 A
$I_{FAVM}$ ①	$T_C = 75\text{ }^\circ\text{C}$ ; rectangular, $d = 0.5$	304 A
$I_{FRM}$	$t_p < 10\text{ }\mu\text{s}$ ; rep. rating, pulse width limited by $T_{VJM}$	1640 A
$I_{FSM}$	$T_{VJ} = 45\text{ }^\circ\text{C}$ ; $t = 10\text{ ms}$ (50 Hz), sine	2400 A
	$t = 8.3\text{ ms}$ (60 Hz), sine	2640 A
	$T_{VJ} = 150\text{ }^\circ\text{C}$ ; $t = 10\text{ ms}$ (50 Hz), sine	2160 A
	$t = 8.3\text{ ms}$ (60 Hz), sine	2380 A
$I^2t$	$T_{VJ} = 45\text{ }^\circ\text{C}$ ; $t = 10\text{ ms}$ (50 Hz), sine	28800 A <sup>2</sup> s
	$t = 8.3\text{ ms}$ (60 Hz), sine	29300 A <sup>2</sup> s
	$T_{VJ} = 150\text{ }^\circ\text{C}$ ; $t = 10\text{ ms}$ (50 Hz), sine	23300 A <sup>2</sup> s
	$t = 8.3\text{ ms}$ (60 Hz), sine	23800 A <sup>2</sup> s
$T_{VJ}$		-40...+150 $^\circ\text{C}$
$T_{stg}$		-40...+125 $^\circ\text{C}$
$T_{Smax}$		110 $^\circ\text{C}$
$P_{tot}$	$T_C = 25\text{ }^\circ\text{C}$	875 W
$V_{ISOL}$	50/60 Hz, RMS $t = 1\text{ min}$	3000 V~
	$I_{ISOL} \leq 1\text{ mA}$ $t = 1\text{ s}$	3600 V~
$M_d$	Mounting torque (M6)	2.25-2.75/20-25 Nm/lb.in.
	Terminal connection torque (M6)	4.50-5.50/40-48 Nm/lb.in.
$d_s$	Creeping distance on surface	12.7 mm
$d_A$	Strike distance through air	9.6 mm
$a$	Maximum allowable acceleration	50 m/s <sup>2</sup>
<b>Weight</b>		150 g

## Features

- International standard package with DCB ceramic base plate
- Planar passivated chips
- Short recovery time
- Low switching losses
- Soft recovery behaviour
- Isolation voltage 3600 V~
- UL registered E 72873

## Applications

- Antiparallel diode for high frequency switching devices
- Free wheeling diode in converters and motor control circuits
- Inductive heating and melting
- Uninterruptible power supplies (UPS)
- Ultrasonic cleaners and welders

## Advantages

- High reliability circuit operation
- Low voltage peaks for reduced protection circuits
- Low noise switching
- Low losses

## Dimensions in mm (1 mm = 0.0394")

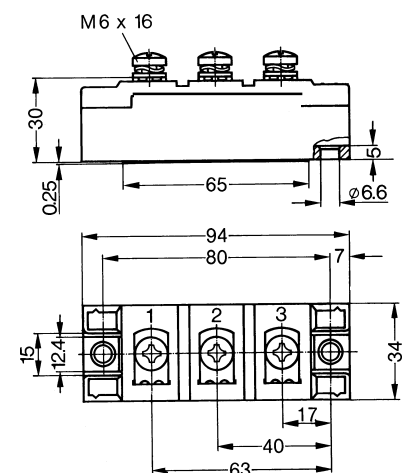

①  $I_{FAVM}$  rating includes reverse blocking losses at  $T_{VJM}$ ,  $V_R = 0.6 V_{RRM}$ , duty cycle  $d = 0.5$

Data according to IEC 60747

IXYS reserves the right to change limits, test conditions and dimensions

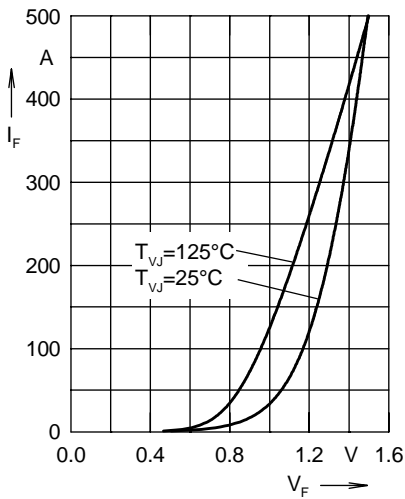

Fig. 1 Forward current  $I_F$  versus max. voltage drop  $V_F$  per leg

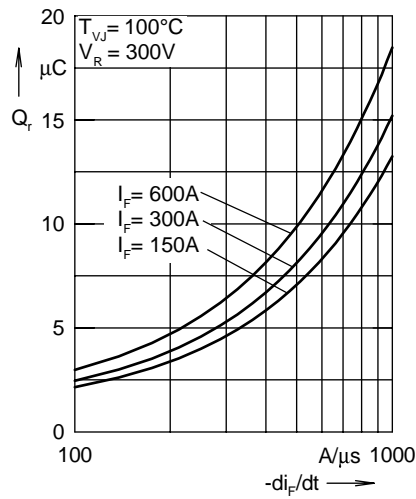

Fig. 2 Typ. reverse recovery charge  $Q_r$  versus  $-di_F/dt$

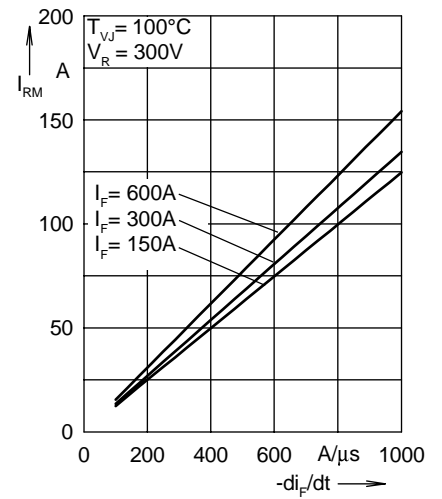

Fig. 3 Typ. peak reverse current  $I_{RM}$  versus  $-di_F/dt$

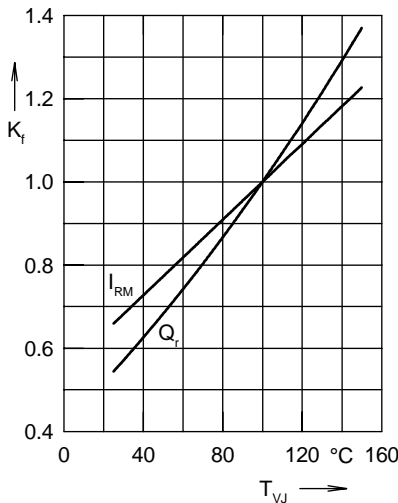

Fig. 4 Dynamic parameters  $Q_r$ ,  $I_{RM}$  versus junction temperature  $T_{VJ}$

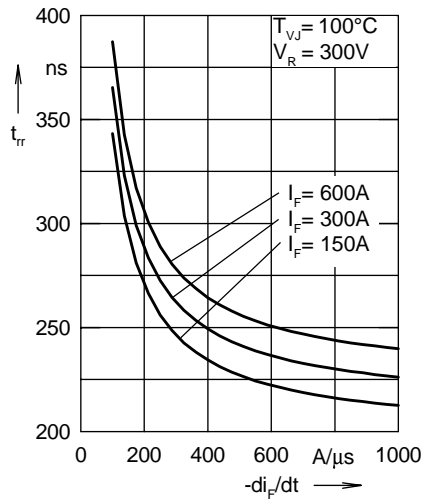

Fig. 5 Typ. recovery time  $t_{tr}$  versus  $-di_F/dt$

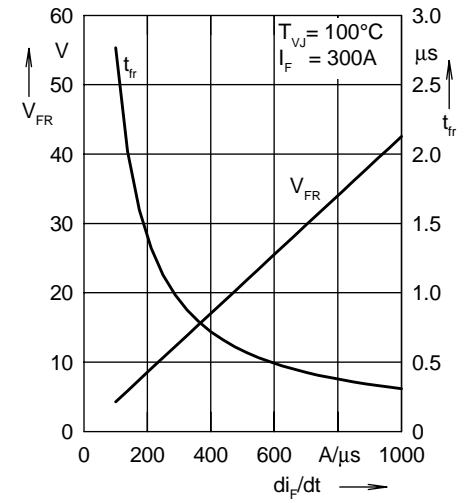

Fig. 6 Typ. peak forward voltage  $V_{FR}$  and  $t_{tr}$  versus  $di_F/dt$

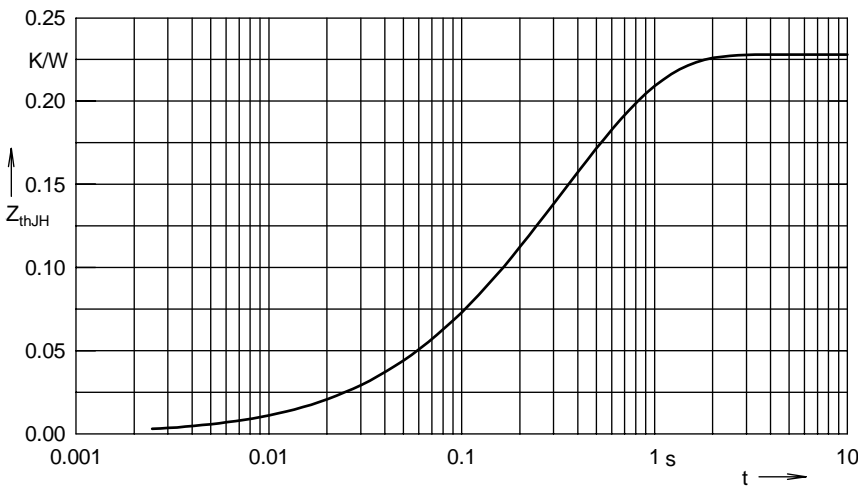

Fig. 7 Transient thermal impedance junction to heatsink

Constants for  $Z_{thJS}$  calculation:

i	$R_{thi}$ (K/W)	$t_i$ (s)
1	0.002	0.08
2	0.008	0.024
3	0.054	0.112
4	0.164	0.464