

Numerical Control (CNC)

Specifications and Instruction Manual

MDS-C1-N Series

Introduction

Thank you for selecting the Mitsubishi numerical control unit. This instruction manual describes the handling and caution points for using this AC servo/spindle. Incorrect handling may lead to unforeseen accidents, so always read this instruction manual thoroughly to ensure correct usage.

Make sure that this instruction manual is delivered to the end user. Always store this manual in a safe place.

In order to confirm if all function specifications described in this manual are applicable, refer to the specifications for each CNC.

Notes on Reading This Manual

- (1) Since the description of this specification manual deals with NC in general, for the specifications of individual machine tools, refer to the manuals issued by the respective machine tool builders. The "restrictions" and "available functions" described in the manuals issued by the machine tool builders have precedence to those in this manual.
- (2) This manual describes as many special operations as possible, but it should be kept in mind that items not mentioned in this manual cannot be performed.

In this manual, the following abbreviations might be used.

MTB: Machine tool builder

Precautions for Safety

Please read this manual and auxiliary documents before starting installation, operation, maintenance or inspection to ensure correct usage. Thoroughly understand the device, safety information and precautions before starting operation.

The safety precautions in this instruction manual are ranked as "WARNING" and "CAUTION".

DANGER

When there is a potential risk of fatal or serious injuries if handling is mistaken.

WARNING



When a dangerous situation, or fatal or serious injuries may occur if handling is mistaken.



CAUTION

When a dangerous situation may occur if handling is mistaken leading to medium or minor injuries, or physical damage.











Note that some items described as " CAUTION" may lead to major results depending on the situation. In any case, important information that must be observed is described.

The signs indicating prohibited and mandatory matters are explained below.

	Indicates a prohibited matter. For example, "Fire Prohibited" is indicated as .
---	---

	Indicates a mandatory matter. For example, grounding is indicated as .
---	--

The meaning of each pictorial sign is as follows.

 CAUTION	 CAUTION rotated object	 CAUTION HOT	 Danger Electric shock risk	 Danger explosive
 Prohibited	 Disassembly is prohibited	 KEEP FIRE AWAY	 General instruction	 Earth ground

After reading this specifications and instructions manual, store it where the user can access it easily for reference.

The numeric control unit is configured of the control unit, operation board, servo drive unit, spindle drive unit, power supply, servo motor and spindle motor, etc.

In this section "Precautions for safety", the following items are generically called the "motor".

- Servo motor
- Linear servo motor
- Spindle motor
- Direct-drive motor

In this section "Precautions for safety", the following items are generically called the "unit".

- Servo drive unit
- Spindle drive unit
- Power supply unit
- Scale interface unit
- Magnetic pole detection unit



POINT

Important matters that should be understood for operation of this machine are indicated as a POINT in this manual.













For Safe Use

Mitsubishi CNC is designed and manufactured solely for applications to machine tools to be used for industrial purposes.

Do not use this product in any applications other than those specified above, especially those which are substantially influential on the public interest or which are expected to have significant influence on human lives or properties.



 **WARNING**

1. Electric shock prevention

-  Do not open the front cover while the power is ON or during operation. Failure to observe this could lead to electric shocks.
-  Do not operate the unit with the front cover removed. The high voltage terminals and charged sections will be exposed, and can cause electric shocks.
-  Do not remove the front cover and connector even when the power is OFF unless carrying out wiring work or periodic inspections. The inside of the units is charged, and can cause electric shocks.
-  Since the high voltage is supplied to the main circuit connector while the power is ON or during operation, do not touch the main circuit connector with an adjustment screwdriver or the pen tip. Failure to observe this could lead to electric shocks.
-  Wait at least 15 minutes after turning the power OFF, confirm that the CHARGE lamp has gone out, and check the voltage between P and N terminals with a tester, etc., before starting wiring, maintenance or inspections. Failure to observe this could lead to electric shocks.
-  Ground the unit and motor. For the motor, ground it via the drive unit.
-  Wiring, maintenance and inspection work must be done by a qualified technician.
-  Wire the servo drive unit and servo motor after installation. Failure to observe this could lead to electric shocks.
-  Do not touch the switches with wet hands. Failure to observe this could lead to electric shocks.
-  Do not damage, apply forcible stress, place heavy items on the cables or get them caught. Failure to observe this could lead to electric shocks.
-  Always insulate the power terminal connection section. Failure to observe this could lead to electric shocks.
-  After assembling the built-in IPM spindle motor, if the rotor is rotated by hand etc., voltage occurs between the terminals of lead. Take care not to get electric shocks.

 **WARNING**

2. Injury prevention

-  **When handling a motor, perform operations in safe clothing.**
-  **In the system where the optical communication with CNC is executed, do not see directly the light generated from CN1A/CN1B connector of drive unit or the end of cable. When the light gets into eye, you may feel something is wrong for eye.**
(The light source of optical communication corresponds to class1 defined in JISC6802 or IEC60825-1.)
-  **The linear servo motor, direct-drive motor and built-in IPM spindle motor uses permanent magnets in the rotor, so observe the following precautions.**

(1) Handling

- The linear servo motor, direct-drive motor and built-in IPM spindle motor could adversely affect medical electronics such as pacemakers, etc., therefore, do not approach the rotor.
- Do not place magnetic materials as iron.
- When a magnetic material as iron is placed, take safety measure not to pinch fingers or hands due to the magnetic attraction force.
- Remove metal items such as watch, piercing jewelry, necklace, etc.
- Do not place portable items that could malfunction or fail due to the influence of the magnetic force.
- When the rotor is not securely fixed to the machine or device, do not leave it unattended but store it in the package properly.
- When installing the motor to the machine, take it out from the package one by one, and then install it.
- It is highly dangerous to lay out the motor or magnetic plates together on the table or pallet, therefore never do so.

(2) Transportation and storage







- Correctly store the rotor in the package to transport and store.
- During transportation and storage, draw people's attention by applying a notice saying "Strong magnet-Handle with care" to the package or storage shelf.
- Do not use a damaged package.

(3) Installation







- Take special care not to pinch fingers, etc., when installing (and unpacking) the linear servo motor.

 **CAUTION**

1. Fire prevention

-  **Install the units, motors and regenerative resistor on non-combustible material. Direct installation on combustible material or near combustible materials could lead to fires.**
-  **Always install a circuit protector and contactor on the servo drive unit power input as explained in this manual. Refer to this manual and select the correct circuit protector and contactor. An incorrect selection could result in fire.**
-  **Shut off the power on the unit side if a fault occurs in the units. Fires could be caused if a large current continues to flow.**
-  **When using a regenerative resistor, provide a sequence that shuts off the power with the regenerative resistor's error signal. The regenerative resistor could abnormally overheat and cause a fire due to a fault in the regenerative transistor, etc.**
-  **The battery unit could heat up, ignite or rupture if submerged in water, or if the poles are incorrectly wired.**
-  **Cut off the main circuit power with the contactor when an alarm or emergency stop occurs.**

2. Injury prevention

-  **Do not apply a voltage other than that specified in this manual, on each terminal. Failure to observe this item could lead to ruptures or damage, etc.**
-  **Do not mistake the terminal connections. Failure to observe this item could lead to ruptures or damage, etc.**
-  **Do not mistake the polarity (+,-). Failure to observe this item could lead to ruptures or damage, etc.**
-  **Do not touch the radiation fin on unit back face, regenerative resistor or motor, etc., or place parts (cables, etc.) while the power is turned ON or immediately after turning the power OFF. These parts may reach high temperatures, and can cause burns or part damage.**
-  **Structure the cooling fan on the unit back face, etc., etc so that it cannot be touched after installation. Touching the cooling fan during operation could lead to injuries.**
-  **Take care not to suck hair, clothes, etc. into the cooling fan.**

⚠ CAUTION

3. Various precautions

Observe the following precautions. Incorrect handling of the unit could lead to faults, injuries and electric shocks, etc.

(1) Transportation and installation

- ⚠ Correctly transport the product according to its weight.
- ❗ Use the motor's hanging bolts only when transporting the motor. Do not transport the machine when the motor is installed on the machine.
- ⚠ Do not stack the products above the tolerable number.
- ⚠ Follow this manual and install the unit or motor in a place where the weight can be borne.
- ⚠ Do not get on top of or place heavy objects on the unit.

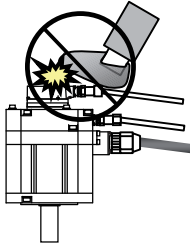

- ⚠ Do not hold the cables, axis or encoder when transporting the motor.

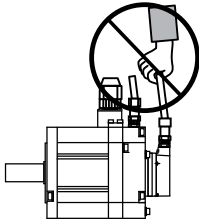

- ⚠ Do not hold the connected wires or cables when transporting the units.
- ⚠ Do not hold the front cover when transporting the unit. The unit could drop.
- ⚠ Always observe the installation directions of the units or motors.
- ⚠ Secure the specified distance between the units and control panel, or between the servo drive unit and other devices.
- ⚠ Do not install or run a unit or motor that is damaged or missing parts.
- ⚠ Do not block the intake or exhaust ports of the motor provided with a cooling fan.
- ⚠ Do not let foreign objects enter the units or motors. In particular, if conductive objects such as screws or metal chips, etc., or combustible materials such as oil enter, rupture or breakage could occur.
- ⚠ Provide adequate protection using a material such as connector for conduit to prevent screws, metallic detritus, water and other conductive matter or oil and other combustible matter from entering the motor through the power line lead-out port.
- ⚠ The units, motors and encoders are precision devices, so do not drop them or apply strong impacts to them.

⚠ CAUTION

⚠ Store and use the units under the following environment conditions.

Environment	Unit	Servo motor	Spindle motor
Ambient temperature	Operation: 0 to +55°C (with no freezing), Storage / Transportation: -15°C to +70°C (with no freezing)	Operation: 0 to +40°C (with no freezing), Storage: -15°C to +70°C (Note 2) (with no freezing)	Operation: 0 to +40°C (with no freezing), Storage: -20°C to +65°C (with no freezing)
Ambient humidity	Operation: 90%RH or less (with no dew condensation) Storage / Transportation: 90%RH or less (with no dew condensation)	Operation: 80%RH or less (with no dew condensation), Storage: 90%RH or less (with no dew condensation)	Operation: 90%RH or less (with no dew condensation) Storage: 90%RH or less (with no dew condensation)
Atmosphere	Indoors (no direct sunlight) With no corrosive gas, inflammable gas, oil mist, dust or conductive fine particles		
Altitude	Operation/Storage: 1000 meters or less above sea level, Transportation: 13000 meters or less above sea level	Operation/Storage: 1000 meters or less above sea level, Transportation: 10000 meters or less above sea level	
Vibration/impact	According to each unit or motor specification		

(Note 1) For details, confirm each unit or motor specifications in addition.

(Note 2) -15°C to +55°C for linear servo motor.

- ⚠ When disinfectants or insecticides must be used to treat wood packaging materials, always use methods other than fumigation (for example, apply heat treatment at the minimum wood core temperature of 56 °C for a minimum duration of 30 minutes (ISPM No. 15 (2009))).**
If products such as units are directly fumigated or packed with fumigated wooden materials, halogen substances (including fluorine, chlorine, bromine and iodine) contained in fumes may contribute to the erosion of the capacitors.
When exporting the products, make sure to comply with the laws and regulations of each country.
- ⚠ Do not use the products in conjunction with any components that contain halogenated flame retardants (bromine, etc). Failure to observe this may cause the erosion of the capacitors.**
- ⚠ Securely fix the servo motor to the machine. Insufficient fixing could lead to the servo motor slipping off during operation.**
- ⚠ Always install the servo motor with reduction gear in the designated direction. Failure to do so could lead to oil leaks.**
- ⚠ Structure the rotary sections of the motor so that it can never be touched during operation. Install a cover, etc., on the shaft.**
- ⚠ When installing a coupling to a servo motor shaft end, do not apply an impact by hammering, etc. The encoder could be damaged.**
- ⚠ Do not apply a load exceeding the tolerable load onto the servo motor shaft. The shaft could break.**
- ⚠ Store the motor in the package box.**
- ⚠ When inserting the shaft into the built-in IPM spindle motor, do not heat the rotor higher than 130°C. The magnet could be demagnetized, and the specifications characteristics will not be ensured.**
- ⚠ Always use a nonmagnetic tool (explosion-proof beryllium copper alloy safety tool: NGK Insulators, etc.) when installing the built-in IPM spindle motor, direct-drive motor and linear servo motor.**
- ⚠ Always provide a mechanical stopper on the end of the linear servo motor's travel path.**
- ❗ If the unit has been stored for a long time, always check the operation before starting actual operation. Please contact the Service Center, Service Station, Sales Office or delayer.**
- ⚠ Install the heavy peripheral devices to the lower part in the panel and securely fix it not to be moved due to vibration.**

⚠ CAUTION

(2) Wiring

- ⚠ Correctly and securely perform the wiring. Failure to do so could lead to abnormal operation of the motor.
- ⚠ Do not install a condensing capacitor, surge absorber or radio noise filter on the output side of the drive unit.
- ⚠ Correctly connect the output side of the drive unit (terminals U, V, W). Failure to do so could lead to abnormal operation of the motor.
- ⚠ When using a power regenerative power supply unit, always install an AC reactor for each power supply unit.
- ⚠ In the main circuit power supply side of the unit, always install an appropriate circuit protector or contactor for each unit. Circuit protector or contactor cannot be shared by several units.
- ⚠ Always connect the motor to the drive unit's output terminals (U, V, W).
- ⚠ Do not directly connect a commercial power supply to the servo motor. Failure to observe this could result in a fault.
- ⚠ When using an inductive load such as a relay, always connect a diode as a noise measure parallel to the load.
- ⚠ When using a capacitance load such as a lamp, always connect a protective resistor as a noise measure serial to the load.

- ⚠ Do not reverse the direction of a diode which connect to a DC relay for the control output signals such as contractor and motor brake output, etc. to suppress a surge. Connecting it backwards could cause the drive unit to malfunction so that signals are not output, and emergency stop and other safety circuits are inoperable.

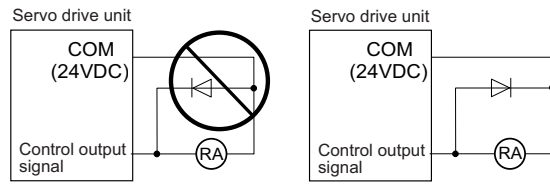

- ⚠ Do not connect/disconnect the cables connected between the units while the power is ON.
- ⚠ Securely tighten the cable connector fixing screw or fixing mechanism. An insecure fixing could cause the cable to fall off while the power is ON.
- ⚠ When using a shielded cable instructed in the instruction manual, always ground the cable with a cable clamp, etc. (Refer to "EMC Installation Guidelines")
- ⚠ Always separate the signals wires from the drive wire and power line.
- ⚠ Use wires and cables that have a wire diameter, heat resistance and flexibility that conforms to the system.

(3) Trial operation and adjustment

- ⚠ Check and adjust each program and parameter before starting operation. Failure to do so could lead to unforeseen operation of the machine.
- ⚠ Do not make remarkable adjustments and changes of parameter as the operation could become unstable.
- ⚠ The usable motor and unit combination is predetermined. Always check the combinations and parameters before starting trial operation.
- ⚠ The direct-drive motor and linear servo motor do not have a stopping device such as magnetic brakes. Install a stopping device on the machine side.
- ⚠ When using the linear servo motor for an unbalance axis, adjust the unbalance weight to 0 by installing an air cylinder, etc. on the machine side. The unbalance weight disables the initial magnetic pole adjustment.

⚠ CAUTION

(4) Usage methods

- ❗ In abnormal state, install an external emergency stop circuit so that the operation can be stopped and power shut off immediately.
- ⚠ Turn the power OFF immediately if smoke, abnormal noise or odors are generated from the unit or motor.
- ⊘ Do not disassemble or repair this product.
- ⚠ Never make modifications.
- ⚠ When an alarm occurs, the machine will start suddenly if an alarm reset (RST) is carried out while an operation start signal (ST) is being input. Always confirm that the operation signal is OFF before carrying out an alarm reset. Failure to do so could lead to accidents or injuries.
- ⚠ Reduce magnetic damage by installing a noise filter. The electronic devices used near the unit could be affected by magnetic noise. Install a line noise filter, etc., if there is a risk of magnetic noise.
- ⚠ Use the unit, motor and regenerative resistor with the designated combination. Failure to do so could lead to fires or trouble.
- ⊘ The brake (magnetic brake) of the servo motor are for holding, and must not be used for normal braking.
- ⚠ There may be cases when holding is not possible due to the magnetic brake's life, the machine construction (when ball screw and servo motor are coupled via a timing belt, etc.) or the magnetic brake's failure. Install a stop device to ensure safety on the machine side.
- ⚠ After changing the programs/parameters or after maintenance and inspection, always test the operation before starting actual operation.
- ⚠ Do not enter the movable range of the machine during automatic operation. Never place body parts near or touch the spindle during rotation.
- ⚠ Follow the power supply specification conditions given in each specification for the power (input voltage, input frequency, tolerable sudden power failure time, etc.).
- ⚠ Set all bits to "0" if they are indicated as not used or empty in the explanation on the bits.
- ⚠ Do not use the dynamic brakes except during the emergency stop. Continued use of the dynamic brakes could result in brake damage.
- ⚠ If a circuit protector for the main circuit power supply is shared by several units, the circuit protector may not activate when a short-circuit fault occurs in a small capacity unit. This is dangerous, so never share the circuit protector.
- ⚠ Mitsubishi spindle motor is dedicated to machine tools. Do not use for other purposes.





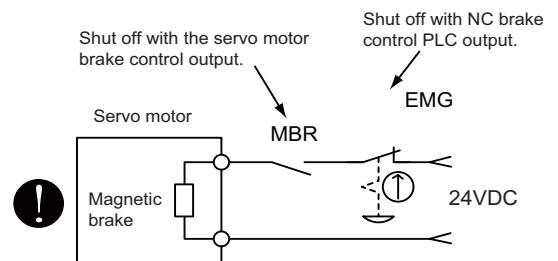

(5) Troubleshooting

- ⚠ If a hazardous situation is predicted during power failure or product trouble, use a servo motor with magnetic brakes or install an external brake mechanism.
- ⚠ Use a double circuit configuration that allows the operation circuit for the magnetic brakes to be operated even by the external emergency stop signal.
- ⚠ Always turn the main circuit power of the motor OFF when an alarm occurs.
- ⚠ If an alarm occurs, remove the cause, and secure the safety before resetting the alarm.







 **CAUTION**



(6) Maintenance, inspection and part replacement

-  Always backup the programs and parameters before starting maintenance or inspections.
-  The capacity of the electrolytic capacitor will drop over time due to self-discharging, etc. To prevent secondary disasters due to failures, replacing this part every five years when used under a normal environment is recommended. Contact the Service Center, Service Station, Sales Office or delayer for repairs or part replacement.
-  Do not perform a megger test (insulation resistance measurement) during inspections.
-  If the battery low warning is issued, immediately replace the battery. Replace the batteries while applying the drive unit's control power.
-  Do not short circuit, charge, overheat, incinerate or disassemble the battery.
-  For after-purchase servicing of the built-in motor, only the servicing parts for MITSUBISHI encoder can be supplied. For the motor body, prepare the spare parts at the machine tool builders.
-  For maintenance, part replacement, and services in case of failures in the built-in motor (including the encoder), take necessary actions at the machine tool builders. For drive unit, Mitsubishi can offer the after-purchase servicing as with the general drive unit.

(7) Disposal

-  Take the batteries and backlights for LCD, etc., off from the controller, drive unit and motor, and dispose of them as general industrial wastes.
-  Do not disassemble the unit or motor.
-  Dispose of the battery according to local laws.
-  Always return the secondary side (magnet side) of the linear servo motor to the Service Center or Service Station.
-  When incinerating optical communication cable, hydrogen fluoride gas or hydrogen chloride gas which is corrosive and harmful may be generated. For disposal of optical communication cable, request for specialized industrial waste disposal services that has incineration facility for disposing hydrogen fluoride gas or hydrogen chloride gas.

(8) Transportation

-  The unit and motor are precision parts and must be handled carefully.
-  According to a United Nations Advisory, the battery unit and battery must be transported according to the rules set forth by the International Civil Aviation Organization (ICAO), International Air Transportation Association (IATA), International Maritime Organization (IMO), and United States Department of Transportation (DOT), etc.

(9) General precautions

The drawings given in this manual show the covers and safety partitions, etc., removed to provide a clearer explanation. Always return the covers or partitions to their respective places before starting operation, and always follow the instructions given in this manual.

Treatment of waste

The following two laws will apply when disposing of this product. Considerations must be made to each law. The following laws are in effect in Japan. Thus, when using this product overseas, the local laws will have a priority. If necessary, indicate or notify these laws to the final user of the product.

- (1) Requirements for "Law for Promotion of Effective Utilization of Resources"
 - (a) Recycle as much of this product as possible when finished with use.
 - (b) When recycling, often parts are sorted into steel scraps and electric parts, etc., and sold to scrap contractors. Mitsubishi recommends sorting the product and selling the members to appropriate contractors.

- (2) Requirements for "Law for Treatment of Waste and Cleaning"
 - (a) Mitsubishi recommends recycling and selling the product when no longer needed according to item (1) above. The user should make an effort to reduce waste in this manner.
 - (b) When disposing a product that cannot be resold, it shall be treated as a waste product.
 - (c) The treatment of industrial waste must be commissioned to a licensed industrial waste treatment contractor, and appropriate measures, including a manifest control, must be taken.
 - (d) Batteries correspond to "primary batteries", and must be disposed of according to local disposal laws.

Disposal



(Note) This symbol mark is for EU countries only.
This symbol mark is according to the directive 2006/66/EC Article 20 Information for end-users and Annex II.

Your MITSUBISHI ELECTRIC product is designed and manufactured with high quality materials and components which can be recycled and/or reused.

This symbol means that batteries and accumulators, at their end-of-life, should be disposed of separately from your household waste.

If a chemical symbol is printed beneath the symbol shown above, this chemical symbol means that the battery or accumulator contains a heavy metal at a certain concentration. This will be indicated as follows:

Hg: mercury (0,0005%), Cd: cadmium (0,002%), Pb: lead (0,004%)

In the European Union there are separate collection systems for used batteries and accumulators.

Please, dispose of batteries and accumulators correctly at your local community waste collection/recycling centre.

Please, help us to conserve the environment we live in!

Trademarks

MELDAS, MELSEC, EZSocket, EZMotion, iQ Platform, MELSOFT, GOT, CC-Link, CC-Link/LT and CC-Link IE are either trademarks or registered trademarks of Mitsubishi Electric Corporation in Japan and/or other countries.

Other company and product names that appear in this manual are trademarks or registered trademarks of the respective companies.

本製品の取扱いについて

(日本語 /Japanese)

本製品は工業用(クラス A)電磁環境適合機器です。販売者あるいは使用者はこの点に注意し、住商業環境以外での使用をお願いいたします。

Handling of our product

(English)

This is a class A product. In a domestic environment this product may cause radio interference in which case the user may be required to take adequate measures.

본 제품의 취급에 대해서

(한국어 /Korean)

이 기기는 업무용(A급) 전자파적합기기로서 판매자 또는 사용자는 이 점을 주의하시기 바라며 가정외의 지역에서 사용하는 것을 목적으로 합니다.

WARRANTY

Please confirm the following product warranty details before using MITSUBISHI CNC.

1. Warranty Period and Coverage

Should any fault or defect (hereafter called "failure") for which we are liable occur in this product during the warranty period, we shall provide repair services at no cost through the distributor from which the product was purchased or through a Mitsubishi Electric service provider. Note, however that this shall not apply if the customer was informed prior to purchase of the product that the product is not covered under warranty. Also note that we are not responsible for any on-site readjustment and/or trial run that may be required after a defective unit is replaced.

[Warranty Term]

The term of warranty for this product shall be twenty-four (24) months from the date of delivery of product to the end user, provided the product purchased from us in Japan is installed in Japan (but in no event longer than thirty (30) months, including the distribution time after shipment from Mitsubishi Electric or its distributor).

Note that, for the case where the product purchased from us in or outside Japan is exported and installed in any country other than where it was purchased; please refer to "2. Service in overseas countries" as will be explained.

[Limitations]

- (1) The customer is requested to conduct an initial failure diagnosis by him/herself, as a general rule. It can also be carried out by us or our service provider upon the customer's request and the actual cost will be charged.
- (2) This warranty applies only when the conditions, method, environment, etc., of use are in compliance with the terms and conditions and instructions that are set forth in the instruction manual, user's manual, and the caution label affixed to the product, etc.
- (3) Even during the term of warranty, repair costs shall be charged to the customer in the following cases:
 - (a) a failure caused by improper storage or handling, carelessness or negligence, etc., or a failure caused by the customer's hardware or software problem
 - (b) a failure caused by any alteration, etc., to the product made by the customer without Mitsubishi Electric's approval
 - (c) a failure which may be regarded as avoidable, if the customer's equipment in which this product is incorporated is equipped with a safety device required by applicable laws or has any function or structure considered to be indispensable in the light of common sense in the industry
 - (d) a failure which may be regarded as avoidable if consumable parts designated in the instruction manual, etc. are duly maintained and replaced
 - (e) any replacement of consumable parts (including a battery, relay and fuse)
 - (f) a failure caused by external factors such as inevitable accidents, including without limitation fire and abnormal fluctuation of voltage, and acts of God, including without limitation earthquake, lightning, and natural disasters
 - (g) a failure which is unforeseeable under technologies available at the time of shipment of this product from our company
 - (h) any other failures which we are not responsible for or which the customer acknowledges we are not responsible for

2. Service in Overseas Countries

If the customer installs the product purchased from us in his/her machine or equipment, and export it to any country other than where he/she bought it, the customer may sign a paid warranty contract with our local FA center.

This falls under the case where the product purchased from us in or outside Japan is exported and installed in any country other than where it was purchased.

For details please contact the distributor from which the customer purchased the product.

3. Exclusion of Loss in Opportunity and Secondary Loss from Warranty Liability

Regardless of the gratis warranty term, Mitsubishi shall not be liable for compensation to:

- (1) Damages caused by any cause found not to be the responsibility of Mitsubishi.
- (2) Loss in opportunity, lost profits incurred to the user by Failures of Mitsubishi products.
- (3) Special damages and secondary damages whether foreseeable or not, compensation for accidents, and compensation for damages to products other than Mitsubishi products.
- (4) Replacement by the user, maintenance of on-site equipment, start-up test run and other tasks.

4. Changes in Product Specifications

Specifications shown in our catalogs, manuals or technical documents are subject to change without notice.

5. Product Application

- (1) For the use of this product, its applications should be those that may not result in a serious damage even if any failure or malfunction occurs in the product, and a backup or fail-safe function should operate on an external system to the product when any failure or malfunction occurs.
- (2) Mitsubishi CNC is designed and manufactured solely for applications to machine tools to be used for industrial purposes. Do not use this product in any applications other than those specified above, especially those which are substantially influential on the public interest or which are expected to have significant influence on human lives or properties.

Contents

1 Introduction	1
1.1 Outline	2
1.1.1 Features	2
1.1.2 Caution	2
1.1.3 Replacement Model List	3
1.1.4 List of Encoder Compatibility	7
1.1.5 List of Peripheral Device Compatibility	7
1.1.6 Function Specifications List	8
1.2 Servo/Spindle Drive System Configuration	9
1.2.1 System Configuration	9
1.2.2 Servo Drive Unit Type	10
1.2.3 Spindle Drive Unit Type	12
1.2.4 Power Supply Unit Type	13
2 Specifications	15
2.1 Drive Unit	16
2.1.1 Installation Environment Conditions	16
2.1.2 Servo Drive Unit	16
2.1.3 Spindle Drive Unit	18
2.1.4 Power Supply Unit	19
2.1.5 AC Reactor	20
2.1.6 Unit Outline Drawing	21
2.1.7 Unit Outline Dimension Drawing	22
2.1.8 AC Reactor Outline Dimension Drawing	37
2.1.9 Explanation of Each Part	38
2.1.10 Setting DIP Switch	41
2.1.11 Setting the Rotary Switch	43
3 Characteristics	45
3.1 Drive Unit	46
3.1.1 Environmental Conditions	46
3.1.2 Heating Value	47
4 Dedicated Options	49
4.1 Drive Unit	50
4.1.1 Dynamic Brake Unit (MDS-B-DBU)	50
4.1.2 Dedicated Adapter for Main Circuit Power Supply (CNU01SC1NCV)	52
4.1.3 MC Extension Kit (MC-SET)	53
4.1.4 External Emergency Stop Conversion Cable	54
5 Troubleshooting	55
5.1 LED Display When Alarm or Warning Occurs	56
6 Specifications of Peripheral Devices	59
6.1 Selection of Wire	60
6.1.1 Example of Wires by Unit	60
Appendix 1 EMC Installation Guidelines	61
Appendix 1.1 Introduction	62
Appendix 1.2 EMC Instructions	62
Appendix 1.3 EMC Measures	63
Appendix 1.4 Measures for Panel Structure	63
Appendix 1.4.1 Measures for Control Panel Unit	63
Appendix 1.4.2 Measures for Door	64
Appendix 1.4.3 Measures for Operation Board Panel	64
Appendix 1.4.4 Shielding of the Power Supply Input Section	64
Appendix 1.5 Measures for Various Cables	65
Appendix 1.5.1 Measures for Wiring in Panel	65
Appendix 1.5.2 Measures for Shield Treatment	65
Appendix 1.5.3 Servo/Spindle Motor Power Cable	66
Appendix 1.5.4 Servo/Spindle Motor Encoder Cable	67

Appendix 1.6 EMC Countermeasure Parts 68
Appendix 1.6.1 Shield Clamp Fitting 68
Appendix 1.6.2 Ferrite Core 68
Appendix 1.6.3 Power Line Filter 70
Appendix 1.6.4 Surge Absorber 71

Outline for MDS-C1 Series Specifications Manual (BNP-C3040-E(ENG))

1 Introduction

- 1-1 Servo/spindle drive system configuration
 - 1-1-1 System configuration
 - 1-1-2 Unit outline type
- 1-2 Explanation of type
 - 1-2-1 Servomotor type
 - 1-2-2 Servo drive unit type
 - 1-2-3 Spindle motor type
 - 1-2-4 Spindle drive unit type
 - 1-2-5 Power supply unit type
 - 1-2-6 AC reactor type

2 Specifications

- 2-1 Servomotor
 - 2-1-1 Specifications list
 - 2-1-2 Torque characteristics
- 2-2 Spindle motor
 - 2-2-1 Specifications
 - 2-2-2 Output characteristics
- 2-3 Drive unit
 - 2-3-1 Installation environment conditions
 - 2-3-2 Servo drive unit
 - 2-3-3 Spindle drive unit
 - 2-3-4 Power supply unit
 - 2-3-5 AC reactor
 - 2-3-6 D/A output specifications for servo drive unit
 - 2-3-7 D/A output specifications for spindle drive unit
 - 2-3-8 Explanation of each part
- 2-4 Restrictions on servo control
 - 2-4-1 Restrictions of electronic gear setting value
 - 2-4-2 Restrictions on absolute position control

3 Characteristics

- 3-1 Servomotor
 - 3-1-1 Environmental conditions
 - 3-1-2 Quakeproof level
 - 3-1-3 Shaft characteristics
 - 3-1-4 Oil/water standards
 - 3-1-5 Magnetic brake
 - 3-1-6 Dynamic brake characteristics
- 3-2 Spindle motor
 - 3-2-1 Environmental conditions
 - 3-2-2 Shaft characteristics
- 3-3 Drive unit characteristics
 - 3-3-1 Environmental conditions
 - 3-3-2 Heating value
 - 3-3-3 Overload protection characteristics

4 Dedicated Options

- 4-1 Servo options
 - 4-1-1 Battery and terminator option (mandatory selection)

- 4-1-2 Dynamic brake unit (MDS-B-DBU) (mandatory selection for large capacity)
- 4-1-3 Ball screw side detector
- 4-1-4 Machine side detector
- 4-1-5 Detector conversion unit (MDS-B-HR)
- 4-1-6 Signal divider unit (MDS-B-SD)
- 4-2 Spindle option
 - 4-2-1 Magnetic sensor
 - 4-2-2 Spindle side detector (OSE-1024-3-15-68, OSE-1024-3-15-68-8)
 - 4-2-3 C-axis detector (OSE90K)
 - 4-2-4 C-axis detector (MBE90K)
 - 4-2-5 C-axis detector (MHE90K)
 - 4-2-6 Spindle side PLG (MXE128/180/256/512)
 - 4-2-7 Detector conversion unit (MDS-B-PJEX)
- 4-3 Cables and connectors
 - 4-3-1 Cable connection diagram
 - 4-3-2 List of cables and connectors

5 Peripheral Devices

- 5-1 Selection of wire
 - 5-1-1 Example of wires by unit
- 5-2 Selection the AC reactor, contactor and no-fuse breaker
 - 5-2-1 Standard selection
 - 5-2-2 Selection when a contactor is shared
- 5-3 Earth leakage breaker
- 5-4 Branch-circuit protection
 - 5-4-1 Circuit protector
 - 5-4-2 Fuse protection
- 5-5 Noise filter
- 5-6 Surge absorber
- 5-7 Speedometer and load meter
- 5-8 Cable for peripheral control
 - 5-8-1 Cable for external emergency stop
 - 5-8-2 Cable for servomotor magnetic brake

Appendix 1 Outline Dimension Drawings

- Appendix 1-1 Servomotor outline dimension drawings
 - Appendix 1-1-1 HC Series
 - Appendix 1-1-2 HA Series
- Appendix 1-2 Outline dimension drawings of spindle motor
 - Appendix 1-2-1 SJ Series
 - Appendix 1-2-2 SJ-V Series
 - Appendix 1-2-3 SJ-VS Series
 - Appendix 1-2-4 SJ-PMF Series (IPM motor)
- Appendix 1-3 Unit outline dimension drawings
 - Appendix 1-3-1 Servo/spindle drive unit
 - Appendix 1-3-2 Power supply unit
 - Appendix 1-3-3 AC reactor

Appendix 2 Cable and Connector Specifications

- Appendix 2-1 Selection of cable
 - Appendix 2-1-1 Cable wire and assembly
 - Appendix 2-1-2 Flexible conduits
- Appendix 2-2 Cable connection diagram
- Appendix 2-3 Connector outline dimension drawings

Appendix 3 Selection

- Appendix 3-1 Selecting the servomotor series
 - Appendix 3-1-1 Motor series characteristics
 - Appendix 3-1-2 Servomotor precision
- Appendix 3-2 Selection of servomotor capacity
 - Appendix 3-2-1 Load inertia ratio
 - Appendix 3-2-2 Short time characteristics
 - Appendix 3-2-3 Continuous characteristics
- Appendix 3-3 Example of servo selection
 - Appendix 3-3-1 Motor selection calculation
 - Appendix 3-3-2 Servo selection results
 - Appendix 3-3-3 Motor shaft conversion load torque
 - Appendix 3-3-4 Expressions for load inertia calculation
- Appendix 3-4 Selecting the power supply
 - Appendix 3-4-1 Selecting according to the continuous rated capacity
 - Appendix 3-4-2 Selection with maximum momentary capacity
 - Appendix 3-4-3 Selection example

Appendix 4 Explanation of Large Capacity Spindle Unit Specifications

- Appendix 4-1 Explanation of large capacity spindle unit specifications
 - Appendix 4-1-1 Outline
 - Appendix 4-1-2 List of units
 - Appendix 4-1-3 Selection of AC reactor (B-AL), contactor and NFB
 - Appendix 4-1-4 Outline dimension drawings
 - Appendix 4-1-5 Panel cut dimension drawing
 - Appendix 4-1-6 Heating value
 - Appendix 4-1-7 Selecting the power capacity
 - Appendix 4-1-8 Selecting the wire size
 - Appendix 4-1-9 Drive unit connection screw size
 - Appendix 4-1-10 Connecting each unit
 - Appendix 4-1-11 Restrictions
 - Appendix 4-1-12 Parameters
 - Appendix 4-1-13 Precautions

Appendix 5 Transportation Restrictions for Lithium Batteries

- Appendix 5-1 Transportation restrictions for lithium batteries
 - Appendix 5-1-1 Restriction for packing
 - Appendix 5-1-2 Issuing domestic law of the United State for primary lithium battery transportation

Appendix 6 Compliance to EU EC Directives

- Appendix 6-1 Compliance to EC Directives
 - Appendix 6-1-1 European EC Directives
 - Appendix 6-1-2 Cautions for EC Directive compliance

Appendix 7 EMC Installation Guidelines

- Appendix 7-1 Introduction
- Appendix 7-2 EMC instructions
- Appendix 7-3 EMC measures

- Appendix 7-4 Measures for panel structure
 - Appendix 7-4-1 Measures for control panel unit
 - Appendix 7-4-2 Measures for door
 - Appendix 7-4-3 Measures for operation board panel
 - Appendix 7-4-4 Shielding of the power supply input section
- Appendix 7-5 Measures for various cables
 - Appendix 7-5-1 Measures for wiring in panel
 - Appendix 7-5-2 Measures for shield treatment
 - Appendix 7-5-3 Servomotor power cable
 - Appendix 7-5-4 Servomotor feedback cable
 - Appendix 7-5-5 Spindle motor power cable
 - Appendix 7-5-6 Spindle motor feedback cable
- Appendix 7-6 EMC countermeasure parts
 - Appendix 7-6-1 Shield clamp fitting
 - Appendix 7-6-2 Ferrite core
 - Appendix 7-6-3 Power line filter
 - Appendix 7-6-4 Surge protector

Appendix 8 EC Declaration of conformity

- Appendix 8-1 Compliance to EC Directives
 - Appendix 8-1-1 Low voltage equipment
 - Appendix 8-1-2 Electromagnetic compatibility

Appendix 9 Instruction Manual for Compliance with UL/c-UL Standard

- Appendix 9 Instruction Manual for Compliance with UL/c-UL Standard

Appendix 10 Compliance with China Compulsory Product Certification (CCC Certification) System

- Appendix 10-1 Outline of China Compulsory Product Certification System
- Appendix 10-2 First Catalogue of Products subject to Compulsory Product Certification
- Appendix 10-3 Precautions for Shipping Products
- Appendix 10-4 Application for Exemption
- Appendix 10-5 Mitsubishi NC Product Subject to/Not Subject to CCC Certification

Outline for MDS-C1 Series Instruction Manual (BNP-B2365-B(ENG))

1 Installation

- 1-1 Installation of servomotor
 - 1-1-1 Environmental conditions
 - 1-1-2 Quakeproof level
 - 1-1-3 Cautions for mounting load (prevention of impact on shaft)
 - 1-1-4 Installation direction
 - 1-1-5 Shaft characteristics
 - 1-1-6 Oil/water standards
 - 1-1-7 Cable stress
- 1-2 Installation of spindle motor
 - 1-2-1 Environmental conditions
 - 1-2-2 Shaft characteristics
- 1-3 Installation of the control unit
 - 1-3-1 Environmental conditions
 - 1-3-2 Installation direction and clearance
 - 1-3-3 Prevention of entering of foreign matter
 - 1-3-4 Panel installation hole work drawings (Panel cut drawings)
 - 1-3-5 Heating value
 - 1-3-6 Heat radiation countermeasures
- 1-4 Installing the spindle detector
 - 1-4-1 Magnetic sensor
 - 1-4-2 Spindle end detector
 - 1-4-3 Spindle end PLG
 - 1-5 Noise measures

2 Wiring and Connection

- 2-1 Part system connection diagram
- 2-2 Main circuit terminal block/control circuit connector
 - 2-2-1 Names and applications of main circuit terminal block signals and control circuit connectors
 - 2-2-2 Connector pin assignment
- 2-3 NC and drive unit connection
- 2-4 Motor and detector connection
 - 2-4-1 Connecting the servomotor
 - 2-4-2 Connecting the full-closed loop system
 - 2-4-3 Connecting the synchronous control system
 - 2-4-4 Connection of the spindle motor
- 2-5 Connection of power supply
 - 2-5-1 Power supply input connection
 - 2-5-2 Connecting the grounding cable
 - 2-5-3 Main circuit control
- 2-6 Wiring of the motor brake
 - 2-6-1 Wiring of the motor magnetic brake
 - 2-6-2 Dynamic brake unit wiring
- 2-7 Peripheral control wiring
 - 2-7-1 Input/output circuit wiring
 - 2-7-2 Spindle coil changeover
 - 2-7-3 Wiring of an external emergency stop

3 Initial setup

- 3-1 Initial setup
 - 3-1-1 Setting the rotary switch

- 3-1-2 Transition of LED display after power is turned ON
- 3-1-3 Servo standard specifications and high-gain specifications
- 3-2 Setting the initial parameters for the servo drive unit (High-gain specifications)
 - 3-2-1 Setting the standard parameters
 - 3-2-2 List of standard parameters for each servomotor
 - 3-2-3 Servo parameter list
- 3-3 Setting the initial parameters for the servo drive unit (Standard specifications)
 - 3-3-1 Setting the standard parameters
 - 3-3-2 List of standard parameters for each servomotor
 - 3-3-3 Servo parameter list
- 3-4 Restrictions on servo control
 - 3-4-1 Restrictions of electronic gear setting value
 - 3-4-2 Restrictions on absolute position control
- 3-5 Setting the initial parameters for the spindle drive unit
 - 3-5-1 Spindle specification parameters
 - 3-5-2 List of spindle parameters
- 3-6 Initial adjustment of the spindle PLG
 - 3-6-1 Adjusting the PLG installation
 - 3-6-2 Z phase automatic adjustment
 - 3-6-3 Motor end PLG automatic adjustment
 - 3-6-4 Spindle end PLG automatic adjustment

4 Servo Adjustment

- 4-1 D/A output specifications for servo drive unit
 - 4-1-1 D/A output specifications
 - 4-1-2 Output data settings
 - 4-1-3 Setting the output magnification
- 4-2 Gain adjustment
 - 4-2-1 Current loop gain
 - 4-2-2 Speed loop gain
 - 4-2-3 Position loop gain
- 4-3 Characteristics improvement
 - 4-3-1 Optimal adjustment of cycle time
 - 4-3-2 Vibration suppression measures
 - 4-3-3 Improving the cutting surface precision
 - 4-3-4 Improvement of characteristics during acceleration/deceleration
 - 4-3-5 Improvement of protrusion at quadrant changeover
 - 4-3-6 Improvement of overshooting
 - 4-3-7 Improvement of the interpolation control path
- 4-4 Adjustment during full closed loop control
 - 4-4-1 Outline
 - 4-4-2 Speed loop delay compensation
 - 4-4-3 Dual feedback control (Optional function)
- 4-5 Settings for emergency stop
 - 4-5-1 Deceleration control
 - 4-5-2 Vertical axis drop prevention control
- 4-6 Protective functions
 - 4-6-1 Overload detection
 - 4-6-2 Excessive error detection
 - 4-6-3 Collision detection

5 Spindle Adjustment

- 5-1 D/A output specifications for spindle drive unit
 - 5-1-1 D/A output specifications
 - 5-1-2 Setting the output data
 - 5-1-3 Setting the output magnification
- 5-2 Spindle control signal
 - 5-2-1 Spindle control input (NC to SP)
 - 5-2-2 Spindle control output (SP to NC)
- 5-3 Adjustment procedures for each control
 - 5-3-1 Basic adjustments
 - 5-3-2 Adjusting the acceleration/deceleration operation
 - 5-3-3 Adjusting the orientation control
 - 5-3-4 Adjusting the synchronous tap control
 - 5-3-5 Adjusting the C-axis control
 - 5-3-6 Adjusting the spindle synchronous control

6 Troubleshooting

- 6-1 Points of caution and confirmation
 - 6-1-1 LED display when alarm or warning occurs
- 6-2 Protective functions list of units
 - 6-2-1 List of alarms
 - 6-2-2 List of warnings
- 6-3 Troubleshooting
 - 6-3-1 Troubleshooting at power ON
 - 6-3-2 Troubleshooting for each alarm No
 - 6-3-3 Troubleshooting for each warning No
 - 6-3-4 Parameter numbers during initial parameter error
 - 6-3-5 Troubleshooting the spindle system when there is no alarm or warning

7 Maintenance

- 7-1 Inspections
- 7-2 Service parts
- 7-3 Adding and replacing units and parts
 - 7-3-1 Replacing the drive unit
 - 7-3-2 Replacing the unit fan

Appendix 1 Cable and Connector Specifications

- Appendix 1-1 Selection of cable
 - Appendix 1-1-1 Cable wire and assembly
 - Appendix 1-1-2 Flexible conduits
- Appendix 1-2 Cable connection diagram
- Appendix 1-3 Connector outline dimension drawings

Appendix 2 Compliance to EC Directives

- Appendix 2-1 Compliance to EC Directives
 - Appendix 2-1-1 European EC Directives
 - Appendix 2-1-2 Cautions for EC Directive compliance

Appendix 3 EMC Installation Guidelines

- Appendix 3-1 Introduction
- Appendix 3-2 EMC instructions
- Appendix 3-3 EMC measures
- Appendix 3-4 Measures for panel structure
 - Appendix 3-4-1 Measures for control panel unit
 - Appendix 3-4-2 Measures for door

Appendix 3-4-3 Measures for operation board panel

Appendix 3-4-4 Shielding of the power supply input section

Appendix 3-5 Measures for various cables

Appendix 3-5-1 Measures for wiring in panel

Appendix 3-5-2 Measures for shield treatment

Appendix 3-5-3 Servo/spindle motor power cable

Appendix 3-5-4 Servo motor feedback cable

Appendix 3-5-5 Spindle motor feedback cable

Appendix 3-6 EMC countermeasure parts

Appendix 3-6-1 Shield clamp fitting

Appendix 3-6-2 Ferrite core

Appendix 3-6-3 Power line filter

Appendix 3-6-4 Surge protector

Appendix 4 Servo/spindle drive unit categories based on higher harmonic suppression countermeasure guidelines

Appendix 4-1 Servo/spindle drive unit circuit categories based on higher harmonic suppression countermeasure guidelines

Outline for MDS-CH Series Specifications Manual (BNP-C3016-F(ENG))

1 Preface

- 1-1 Inspection at purchase
 - 1-1-1 Package contents
 - 1-1-2 Rating nameplate
 - 1-1-3 Power supply unit model
 - 1-1-4 Servo drive unit model
 - 1-1-5 Spindle drive unit model
- 1-2 Explanation of each part
 - 1-2-1 Explanation of each power supply unit part
 - 1-2-2 Explanation of each servo drive unit part
 - 1-2-3 Explanation of each spindle drive unit part

2 Wiring and Connection

- 2-1 Part system connection diagram
- 2-2 Main circuit terminal block/control circuit connector
 - 2-2-1 Connector pin assignment
 - 2-2-2 Names and applications of main circuit terminal block signals and control circuit connectors
 - 2-2-3 How to use the control circuit terminal block (MDS-CH-SP-750)
- 2-3 NC and drive unit connection
- 2-4 Motor and detector connection
 - 2-4-1 Connection of HC-H Series
 - 2-4-2 Connection of the spindle motor
 - 2-4-3 Connection of the linear servomotor LM-NP Series
- 2-5 Connection of power supply
 - 2-5-1 Standard connection
 - 2-5-2 DC connection bar
 - 2-5-3 Two-part system control of power supply unit
 - 2-5-4 Using multiple power supply units
- 2-6 Connection of AC reactor
 - 2-6-1 Features of the AC reactor
 - 2-6-2 Wiring of AC reactor
- 2-7 Wiring of contactors
 - 2-7-1 Contactor power ON sequences
 - 2-7-2 Contactor shutoff sequences
 - 2-7-3 Contactor control signal (MC1) output circuit
- 2-8 Wiring of the motor brake
 - 2-8-1 Motor brake release sequence
 - 2-8-2 Control during the servo OFF command
 - 2-8-3 Operation sequences when an emergency stop occurs
 - 2-8-4 Motor brake control connector (CN20) output circuit
- 2-9 Wiring of an external emergency stop
 - 2-9-1 External emergency stop setting
 - 2-9-2 Operation sequences of CN23 external emergency stop function
 - 2-9-3 Example of emergency stop circuit
- 2-10 Connecting the Grounding Cable

- 2-10-1 Connecting the Frame Ground (FG)
- 2-10-2 Grounding cable size

3 Installation

- 3-1 Installation of the units
 - 3-1-1 Environmental conditions
 - 3-1-2 Installation direction and clearance
 - 3-1-3 Prevention of entering of foreign matter
 - 3-1-4 Panel installation hole work drawings (Panel cut drawings)
 - 3-1-5 Heating value
 - 3-1-6 Heat radiation countermeasures
- 3-2 Installation of servomotor/spindle motor
 - 3-2-1 Environmental conditions
 - 3-2-2 Cautions for mounting load (prevention of impact on shaft)
 - 3-2-3 Installation direction
 - 3-2-4 Tolerable load of axis
 - 3-2-5 Oil and waterproofing measures
 - 3-2-6 Cable stress
- 3-3 Installing the linear servomotor
 - 3-3-1 Installation environment
 - 3-3-2 Installing the linear servomotor
 - 3-3-3 Cooling the linear servomotor
- 3-4 Noise measures

4 Setup

- 4-1 Initial setup
 - 4-1-1 Setting the rotary switch
 - 4-1-2 Transition of LED display after power is turned ON
- 4-2 Servo drive unit initial parameter settings
 - 4-2-1 List of servo parameters
 - 4-2-2 Limitations to electronic gear setting value
 - 4-2-3 Setting excessive detection error width
 - 4-2-4 Setting motor and detector model
 - 4-2-5 Setting servo specifications
 - 4-2-6 Initial setup of the linear servo system
 - 4-2-7 Standard parameter list according to motor
- 4-3 Spindle drive unit initial parameter settings
 - 4-3-1 List of spindle parameters
 - 4-3-2 Details of bit-corresponding parameters
 - 4-3-3 Setting spindle drive unit and motor model
 - 4-3-4 Spindle specification parameters screen
 - 4-3-5 Spindle control signals

5 Adjustment

- 5-1 Servo adjustment data output function (D/A output)
 - 5-1-1 D/A output specifications
 - 5-1-2 Setting the output data
 - 5-1-3 Setting the output magnification
- 5-2 Gain adjustment
 - 5-2-1 Current loop gain
 - 5-2-2 Speed loop gain
 - 5-2-3 Position loop gain
- 5-3 Characteristics improvement
 - 5-3-1 Optimal adjustment of cycle time
 - 5-3-2 Vibration suppression measures
 - 5-3-3 Improving the cutting surface precision

- 5-3-4 Improvement of protrusion at quadrant changeover
- 5-3-5 Improvement of overshooting
- 5-3-6 Improvement of characteristics during acceleration/deceleration
- 5-4 Settings for emergency stop
 - 5-4-1 Vertical axis drop prevention control
 - 5-4-2 Deceleration control
 - 5-4-3 Dynamic braking stop
- 5-5 Collision detection function
- 5-6 Spindle adjustment data output function (D/A output)
 - 5-6-1 D/A output specifications
 - 5-6-2 Parameter settings
 - 5-6-3 Output data settings
 - 5-6-4 Setting the output magnification
- 5-7 Spindle adjustment
 - 5-7-1 Items to check during trial operation
 - 5-7-2 Adjusting the spindle rotation speed
 - 5-7-3 Adjusting the acceleration/deceleration
 - 5-7-4 Adjusting the orientation
 - 5-7-5 Synchronous tap adjustment
 - 5-7-6 Z-phase (magnetic) automatic adjustment (Only when using IPM spindle motor)
 - 5-7-7 PLG automatic adjustment
 - 5-7-8 Calculating the theoretical acceleration/deceleration
- 5-8 Spindle specifications
 - 5-8-1 Spindle coil changeover

6 Dedicated Options

- 6-1 Dynamic brake unit
 - 6-1-2 Outline dimension drawings of dynamic brake unit
- 6-2 Battery option
 - 6-2-1 Battery unit
 - 6-2-2 Connection
 - 6-2-3 Dedicated battery cable drawing
- 6-3 Cables and connectors
 - 6-3-1 Cable option list
 - 6-3-2 Connector outline dimension drawings
 - 6-3-3 Flexible conduits
 - 6-3-4 Cable wire and assembly
 - 6-3-5 Option cable connection diagram
 - 6-3-6 Main circuit cable connection drawing
- 6-4 Scale I/F unit
 - 6-4-1 Outline
 - 6-4-2 Model configuration
 - 6-4-3 List of specifications
 - 6-4-4 Unit outline dimension drawing
 - 6-4-5 Description of connector
 - 6-4-6 Example of detector conversion unit connection
 - 6-4-7 Cables
- 6-5 Magnetic pole detection unit
 - 6-5-1 Outline
 - 6-5-2 Model configuration
 - 6-5-3 List of specifications
 - 6-5-4 Outline dimensions
 - 6-5-5 Assignment of connector pins

- 6-5-6 Installing onto the linear servomotor
- 6-6 Detectors
 - 6-6-1 List of detector specifications
 - 6-6-2 Outline dimension drawings
 - 6-6-3 Cable connection diagram
 - 6-6-4 Maintenance
- 6-7 Spindle option specification parts
 - 6-7-1 Magnetic sensor orientation (one-point orientation)
 - 6-7-2 Multi-point orientation using encoder (4096-point orientation)
 - 6-7-3 Multi-point orientation using motor built-in encoder (4096-point orientation)
 - 6-7-4 Contour control (C axis control) encoder
 - 6-7-5 Integrated rotary encoder (Special order part)
- 6-8 AC reactor
 - 6-8-1 Combination with power supply unit
 - 6-8-2 Outline dimension drawings

7 Peripheral Devices

- 7-1 Selection of wire
 - 7-1-1 Example of wires by unit
- 7-2 Selection of main circuit breaker and contactor
 - 7-2-1 Selection of earth leakage breaker
 - 7-2-2 Selection of no-fuse breaker
 - 7-2-3 Selection of contactor
- 7-3 Control circuit related
 - 7-3-1 Circuit protector
 - 7-3-2 Fuse protection
 - 7-3-3 Relays
 - 7-3-4 Surge absorber

8 Troubleshooting

- 8-1 Points of caution and confirmation
- 8-2 Troubleshooting at start up
- 8-3 Protective functions list of units
 - 8-3-1 List of alarms
 - 8-3-2 List of warnings
 - 8-3-3 Protection functions and resetting methods
 - 8-3-4 Parameter numbers during initial parameter error
 - 8-3-5 Troubleshooting
- 8-4 Spindle system troubleshooting
 - 8-4-1 Introduction
 - 8-4-2 First step
 - 8-4-3 Second step
 - 8-4-4 When there is no alarm or warning

9 Characteristics

- 9-1 Overload protection characteristics
 - 9-1-1 Servomotor (HC-H series)
 - 9-1-2 Linear servomotor (LM-NP Series)
- 9-2 Duty characteristics
- 9-3 Magnetic brake characteristics
- 9-4 Dynamic brake characteristics
 - 9-4-1 Deceleration torque
 - 9-4-2 Determining the coasting amount with emergency stop
- 9-5 Vibration class

10 Specifications

- 10-1 Power supply unit/drive unit
 - 10-1-1 Installation environment conditions
 - 10-1-2 Servo drive unit
 - 10-1-3 Spindle drive unit
 - 10-1-4 Power supply unit
 - 10-1-5 Outline dimension drawings
 - 10-1-6 Terminal layout
 - 10-1-7 The combination of servo drive unit and a motor
- 10-2 Servomotor
 - 10-2-1 Specifications list
 - 10-2-2 Torque characteristics
 - 10-2-3 Model configuration
 - 10-2-4 Outline dimension drawings
- 10-3 Linear servomotor
 - 10-3-1 List of specifications
 - 10-3-2 Outline dimension drawings

11 Selection

- 11-1 Selection of servomotor
 - 11-1-1 Servomotor
 - 11-1-2 Regeneration methods
 - 11-1-3 Motor series characteristics
 - 11-1-4 Servomotor precision
 - 11-1-5 Selection of servomotor capacity
 - 11-1-6 Example of servo selection
 - 11-1-7 Motor shaft conversion load torque
 - 11-1-8 Expressions for load inertia calculation
 - 11-1-9 Other precautions
- 11-2 Selection of linear servomotor
 - 11-2-1 Maximum feedrate
 - 11-2-2 Maximum thrust
 - 11-2-3 Continuous thrust
- 11-3 Selection of the power supply unit
 - 11-3-1 Selection of the power supply unit capacity
 - 11-3-2 Selection with continuous rated capacity
 - 11-3-3 Selection with maximum momentary rated capacity

12 Inspection

- 12-1 Inspections
- 12-2 Service parts
- 12-3 Daily inspections
 - 12-3-1 Maintenance tools
 - 12-3-2 Inspection positions
- 12-4 Replacement methods of units and parts
 - 12-4-1 Drive unit and power supply unit replacements
 - 12-4-2 Battery unit replacements
 - 12-4-3 Cooling fan replacements

Appendix 1 Compliance to EC Directives

1. European EC Directives
2. Cautions for EC Directive compliance

Appendix 2 EMC Installation Guidelines

1. Introduction
2. EMC Instructions

3. EMC Measures
4. Measures for panel structure
 - 4.1 Measures for control box unit
 - 4.2 Measures for door
 - 4.3 Measures for operation board panel
 - 4.4 Shielding of the power supply input section
5. Measures for various cables
 - 5.1 Measures for wiring in box
 - 5.2 Measures for shield treatment
 - 5.3 Servomotor power cable
 - 5.4 Servomotor feedback cable
 - 5.5 Spindle motor power cable
 - 5.6 Cable between control box and operation board panel
6. EMC Countermeasure Parts
 - 6.1 Shield clamp fitting
 - 6.2 Ferrite core
 - 6.3 Power line filter
 - 6.4 Surge protector

Appendix 3 EC Declaration of conformity

1. Low voltage equipment
2. Electromagnetic compatibility

Appendix 4 Instruction Manual for Compliance with UL/c-UL Standard

1. UL/c-UL listed products
2. Operation surrounding air ambient temperature
3. Notes for AC servo/spindle system
 - 3.1 General Precaution
 - 3.2 Installation
 - 3.3 Short-circuit ratings
 - 3.5 Field Wiring Reference Table for Input and Output
 - 3.6 Motor Over Load Protection
 - 3.7 Flange of servomotor
 - 3.8 Spindle Drive / Motor Combinations
4. AC Servo/Spindle System Connection

Appendix 5 Higher Harmonic Suppression Measure Guidelines

1. Calculating the equivalent capacity of the higher harmonic generator
 - 1.1 Calculating the total equivalent capacity (Step 1)
 - 1.2 Calculating the higher harmonic current flow (Step 2)

Appendix 6 Transportation Restrictions for Lithium Batteries

- Appendix 6-1 Transportation restrictions for lithium batteries
 - Appendix 6-1-1 Restriction for packing
 - Appendix 6-1-2 Issuing domestic law of the United State for primary lithium battery transportation

Appendix 7 Compliance with China Compulsory Product Certification (CCC Certification) System

Appendix 7-1 Outline of China Compulsory Product Certification System

Appendix 7-2 First Catalogue of Products subject to Compulsory Product Certification

Appendix 7-3 Precautions for Shipping Products

Appendix 7-4 Application for Exemption

Appendix 7-5 Mitsubishi NC Product Subject to/Not Subject to CCC Certification



Introduction

1.1 Outline

MDS-C1-N Series is the drive unit for NC system that has been developed as a substitute product for MDS-A/B/C1 Series.

1.1.1 Features

- (1) **Integration**
MDS-A/B/C1 Series were integrated into MDS-C1-N Series.
- (2) **Compatibility**
The main wiring, encoder and function specifications are compatible with MDS-A/B/C1 Series. (Some parts are not compatible.)
- (3) **Supporting OHE/OHA encoder (the motor end)**
OHE/OHA encoder (the motor end) which was not supported by MDS-C1 Series is available.

1.1.2 Caution

- (1) **Selection**
The selection methods are the same as the current MDS-A/B/C1 Series.
- (2) **Unsupported function**
Select the current model to drive a linear or direct-drive motor, because these motors are not supported by MDS-C1-N Series.
- (3) **Incompatible model**

Model	Function
MDS-B-V14L/V24L	High gain mode (For linear)

1.1.3 Replacement Model List

(1) Servo drive unit

MDS-C1- □ -N Series	MDS-C1 Series	MDS-B Series	MDS-A Series
MDS-C1-V1-01-N/NA	MDS-C1-V1-01	MDS-B-V1-01	MDS-A-V1-01
MDS-C1-V1-03-N/NA	MDS-C1-V1-03	MDS-B-V1-03	MDS-A-V1-03
MDS-C1-V1-05-N/NA	MDS-C1-V1-05	MDS-B-V1-05	MDS-A-V1-05
MDS-C1-V1-10-N/NA	MDS-C1-V1-10	MDS-B-V1-10	MDS-A-V1-10
	-	MDS-B-V1-10F	-
MDS-C1-V1-20-N/NA	MDS-C1-V1-20	MDS-B-V1-20	MDS-A-V1-20
MDS-C1-V1-35-N/NA	MDS-C1-V1-35	MDS-B-V1-35	MDS-A-V1-35
MDS-C1-V1-45-N/NA	MDS-C1-V1-45	MDS-B-V1-45	MDS-A-V1-45
MDS-C1-V1-45S-N/NA	MDS-C1-V1-45S	-	-
MDS-C1-V1-70-N/NA	MDS-C1-V1-70	MDS-B-V1-70	MDS-A-V1-70
MDS-C1-V1-70S-N/NA	MDS-C1-V1-70S	-	-
MDS-C1-V1-90-N/NA	MDS-C1-V1-90	MDS-B-V1-90	MDS-A-V1-90
MDS-C1-V1-110-N/NA	MDS-C1-V1-110	MDS-B-V1-110	-
MDS-C1-V1-150-N/NA	MDS-C1-V1-150	MDS-B-V1-150	-
MDS-C1-V2-0101-N/NA	MDS-C1-V2-0101	MDS-B-V2-0101	MDS-A-V2-0101
MDS-C1-V2-0301-N/NA	MDS-C1-V2-0301	MDS-B-V2-0301	MDS-A-V2-0301
MDS-C1-V2-0303-N/NA	MDS-C1-V2-0303	MDS-B-V2-0303	MDS-A-V2-0303
MDS-C1-V2-0501-N/NA	MDS-C1-V2-0501	MDS-B-V2-0501	MDS-A-V2-0501
MDS-C1-V2-0503-N/NA	MDS-C1-V2-0503	MDS-B-V2-0503	MDS-A-V2-0503
MDS-C1-V2-0505-N/NA	MDS-C1-V2-0505	MDS-B-V2-0505	MDS-A-V2-0505
MDS-C1-V2-1003-N/NA	MDS-C1-V2-1003	MDS-B-V2-1003	-
MDS-C1-V2-1005-N/NA	MDS-C1-V2-1005	MDS-B-V2-1005	MDS-A-V2-1005
MDS-C1-V2-1010-N/NA	-	MDS-B-V2-1005F	-
	MDS-C1-V2-1010	MDS-B-V2-1010	MDS-A-V2-1010
	-	MDS-B-V2-1010F	-
MDS-C1-V2-2003-N/NA	MDS-C1-V2-2003	-	-
MDS-C1-V2-2010-N/NA	MDS-C1-V2-2010	MDS-B-V2-2010	MDS-A-V2-2010
MDS-C1-V2-2020-N/NA	MDS-C1-V2-2020	MDS-B-V2-2020	MDS-A-V2-2020
MDS-C1-V2-3510-N/NA	MDS-C1-V2-3510	MDS-B-V2-3510	MDS-A-V2-3510
MDS-C1-V2-3510S-N/NA	MDS-C1-V2-3510S	-	-
MDS-C1-V2-3520-N/NA	MDS-C1-V2-3520	MDS-B-V2-3520	MDS-A-V2-3520
MDS-C1-V2-3520S-N/NA	MDS-C1-V2-3520S	-	-
MDS-C1-V2-3535-N/NA	MDS-C1-V2-3535	MDS-B-V2-3535	MDS-A-V2-3535
MDS-C1-V2-4520-N/NA	MDS-C1-V2-4520	MDS-B-V2-4520	-
MDS-C1-V2-4535-N/NA	MDS-C1-V2-4535	MDS-B-V2-4535	-
MDS-C1-V2-4545-N/NA	MDS-C1-V2-4545	-	-
MDS-C1-V2-4545S-N/NA	MDS-C1-V2-4545S	-	-
MDS-C1-V2-7035-N/NA	MDS-C1-V2-7035	-	-
MDS-C1-V2-7045-N/NA	MDS-C1-V2-7045	-	-
MDS-C1-V2-7070-N/NA	MDS-C1-V2-7070	-	-
MDS-C1-V2-7070S-N/NA	MDS-C1-V2-7070S	-	-
MDS-C1-V2-9090S-N/NA	MDS-C1-V2-9090S	-	-

(2) Spindle drive unit

MDS-C1- □ -N Series	MDS-C1 Series	MDS-B Series	MDS-A Series
MDS-C1-SP-04-N/NA	MDS-C1-SP-04	MDS-B-SP-04	MDS-A-SP-04
	MDS-C1-SPH-04	MDS-B-SPH-04	MDS-A-SPH-04
	MDS-C1-SPX-04	-	-
	MDS-C1-SPHX-04	-	-
MDS-C1-SP-075-N/NA	MDS-C1-SP-075	MDS-B-SP-075	MDS-A-SP-075
	MDS-C1-SPH-075	MDS-B-SPH-075	MDS-A-SPH-075
	MDS-C1-SPX-075	-	-
	MDS-C1-SPHX-075	-	-
MDS-C1-SP-15-N/NA	MDS-C1-SP-15	MDS-B-SP-15	MDS-A-SP-15
	MDS-C1-SPH-15	MDS-B-SPH-15	MDS-A-SPH-15
	MDS-C1-SPX-15	MDS-B-SPX-15	-
	MDS-C1-SPHX-15	-	-
MDS-C1-SP-22-N/NA	MDS-C1-SP-22	MDS-B-SP-22	MDS-A-SP-22
	MDS-C1-SPH-22	MDS-B-SPH-22	MDS-A-SPH-22
	MDS-C1-SPX-22	MDS-B-SPX-22	-
	MDS-C1-SPHX-22	-	-
MDS-C1-SP-37-N/NA	MDS-C1-SP-37	MDS-B-SP-37	MDS-A-SP-37
	MDS-C1-SPH-37	MDS-B-SPH-37	MDS-A-SPH-37
	MDS-C1-SPX-37	MDS-B-SPX-37	-
	MDS-C1-SPHX-37	-	-
MDS-C1-SP-55-N/NA	MDS-C1-SP-55	MDS-B-SP-55	MDS-A-SP-55
	MDS-C1-SPH-55	MDS-B-SPH-55	MDS-A-SPH-55
	MDS-C1-SPX-55	-	-
	MDS-C1-SPHX-55	MDS-B-SPHX-55	-
MDS-C1-SP-75-N/NA	MDS-C1-SP-75	MDS-B-SP-75	MDS-A-SP-75
	MDS-C1-SPH-75	MDS-B-SPH-75	MDS-A-SPH-75
	MDS-C1-SPX-75	MDS-B-SPX-75	-
	MDS-C1-SPHX-75	-	-
MDS-C1-SP-110-N/NA	MDS-C1-SP-110	MDS-B-SP-110	MDS-A-SP-110
	MDS-C1-SPH-110	MDS-B-SPH-110	MDS-A-SPH-110
	MDS-C1-SPM-110	MDS-B-SPM-110	-
	MDS-C1-SPX-110	-	-
	MDS-C1-SPHX-110	-	-
MDS-C1-SP-150S-N/NA	MDS-C1-SP-150S	-	-
	MDS-C1-SPH-150S	-	-
	MDS-C1-SPX-150S	-	-
MDS-C1-SP-150-N/NA	MDS-C1-SP-150	MDS-B-SP-150	MDS-A-SP-150
	MDS-C1-SPH-150	MDS-B-SPH-150	MDS-A-SPH-150
	MDS-C1-SPM-150	MDS-B-SPM-150	-
	MDS-C1-SPX-150	-	-
	MDS-C1-SPHX-150	-	-
MDS-C1-SP-150-N/NA	MDS-C1-SP-150	MDS-B-SP-150	MDS-A-SP-150
	MDS-C1-SPH-150	MDS-B-SPH-150	MDS-A-SPH-150
	MDS-C1-SPM-150	MDS-B-SPM-150	-
	MDS-C1-SPX-150	-	-
	MDS-C1-SPHX-150	-	-
MDS-C1-SP-185-N/NA	MDS-C1-SP-185	MDS-B-SP-185	MDS-A-SP-185
	MDS-C1-SPH-185	MDS-B-SPH-185	MDS-A-SPH-185
	MDS-C1-SPM-185	MDS-B-SPM-185	-
	MDS-C1-SPX-185	MDS-B-SPX-185	-
	MDS-C1-SPHX-185	-	-

MDS-C1- □ -N Series	MDS-C1 Series	MDS-B Series	MDS-A Series
MDS-C1-SP-220-N/NA	MDS-C1-SP-220	MDS-B-SP-220	MDS-A-SP-220
	MDS-C1-SPH-220	MDS-B-SPH-220	MDS-A-SPH-220
	MDS-C1-SPM-220	-	-
	MDS-C1-SPX-220	MDS-B-SPX-220	-
	MDS-C1-SPHX-220	-	-
MDS-C1-SP-260-N/NA	MDS-C1-SP-260	MDS-B-SP-260	MDS-A-SP-260
	MDS-C1-SPH-260	MDS-B-SPH-260	MDS-A-SPH-260
	MDS-C1-SPM-260	-	-
	MDS-C1-SPX-260	MDS-B-SPX-260	-
	MDS-C1-SPHX-260	-	-
MDS-C1-SP-260U-N/NA	MDS-C1-SP-260U	-	-
	MDS-C1-SPH-260U	-	-
MDS-C1-SP-300-N/NA	MDS-C1-SP-300	MDS-B-SP-300	MDS-A-SP-300
	MDS-C1-SPH-300	MDS-B-SPH-300	MDS-A-SPH-300
	MDS-C1-SPM-300	-	-
	MDS-C1-SPX-300	MDS-B-SPX-300	-
	MDS-C1-SPHX-300	-	-
MDS-C1-SP-300U-N/NA	MDS-C1-SP-300U	-	-
	MDS-C1-SPH-300U	-	-
MDS-C1-SP-370-N/NA	-	MDS-B-SP-370	-
	-	MDS-B-SPH-370	-
	-	MDS-B-SPM-370	-
	-	MDS-B-SPX-370	-
MDS-C1-SP-450-N/NA	-	MDS-B-SP-450	-
	-	MDS-B-SPH-450	-
	-	MDS-B-SPM-450	-
MDS-C1-SP-550-N/NA	-	MDS-B-SP-550	-
	-	MDS-B-SPH-550	-

(3) Power supply unit

MDS-C1- □ -N Series (Note)	MDS-C1 Series	MDS-B Series	MDS-A Series
MDS-C1-CV-37-N	MDS-C1-CV-37	MDS-B-CV-37	MDS-A-CV-37
		MDS-B-CVS-37	
		MDS-B-CVT-37	
		MDS-B-CVE-37	
MDS-C1-CV-75-N	MDS-C1-CV-55	MDS-B-CV-55	MDS-A-CV-55
		MDS-B-CVS-55	
		MDS-B-CVT-55	
		MDS-B-CVE-55	
	MDS-C1-CV-75	MDS-B-CV-75	MDS-A-CV-75
		MDS-B-CVS-75	
		MDS-B-CVT-75	
		MDS-B-CVE-75	
MDS-C1-CV-110-N	MDS-C1-CV-110	MDS-B-CV-110	MDS-A-CV-110
		MDS-B-CVS-110	
		MDS-B-CVT-110	
		MDS-B-CVE-110	
MDS-C1-CV-185-N	MDS-C1-CV-150	MDS-B-CV-150	MDS-A-CV-150
		MDS-B-CVS-150	
		MDS-B-CVT-150	
		MDS-B-CVE-150	
	MDS-C1-CV-185	MDS-B-CV-185	MDS-A-CV-185
		MDS-B-CVS-185	
		MDS-B-CVT-185	
		MDS-B-CVE-185	
MDS-C1-CV-300-N	MDS-C1-CV-220	MDS-B-CV-220	MDS-A-CV-220
		MDS-B-CVS-220	
		MDS-B-CVT-220	
		MDS-B-CVE-220	
	MDS-C1-CV-260	MDS-B-CV-260	MDS-A-CV-260
		MDS-B-CVS-260	
		MDS-B-CVT-260	
		MDS-B-CVE-260	
	MDS-C1-CV-300	MDS-B-CV-300	MDS-A-CV-300
		MDS-B-CVS-300	
		MDS-B-CVT-300	
		MDS-B-CVE-300	
MDS-C1-CV-370-N	MDS-C1-CV-370	MDS-B-CV-370	-
		MDS-B-CVS-370	
		MDS-B-CVT-370	
		MDS-B-CVE-370	

(Note) Regenerative resistor MDS-A-CR, and large capacity MDS-B-CVE-450 and 550 are not compatible.

1.1.4 List of Encoder Compatibility

Encoder type		MDS-C1-N	MDS-C1	MDS-B-V14/V24	MDS-A/B	
Motor end encoder	ABZ+UVW	OHE25K-6 OHE25K-85	●	×	×	●
	ABZ (+Low-speed serial)	OHA25K-6 OHA25K-85	●	×	×	●
	High-speed serial	OSE104/104S OSA104/104S OSA105 OSE105S OBA17/18 OSA18	●	●	●	●
Ball screw end encoder	ABZ+UVW	OHE25K-ET	●	●	●	●
	ABZ (+Low-speed serial)	OHA25K-ET	●	●	●	●
	High-speed serial	OSE104-ET OSA104-ET OSE105-ET OSA105-ET	●	●	●	●
Machine end encoder	ABZ (+Low-speed serial)	Optical scale Magnescale MPI scale	●	●	●	●
	Low-speed serial	AT41 (Mitutoyo) FME type FLE type (Futaba corporation)	●	●	●	●
	High-speed serial	AT342 (Mitutoyo) LC191M (HEIDENHAIN) MDS-B-HR	●	●	●	●

1.1.5 List of Peripheral Device Compatibility

(1) NC

Model	MDS-C1-N	MDS-C1	MDS-A/B
M500M/L	●	●	●
M600M/L	●	●	●
M64	●	●	●
C5/C6/C64	●	●	●
COS NC(HDLC)	●	●	●

(2) Encoder conversion unit

Model	MDS-C1-N	MDS-C1	MDS-A/B
MDS-B-HR	● *1	●	●
MDS-B-SD	●	●	●
MDS-B-PJEX	●	●	●
MDS-B-MD	×*1	●	●

*1 When driving a linear or direct-drive motor, the unit is not available with MDS-C1-N Series.

(3) Battery

Model	MDS-C1-N	MDS-C1	MDS-A/B
MDS-A-BT- □□	●	●	●
FCU6-BTBOX-36	●	●	●

1.1.6 Function Specifications List

MDS-		C1-CV-N	C1-CV	C1-CVR	B-CV	B-CVE	B-CVS	B-CVT	A-CV
Base control functions	Power regeneration control	●	●	●	●	●	●	●	●
	Contactors control	●	●	●	●	●	●	●	●
Sequence function	External emergency stop	●	●	●	●	●	●	●	-
	High-speed READY ON sequence	●	●	●	-	●	-	●	-
Large capacity spindle		●	●	-	-	●	-	-	-
Power backup		●	-	●	-	-	-	-	-

1.2 Servo/Spindle Drive System Configuration

1.2.1 System Configuration

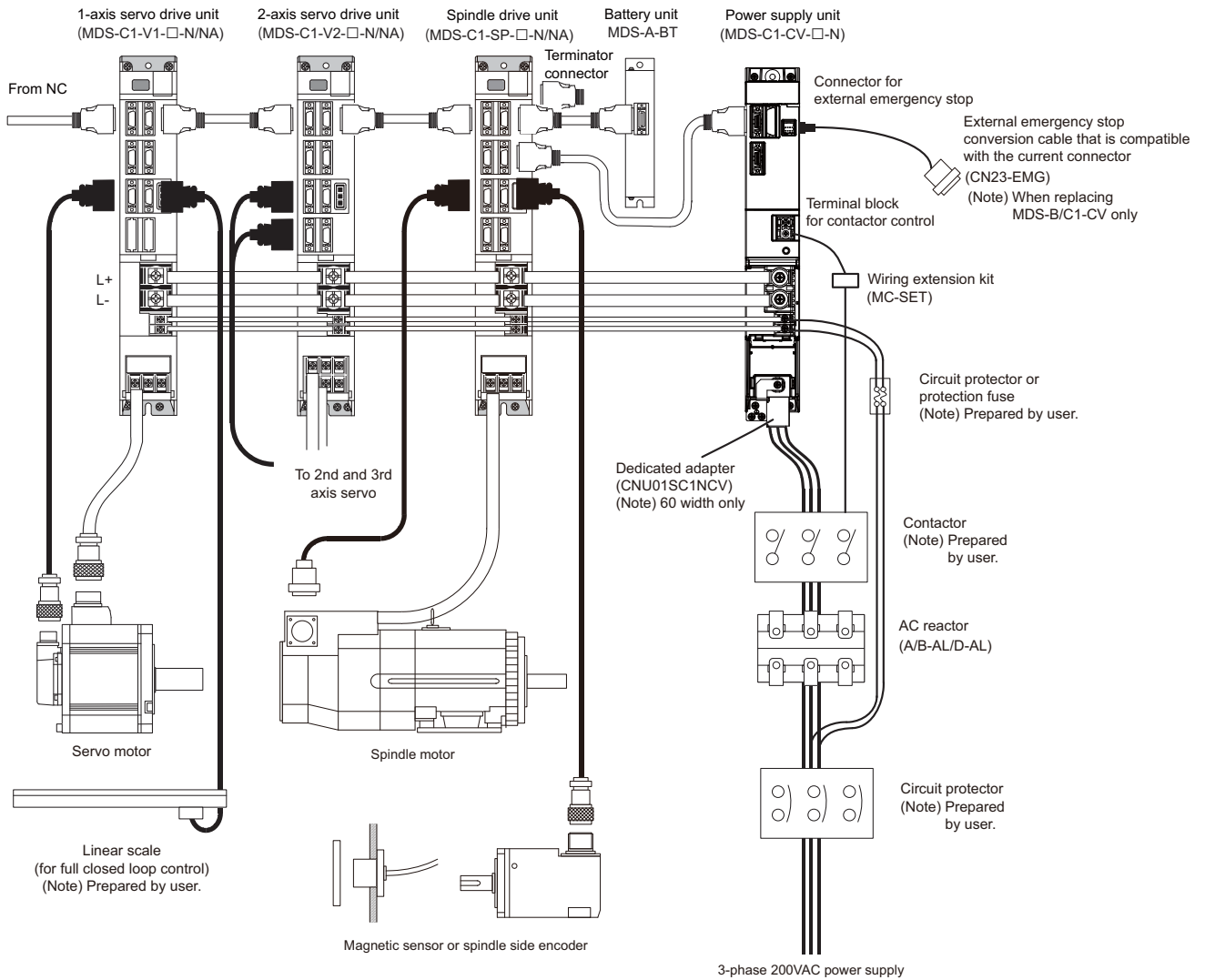

(Note) MDS-C1-N Series can be used with a combination of MDS-A/B/C1 Series.

1.2.2 Servo Drive Unit Type

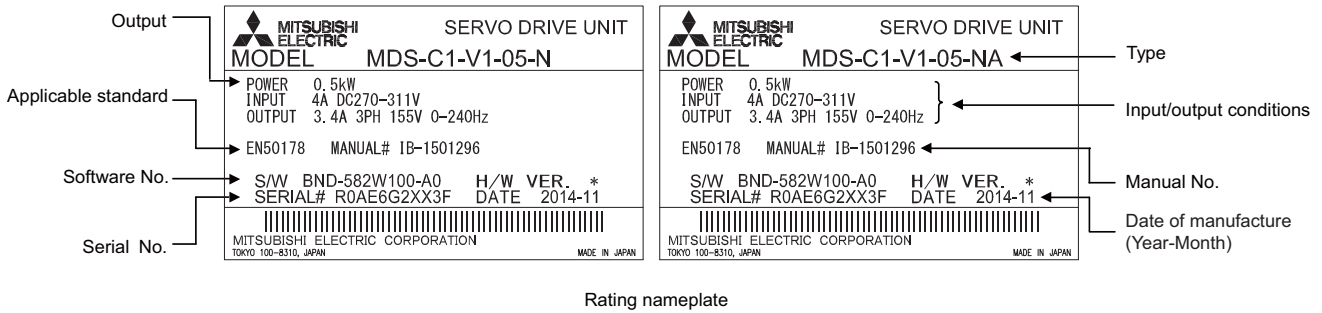

(1) 1-axis servo drive unit

MDS-C1- (1) -N/NA

1-axis servo drive unit			Compatible motor																																						
(1) Motor type MDS-C1-	Capacity (kW)	Unit width	HA□N				HC□												HC□R					HA-LF																	
			053	13	23	33	52	53	102	103	152	153	202	203	352	353	452	453	702	703	902	103	153	203	353	503	11K2	15K2													
V1-01	0.1	60mm	●	●																																					
V1-03	0.3			●	●																																				
V1-05	0.5						●	●																																	
V1-10	1.0								●	●																															
V1-20	2.0	60mm								●	●	●																													
V1-35	3.5												●	●																											
V1-45S	4.5	90mm																																							
V1-45	4.5																																								
V1-70S	7.0																																								
V1-70	7.0	120mm																																							
V1-90	9.0																																								
V1-110	11.0	150mm																																							
V1-150	15.0																																								

● or ▲ indicates the compatible motor for each servo drive unit.
Note continuous operation of ▲ (V1-45S, V1-70S) is limited.

CAUTION

The dynamic brake unit (MDS-B-DBU) is required for the MDS-C1-V1-110/150-NA.

1 Introduction

(2) 2-axis servo drive unit

2-axis servo drive unit			Compatible motor																									
(1) Motor type MDS-C1-	Capacity (kW)	Unit width	Axis	HA□N				HC□												HC□R								
				053	13	23	33	52	53	102	103	152	153	202	203	352	353	452	453	702	703	902	103	153	203	353	503	
V2-0101	0.1+0.1	60mm	LM	●	●																							
V2-0301	0.3+0.1		L			●	●																					
V2-0303	0.3+0.3		M	●	●																							
V2-0501	0.5+0.1		LM			●	●																					
V2-0503	0.5+0.3		L					●	●																			
V2-0505	0.5+0.5		M	●	●																							
V2-1003	1.0+0.3		LM			●	●																					
V2-1005	1.0+0.5		L					●	●																			
V2-1010	1.0+1.0		M	●	●																							
V2-1010	1.0+1.0		LM					●	●																			
V2-2003	2.0+0.3	60mm	L							●	●	●																
V2-2010	2.0+1.0		M		●	●																						
V2-2010	2.0+1.0		L								●	●	●															
V2-2020	2.0+2.0		M							●	●																	
V2-2020	2.0+2.0		LM																									
V2-3510S	3.5+1.0		L																									
V2-3510S	3.5+1.0	M								●	●																	
V2-3520S	3.5+2.0	L																										
V2-3520S	3.5+2.0	M																										
V2-3510	3.5+1.0	90mm	L																									
V2-3510	3.5+1.0		M								●	●																
V2-3520	3.5+2.0		L																									
V2-3520	3.5+2.0		M																									
V2-3535	3.5+3.5		LM																									
V2-4520	4.5+2.0		L																									
V2-4520	4.5+2.0		M																									
V2-4535	4.5+3.5		L																									
V2-4535	4.5+3.5	M																										
V2-4545S	4.5+4.5	LM																										
V2-7070S	7.0+7.0	LM																										
V2-4545	4.5+4.5	120mm	LM																									
V2-7035	7.0+3.5		L																									
V2-7035	7.0+3.5		M																									
V2-7045	7.0+4.5		L																									
V2-7045	7.0+4.5	M																										
V2-7070	7.0+7.0	150mm	LM																									
V2-9090S	9.0+9.0		LM																									

● or ▲ indicates the compatible motor for each servo drive unit.
 Note continuous operation of ▲ (V2-4545S, V2-7070S, V2-9090S) is limited.

CAUTION

1. The MDS-C1-V2-3510/3520-NA shape is compatible with the MDS-B Series. When newly incorporating the MDS-C1 Series, use the MDS-C1-V2-3510S/3520S-NA.
2. Limits apply to continuous operation of the MDS-C1-V2-4545S/9090S-NA.

1.2.3 Spindle Drive Unit Type

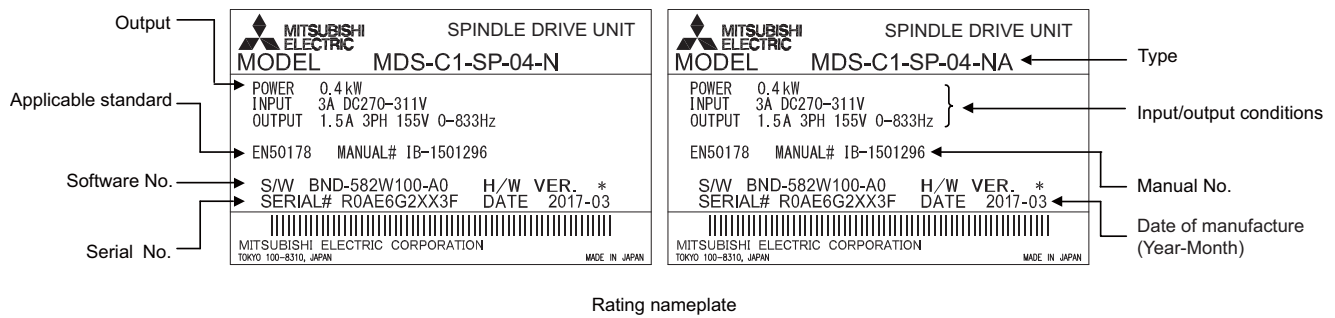

(1) Spindle drive unit

MDS-C1 - (1) - (2) - N/NA

(2) Capacity

Symbol	Capacity (kW)	Unit width (outline type)
04	0.4	60 (A0)
075	0.75	
15	1.5	
22	2.2	60 (A1)
37	3.7	
55	5.5	90 (B1)
75	7.5	
110	11.0	
150S	15.0	
150	15.0	120 (C1)
185	18.5	
220	22.0	150 (D1)
260	26.0	150 (D2)
260U	26.0	150 (D1)
300	30.0	150 (D2)
300U	30.0	150 (D1)
370	37.0	240 (E1)
450	45.0	300 (F1)
550	55.0	

(1) Spindle drive unit series

Symbol	Compatible motor rotation speed	Details
SP	Less than 10,000 r/min	IM standard specifications
SPH	10,000 r/min or more	
SPX	Less than 10,000 r/min	IM encoder conversion unit compatible specifications (MDS-B-PJEX unit can be connected)
SPHX	10,000 r/min or more	
SPM	All ranges	IPM motor compatible specifications (Use to drive the IPM spindle motor)

1.2.4 Power Supply Unit Type

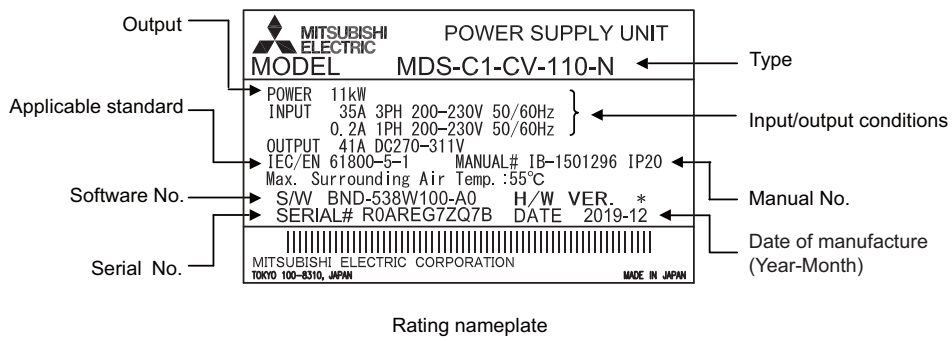

(1) Power supply unit

MDS-C1-CV- (1) -N

Power supply unit					
(1) Type MDS-C1-CV-□-N	Capacity (kW)	Outline type (unit width)	Compatible AC reactor	Compatible contactor (Mitsubishi)	Compatible circuit protector (Mitsubishi)
37	3.7	60 (A2)	A/B/D-AL-7.5K	SK25-AC200V S-N25 200V S-T12-AC200V	NF50CS3P-40A05 NF63-CW3P-20A
75	7.5			SK25-AC200V S-N25 200V S-T35-AC200V	NF50CS3P-40A05 NF63-CW3P-40A
110	11.0	90 (B1)	A/B/D-AL-11K	SK35-AC200V S-N35 200V S-T35-AC200V	NF50CS3P-50A05 NF63-CW3P-50A
185	18.5	120 (C1)	A/B/D-AL-18.5K	SK50-AC200V S-N50 200V S-T65-AC200V	NF100CS3P-100A05 NF125-CW3P-100A
300	30.0	150 (D1)	A/B/D-AL-30K	SK80-AC200V S-N80 200V S-T80-AC200V	NF225CS3P-150A05 NF250-CW3P-125A
370	37.0			A/B/D-AL-37K	SK150-AC200V S-N150 200V S-N150-AC200V

2

Specifications

2.1 Drive Unit

2.1.1 Installation Environment Conditions

Common installation environment conditions for servo, spindle and power supply unit are shown below.

Environ- ment	Ambient temperature	Operation: 0 to 55°C (with no freezing), Storage / Transportation: -15°C to 70°C (with no freezing)
	Ambient humidity	Operation: 90%RH or less (with no dew condensation) Storage / Transportation: 90%RH or less (with no dew condensation)
	Atmosphere	Indoors (no direct sunlight) With no corrosive gas, inflammable gas, oil mist, dust or conductive fine particles
	Altitude	Operation/Storage: 1000 meters or less above sea level, Transportation: 10000 meters or less above sea level
	Vibration/impact	4.9m/s ² (0.5G) / 49m/s ² (5G)

2.1.2 Servo Drive Unit

(1) 1-axis servo drive unit

		1-axis servo drive unit MDS-C1-V1-□ -N/NA Series												
Servo drive unit type MDS-C1-V1-□ -N/NA		01	03	05	10	20	35	45S	45	70S	70	90	110	150
Rated output [kW]		0.1	0.3	0.5	1.0	2.0	3.5	4.5	4.5	7.0	7.0	9.0	11.0	15.0
Output	Rated voltage [V]	155AC												
	Rated current [A]	0.95	2.9	3.4	6.8	13.0	19.0	28.0	28.0	33.5	33.5	42.0	68.0	87.0
Input	Rated voltage [V]	270 to 311DC												
	Rated current [A]	1	3	4	7	14	17	30	30	35	35	45	55	75
Control power	Voltage [V]	200 to 230AC												
	Frequency [Hz]	50/60												
	Maximum current [A]	0.2												
	Maximum rush current [A]	35												
	Maximum rush conductivity time [ms]	6												
Maximum earth leakage current [mA]		2												
Control method		Sine wave PWM control method / Current control method												
Braking	Regenerative braking and dynamic brakes													
	Dynamic brakes	Built-in										External		
External analog output		0 to +5V, 2ch (data for various adjustments)												
Degree of protection		IP20 (excluding terminal block)												
Cooling method		Natural-cooling					Forced air cooling (fin)							
Mass [kg]		2.8			3.5			4.3	5.0	5.9		6.7		
Heat radiated at rated output [W]		21	27	37	53	91	132	158	185	189	284	331	465	641
Unit outline dimension drawing		A0			A1			B1		C1		D2		

2 Specifications

(2) 2-axis servo drive unit

		2-axis servo drive unit MDS-C1-V2- □ -N/NA Series													
Servo drive unit type MDS-C1-V2- □ -N/NA		0101	0301	0303	0501	0503	0505	1003	1005	1010	2003	2010	2020	3510S	3510
Rated output [kW]		0.1 +	0.3 +	0.3 +	0.5 +	0.5 +	0.5 +	1.0 +	1.0 +	1.0 +	2.0 +	2.0 +	2.0 +	3.5 +	3.5 +
		0.1	0.1	0.3	0.1	0.3	0.5	0.3	0.5	1.0	0.3	1.0	2.0	1.0	1.0
Output	Rated voltage [V]	155AC													
	Rated current [A]	0.95 +	2.9 +	2.9 +	3.4 +	3.4 +	3.4 +	6.8 +	6.8 +	6.8 +	13.0 +	13.0 +	13.0 +	16.0 +	16.0 +
		0.95	0.95	2.9	0.95	2.9	3.4	2.9	3.4	6.8	6.8	13.0	13.0	13.0	16.0
Input	Rated voltage [V]	270 to 311AC													
	Rated current [A]	2	4	6	5	7	8	10	11	14	17	21	28	24	24
Control power	Voltage [V]	200 to 230AC													
	Frequency [Hz]	50/60													
	Maximum current [A]	0.2													
	Maximum rush current [A]	35													
	Maximum rush conductivity time [ms]	6													
Maximum earth leakage current [mA]		4													
Control method		Sine wave PWM control method / Current control method													
Braking		Regenerative braking and dynamic brakes													
Dynamic brakes		Built-in													
External analog output		0 to +5V, 2ch (data for various adjustments)													
Degree of protection		IP20 (excluding terminal block)													
Cooling method		Natural-cooling									Forced air cooling (fin)				
Mass [kg]		3.5									4.3			5.2	
Heat radiated at rated output [W]		38	41	43	46	52	62	68	78	96	127	155	178	190	190
Unit outline dimension drawing		A0									A1			B1	

		2-axis servo drive unit MDS-C1-V2- □ -N/NA Series												
Servo drive unit type MDS-C1-V2- □ -N/NA		3520S	3520	3535	4520	4535	4545S	4545	7035	7045	7070S	7070	9090S	
Rated output [kW]		3.5 +	3.5 +	3.5 +	4.5 +	4.5 +	4.5 +	4.5 +	7.0 +	7.0 +	7.0 +	7.0 +	9.0 +	
		2.0	2.0	3.5	2.0	3.5	4.5	4.5	3.5	4.5	7.0	7.0	9.0	
Output	Rated voltage [V]	155AC												
	Rated current [A]	16.0 +	16.0 +	16.0 +	28.0 +	28.0 +	28.0 +	28.0 +	33.5 +	33.5 +	33.5 +	33.5 +	40.8 +	
		13.0	13.0	16.0	16.0	16.0	28.0	28.0	16.0	28	33.5	33.5	40.8	
Input	Rated voltage [V]	270 to 311AC												
	Rated current [A]	31	31	34	44	47	60	60	52	64	70	70	90	
Control power	Voltage [V]	200 to 230AC												
	Frequency [Hz]	50/60												
	Maximum current [A]	0.2												
	Maximum rush current [A]	35												
	Maximum rush conductivity time [ms]	6												
Maximum earth leakage current [mA]		4												
Control method		Sine wave PWM control method / Current control method												
Braking		Regenerative braking and dynamic brakes												
Dynamic brakes		Built-in												
External analog output		0 to +5V, 2ch (data for various adjustments)												
Degree of protection		IP20 (excluding terminal block)												
Cooling method		Forced air cooling (fin)												
Mass [kg]		4.3	5.2	5.2	5.2	5.2	5.2	5.9	6.6	6.6	5.9	7.5	7.5	
Heat radiated at rated output [W]		213	213	260	266	307	280	359	406	459	365	558	558	
Unit outline dimension drawing		A1	B1					C1			B1	D2		

2 Specifications

2.1.3 Spindle Drive Unit

(1) 1-axis spindle drive unit

		1-axis spindle drive unit MDS-C1-SP- □ -N/NA Series											
Spindle drive unit type MDS-C1-SP- □ -N/NA		04	075	15	22	37	55	75	110	150S	150	185	
Rated output [kW]		0.4	0.75	1.5	2.2	3.7	5.5	7.5	11.0	15.0	15.0	18.5	
Output	Rated voltage [V]	155AC											
	Rated current [A]	1.5	2.6	4.5	10.0	15.0	18.0	26.0	37.0	49.0	49.0	63.0	
Input	Rated voltage [V]	270 to 311DC											
	Rated current [A]	3.0	4.0	7.0	13.0	17.0	20.0	30.0	41.0	58.0	58.0	76.0	
Control power	Voltage [V]	200 to 230AC											
	Frequency [Hz]	50/60											
	Maximum current [A]	0.2											
	Maximum rush current [A]	35											
	Maximum rush conductivity time [ms]	6											
Maximum earth leakage current [mA]		15											
Control method		Sine wave PWM control method / Current control method											
Braking		Regenerative braking											
External analog output		0 to +10V, 2ch (data for various adjustments)											
Degree of protection		IP20 (excluding terminal block)											
Cooling method		Natural-cooling				Forced air cooling (fin)							
Mass [kg]		2.8			3.5		4.3			4.9	5.9		
Heat radiated at rated output [W]		30	40	49	69	79	108	137	181	188	235	342	
Unit outline dimension drawing		A0			A1		B1			C1			

		1-axis spindle drive unit MDS-C1-SP- □ -N/NA Series							
Spindle drive unit type MDS-C1-SP- □ -N/NA		220	260	260U	300	300U	370	450	550
Rated output [kW]		22.0	26.0	26.0	30.0	30.0	37.0	45.0	55.0
Output	Rated voltage [V]	155AC							
	Rated current [A]	79.0	97.0	97.0	130	130	146	173	205
Input	Rated voltage [V]	270 to 311DC							
	Rated current [A]	95.0	115	115	144	144	164	198	238
Control power	Voltage [V]	200 to 230AC							
	Frequency [Hz]	50/60							
	Maximum current [A]	0.2							
	Maximum rush current [A]	35							
	Maximum rush conductivity time [ms]	6							
Maximum earth leakage current [mA]		15							
Control method		Sine wave PWM control method / Current control method							
Braking		Regenerative braking							
External analog output		0 to +10V, 2ch (data for various adjustments)							
Degree of protection		IP20 (excluding terminal block)							
Cooling method		Forced air cooling (fin)							
Mass [kg]		6.5	6.8	8.8	6.8	8.8	16.0	18.8	
Heat radiated at rated output [W]		366	483	483	620	620	850	1000	1200
Unit outline dimension drawing		D1	D2	D1	D2	D1	E1	F1	

2.1.4 Power Supply Unit

		Power supply unit MDS-C1-CV- □ -N Series					
Power supply unit type MDS-C1-CV- □ -N		37	75	110	185	300	370
Rated output [kW]		3.7	7.5	11.0	18.5	30.0	37.0
Input	Rated voltage [V]	200 to 230AC Tolerable fluctuation : between +10% and -15%					
	Frequency [Hz]	50/60 Tolerable fluctuation : between +3% and -3%					
	Rated current [A]	15	26	35	65	107	121
Output	Rated voltage [V]	270 to 311DC					
	Rated current [A]	17	30	41	76	144	164
Control power	Voltage [V]	200 to 230AC Tolerable fluctuation : between +10% and -15%					
	Frequency [Hz]	50/60 Tolerable fluctuation : between +3% and -3%					
	Maximum current [A]	0.2					
	Maximum rush current [A]	35					
	Maximum rush conductivity time [ms]	6					
Main circuit method		Converter with power regeneration circuit					
Degree of protection		IP20 (excluding terminal block)					
Cooling method		Natural-cooling			Forced air cooling		
Mass [kg]		3.5		5.8	5.9	10.7	
Heat radiated at rated output [W]		54	79	124	193	317	396
Unit outline dimension drawing		A2		B1	C1	D1	

2.1.5 AC Reactor

An AC reactor must be installed for each power supply unit.

(1) 200V series

< MDS-C1-N Series >

		AC reactor				
AC reactor model D-AL-	7.5K	11K	18.5K	30K	37K	
Compatible power supply unit type MDS-C1-CV- □ -N	37, 75	110	185	300	370	
Rated capacity [kW]	7.5	11	18.5	30	37	
Rated voltage [V]	200 to 230AC					
Rated current [A]	27	40	66	110	133	
Frequency [Hz]	50/60 Tolerable fluctuation : between +3% and -3%					
Environment	Ambient temperature	Operation: -10°C to 60°C (with no freezing), Storage/Transportation: -10°C to 60°C (with no freezing)				
	Ambient humidity	Operation: 80%RH or less (with no dew condensation), Storage/Transportation: 80%RH or less (with no dew condensation)				
	Atmosphere	Indoors (no direct sunlight) With no corrosive gas, inflammable gas, oil mist or dust				
	Altitude	Operation/Storage: 1000 meters or less above sea level, Transportation: 10000 meters or less above sea level				
	Vibration / impact	9.8m/s ² (1G) / 98m/s ² (10G)				
Mass [kg]	4.2	3.7	5.3	6.1	8.6	



CAUTION

A/B-AL or D-AL is used for MDS-C1-N Series.

2.1.6 Unit Outline Drawing

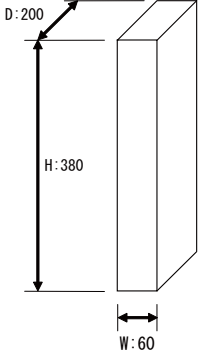
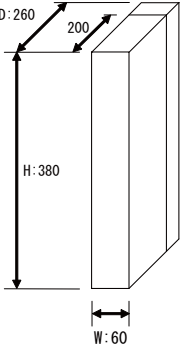
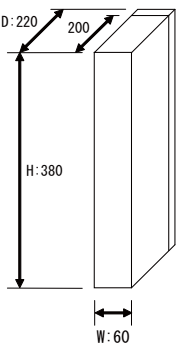
Unit outline type	A0	A1	A2
Outline dimensions [mm]	 <p>Wiring allowance at front: 50mm A0 type does not have fins</p>	 <p>Wiring allowance at front: 50mm Required ventilation space at back: 15mm</p>	 <p>Wiring allowance at front: 50mm Heat radiation allowance at back: 15mm</p>
Heat dissipation method	In-panel heat radiation	Heat radiated outside panel (forced air cooling)	Heat radiated outside panel (natural air cooling)

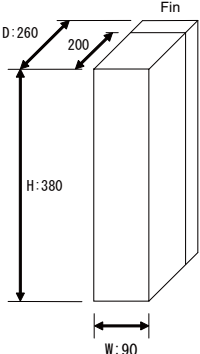
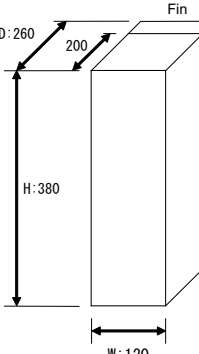
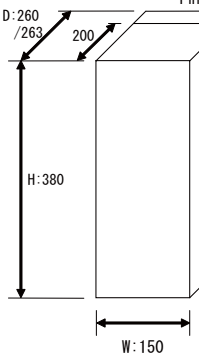
Unit outline type	B1	C1	D1/D2
Outline dimensions [mm]	 <p>Wiring allowance at front: 50mm Required ventilation space at back: 15mm</p>	 <p>Wiring allowance at front: 50mm Required ventilation space at back: 15mm</p>	 <p>Wiring allowance at front: 50mm Required ventilation space at back: 15mm (D2: 12mm)</p>
Heat dissipation method	Heat radiated outside panel (forced air cooling)	Heat radiated outside panel (forced air cooling)	Heat radiated outside panel (forced air cooling)

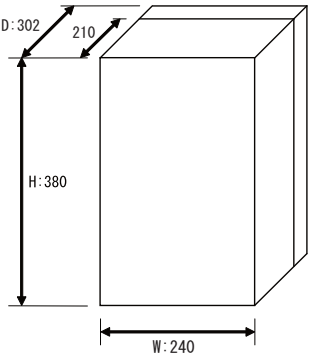
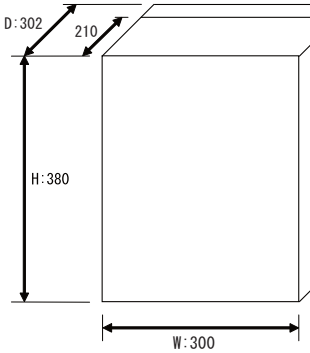
Unit outline type	E1	F1
Outline dimensions [mm]	 <p>Wiring allowance at front: 50mm Required ventilation space at back: 22mm</p>	 <p>Wiring allowance at front: 50mm Required ventilation space at back: 22mm</p>
Heat dissipation method	Heat radiated outside panel (forced air cooling)	Heat radiated outside panel (forced air cooling)

2.1.7 Unit Outline Dimension Drawing

MDS-C1-Vx-□-N/NA Series

(1) 60 width Without fin

- MDS-C1-V2-0101-N/NA
- MDS-C1-V2-0301-N/NA
- MDS-C1-V2-0303-N/NA
- MDS-C1-V2-0501-N/NA
- MDS-C1-V2-0503-N/NA
- MDS-C1-V2-0505-N/NA
- MDS-C1-V1-01-N/NA
- MDS-C1-V1-03-N/NA
- MDS-C1-V1-05-N/NA
- MDS-C1-V1-10-N/NA
- MDS-C1-V2-1003-N/NA
- MDS-C1-V2-1005-N/NA
- MDS-C1-V2-1010-N/NA
- MDS-C1-SP-04-N/NA
- MDS-C1-SP-075-N/NA
- MDS-C1-SP-15-N/NA

[Unit: mm]

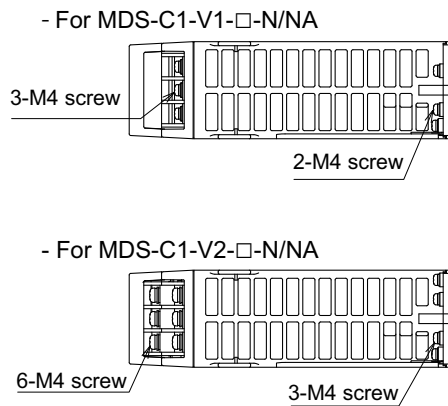
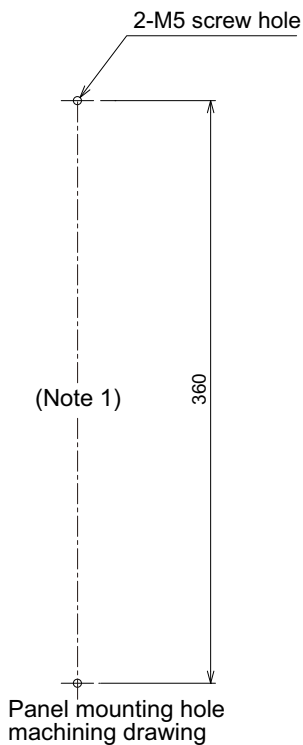
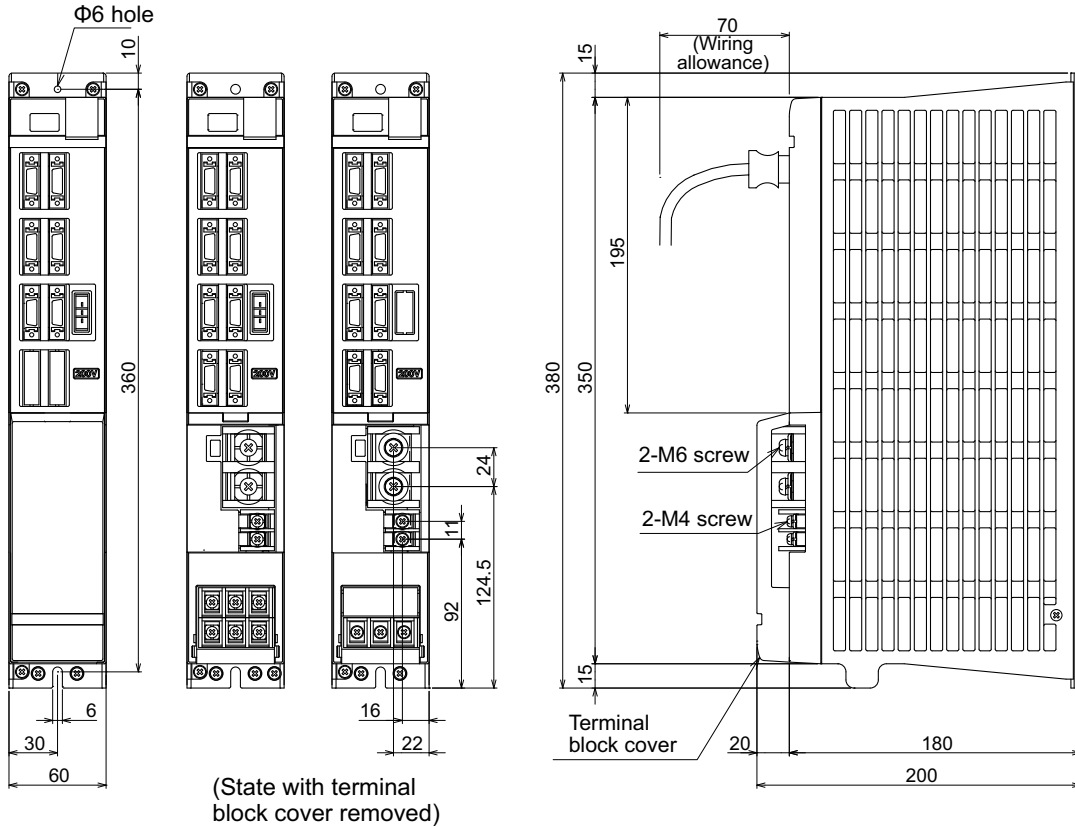

(Note 1) The square hole does not need to be machined.

(2) 60 width

MDS-C1-V2-2010-N/NA
 MDS-C1-V1-20-N/NA MDS-C1-V2-2020-N/NA
 MDS-C1-V1-35-N/NA MDS-C1-V2-3510S-N/NA MDS-C1-SP-22-N/NA
 MDS-C1-V1-45S-N/NA MDS-C1-V2-3520S-N/NA MDS-C1-SP-37-N/NA

[Unit: mm]

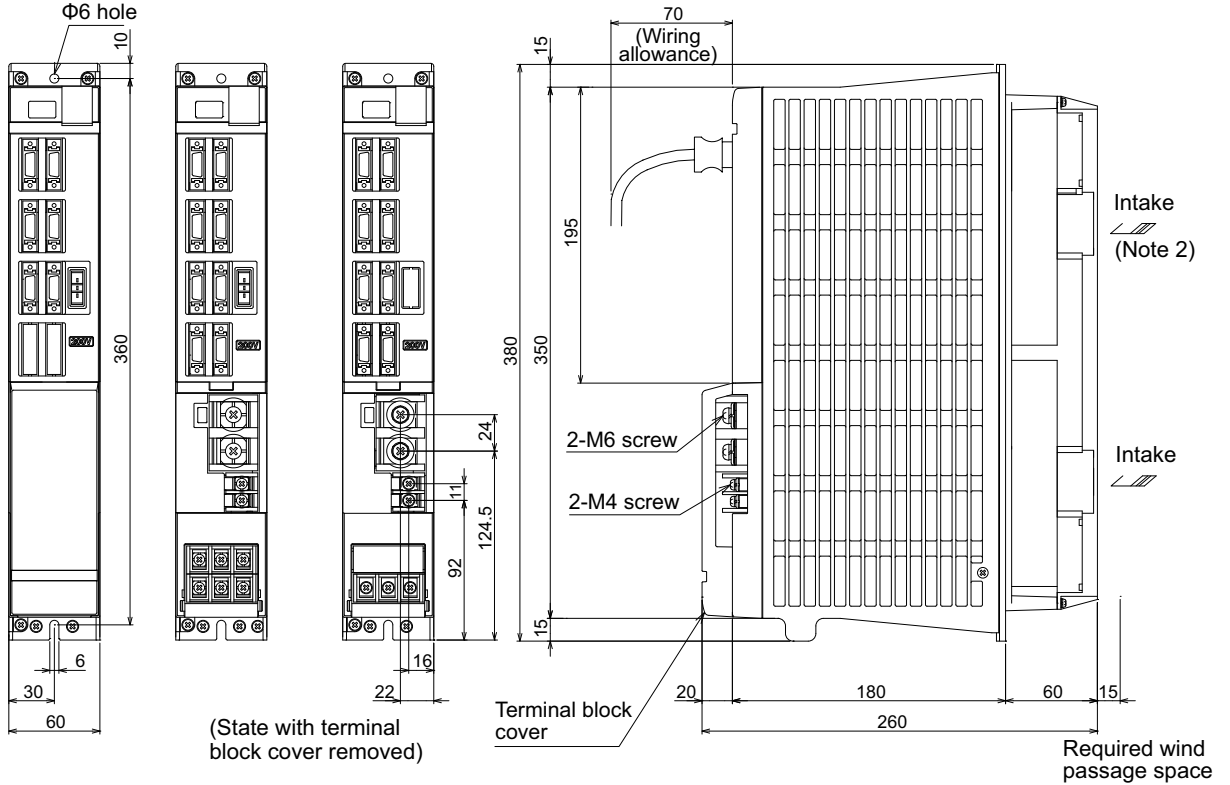

(State with terminal block cover removed)

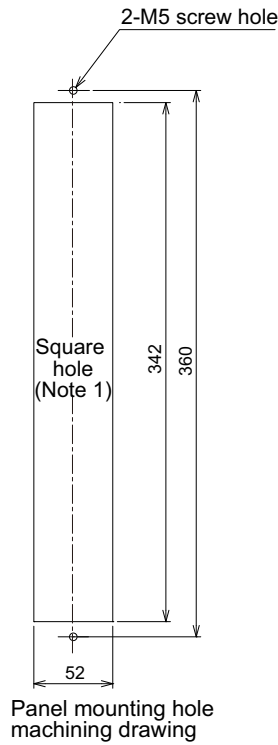

Panel mounting hole machining drawing

- For MDS-C1-V1-□-N/NA

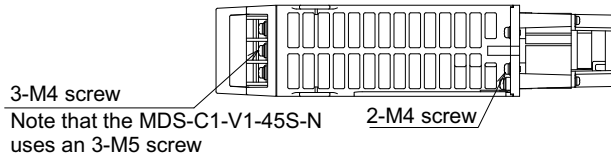

- For MDS-C1-V2-□-N/NA

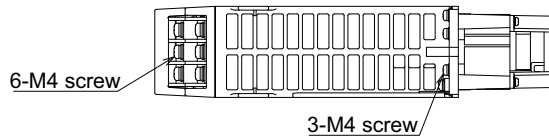

(Note 1) Attach packing around the square hole for sealing.
 (Note 2) The MDS-C1-V1-20-N does not have a fan at the top.

2 Specifications

(3) 90 width

MDS-C1-V1-45-N/NA

MDS-C1-V1-70S-N/NA

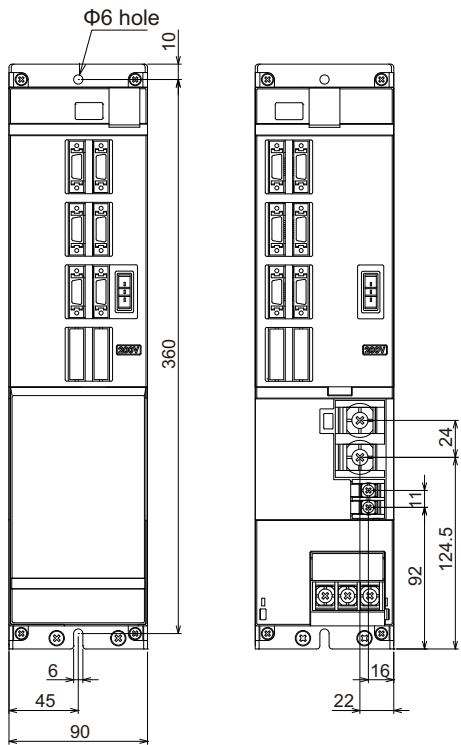

(State with terminal block cover removed)

2-M5 screw hole

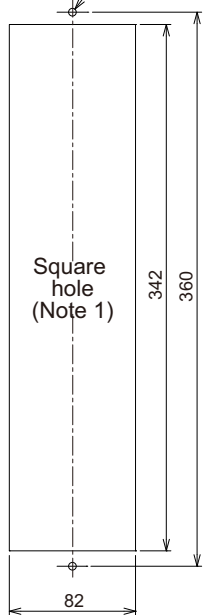

Panel mounting hole machining drawing

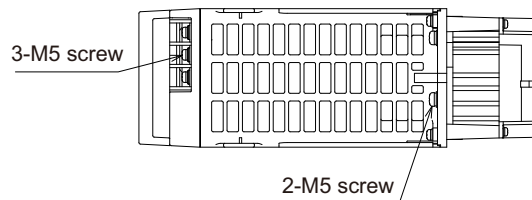
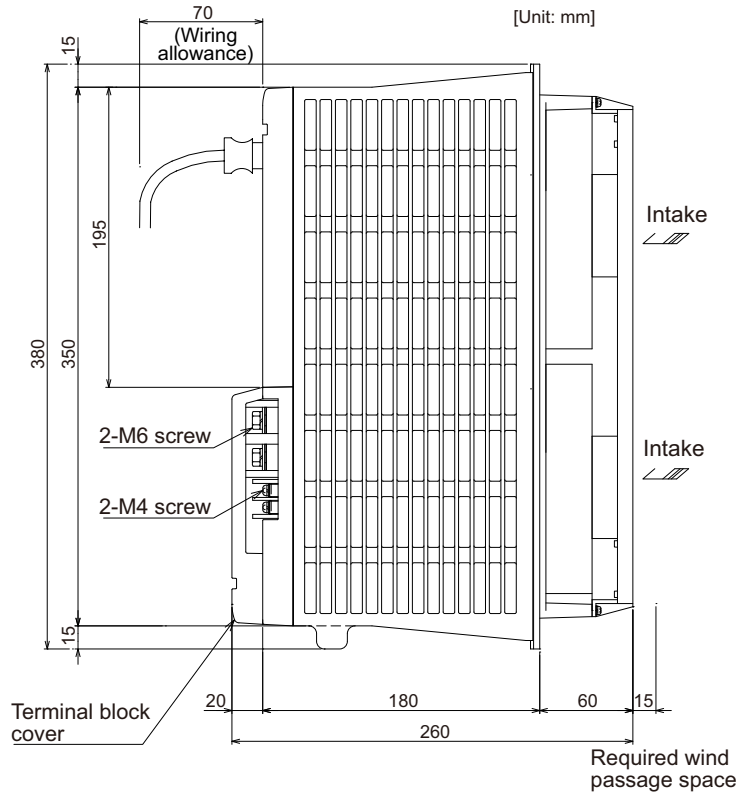

(Note 1) Attach packing around the square hole for sealing.

MDS-C1-V2-3510-N/NA
 MDS-C1-V2-3520-N/NA
 MDS-C1-V2-3535-N/NA
 MDS-C1-V2-4520-N/NA
 MDS-C1-V2-4535-N/NA
 MDS-C1-V2-4545S-N/NA MDS-C1-V2-7070S-N/NA

[Unit: mm]

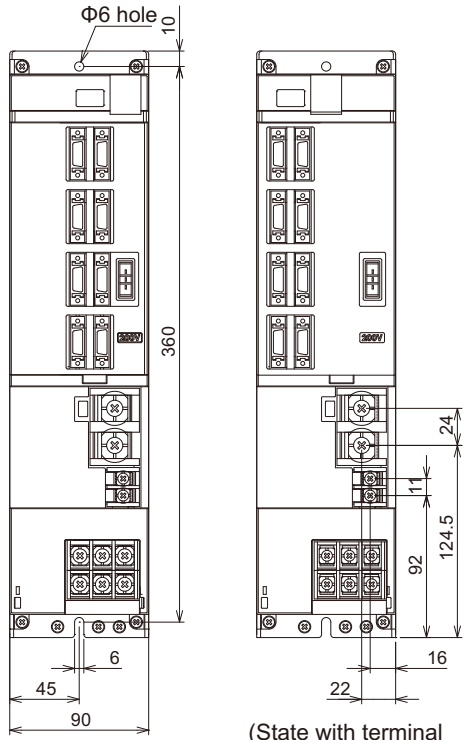

(State with terminal block cover removed)

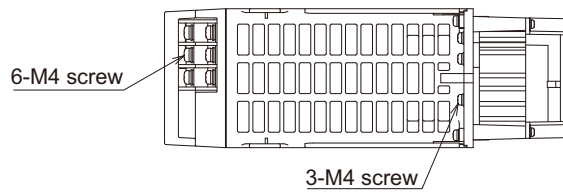
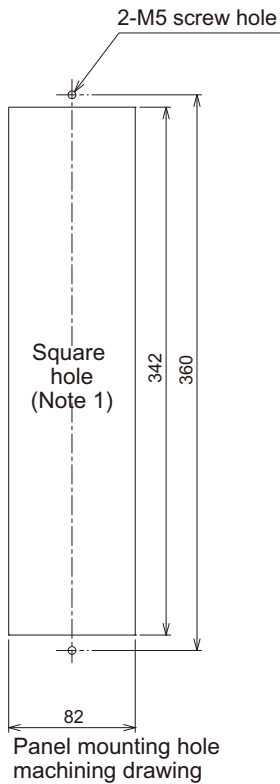
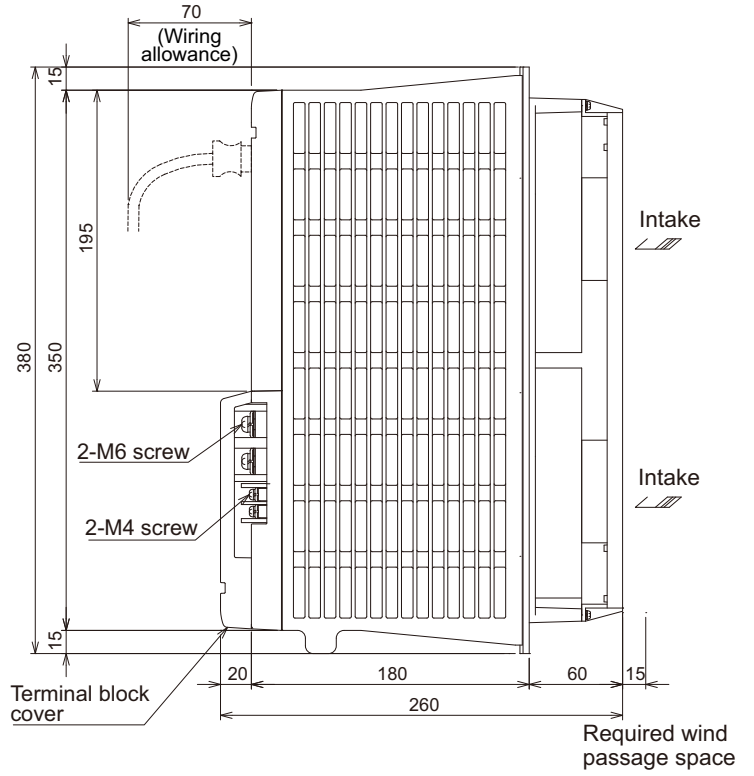

(Note 1) Attach packing around the square hole for sealing.

2 Specifications

MDS-C1-SP-55-N/NA
 MDS-C1-SP-75-N/NA
 MDS-C1-SP-110-N/NA

MDS-C1-SP-150S-N/NA

[Unit: mm]

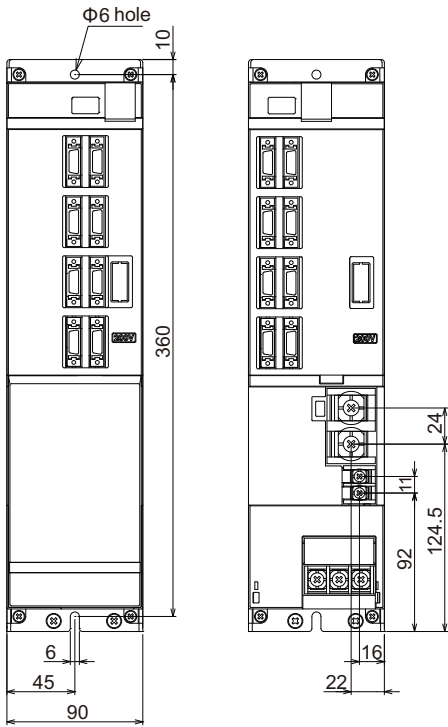

(State with terminal block cover removed)

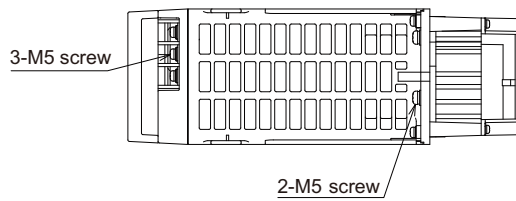
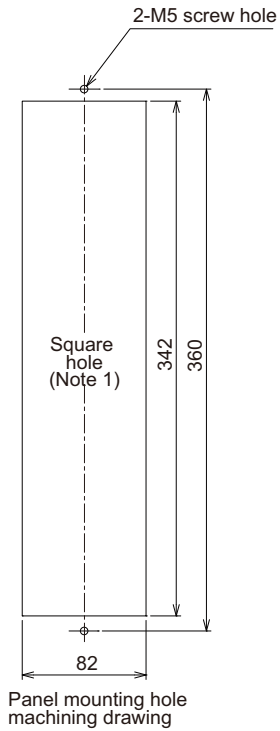
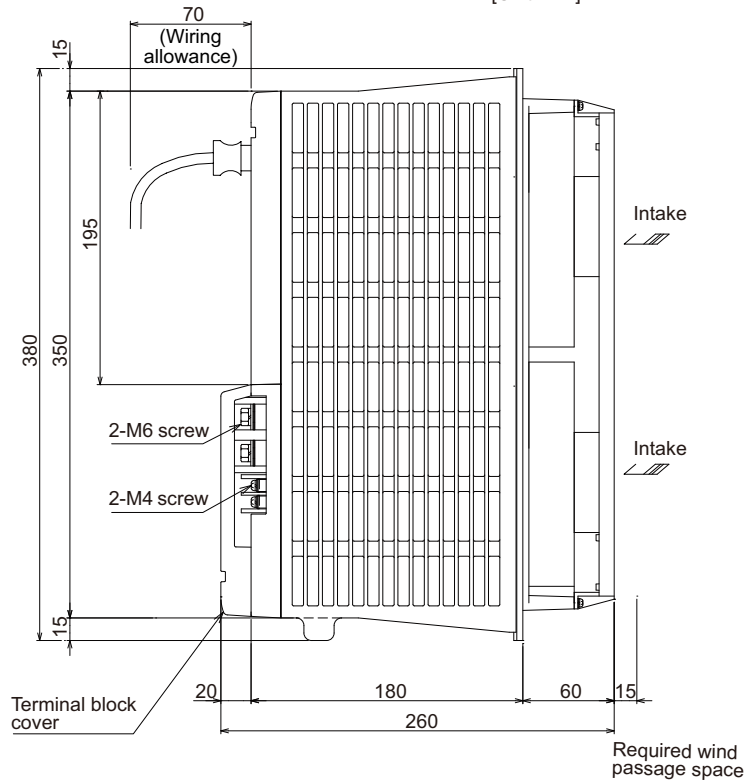

(Note 1) Attach packing around the square hole for sealing.

(4) 120 width

MDS-C1-V1-70-N/NA
MDS-C1-V1-90-N/NA

MDS-C1-SP-150-N/NA
MDS-C1-SP-185-N/NA

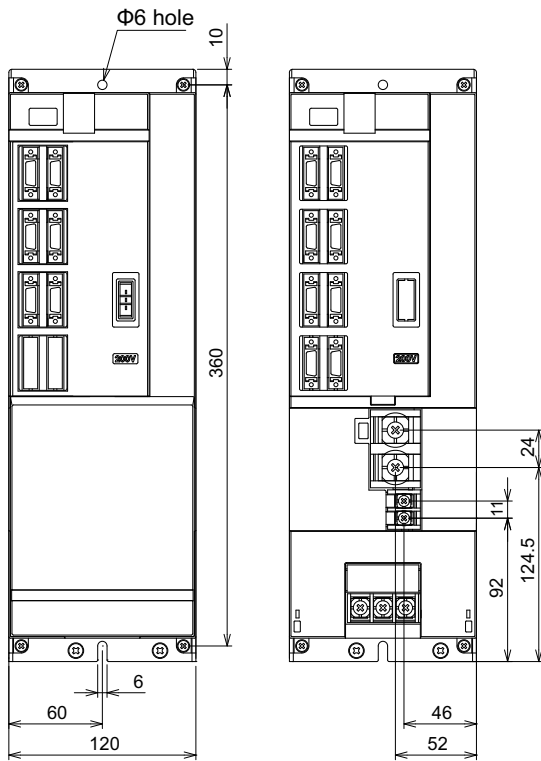

(State with terminal block cover removed)

[Unit: mm]

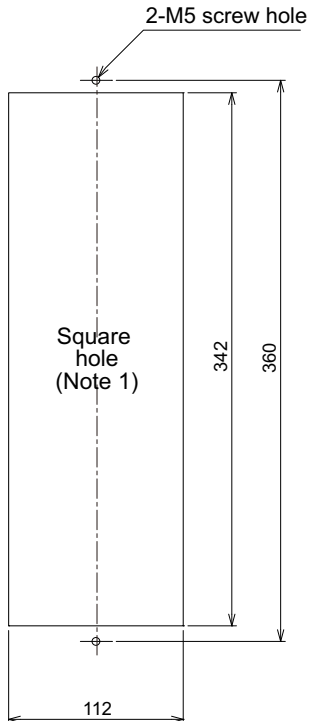
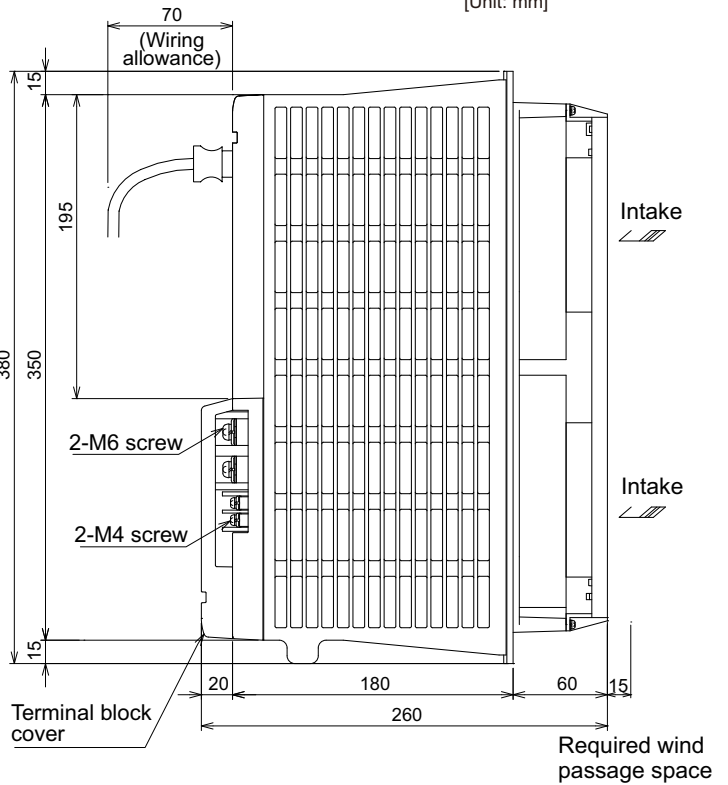

Panel mounting hole machining drawing

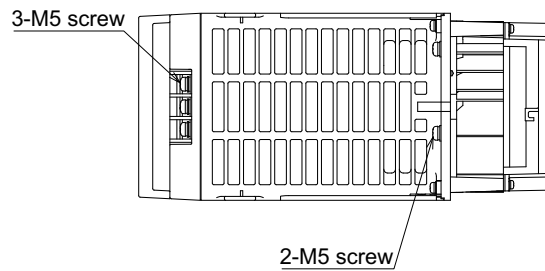

(Note 1) Attach packing around the square hole for sealing.

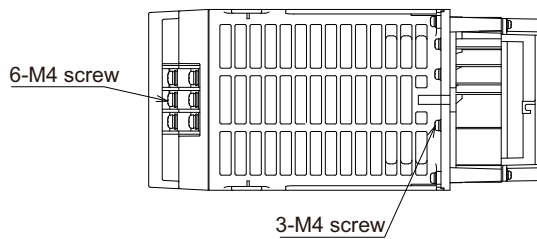
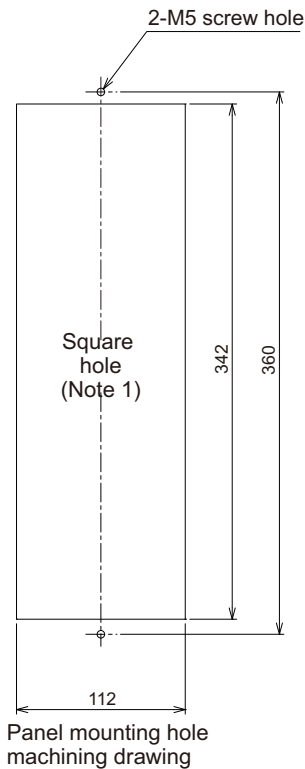
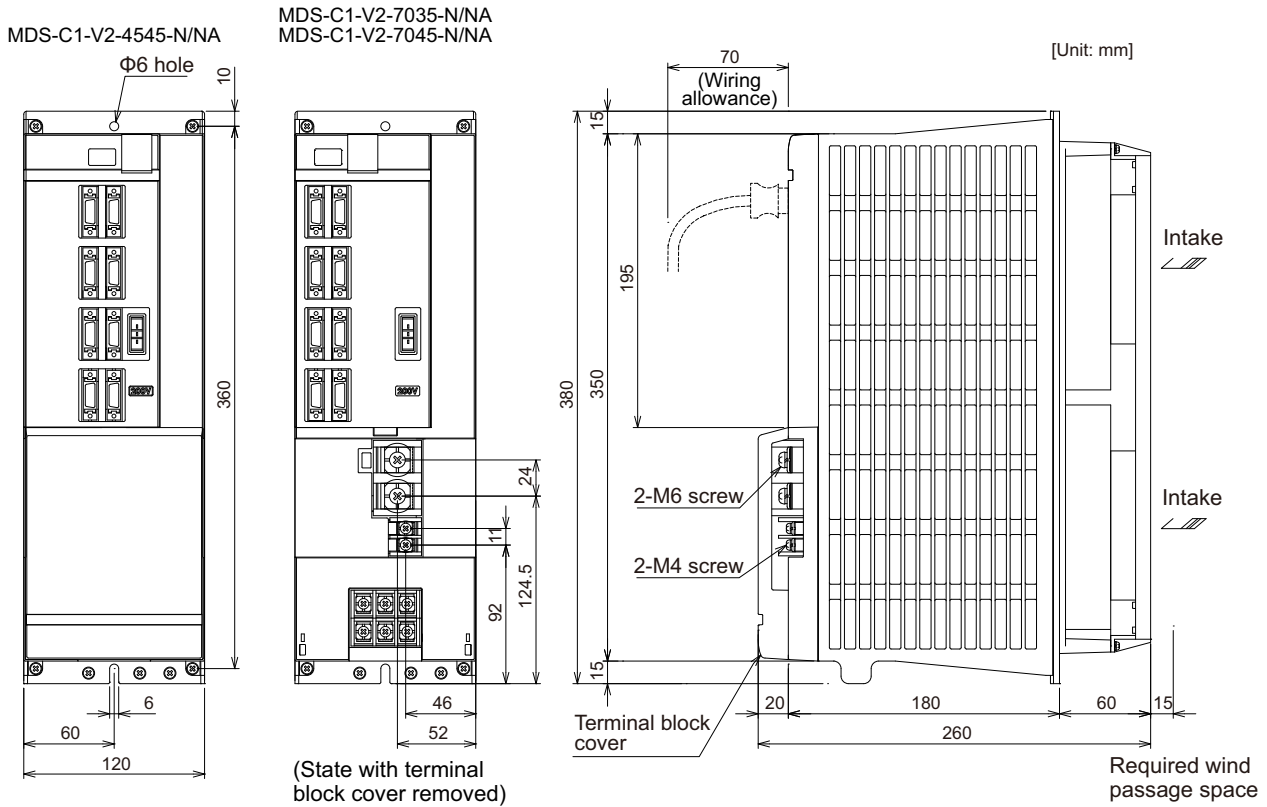

(Note 1) Attach packing around the square hole for sealing.

(5) 150 width

MDS-C1-SP-220-N/NA
 MDS-C1-SP-260U-N/NA MDS-C1-V2-7070-N/NA
 MDS-C1-SP-300U-N/NA MDS-C1-V2-9090S-N/NA

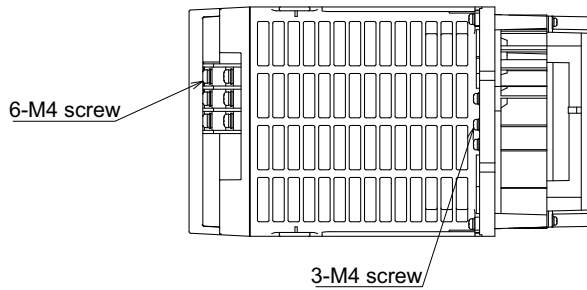
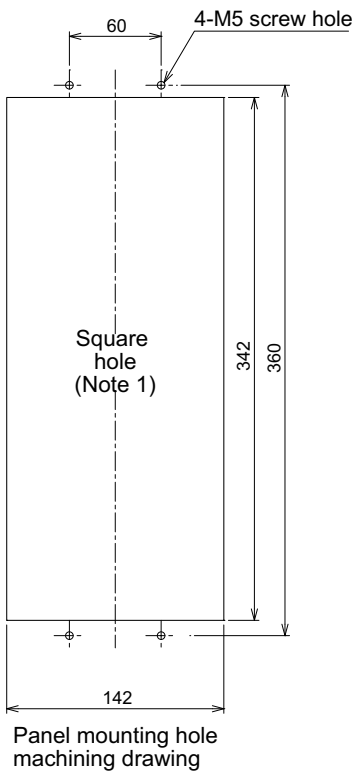
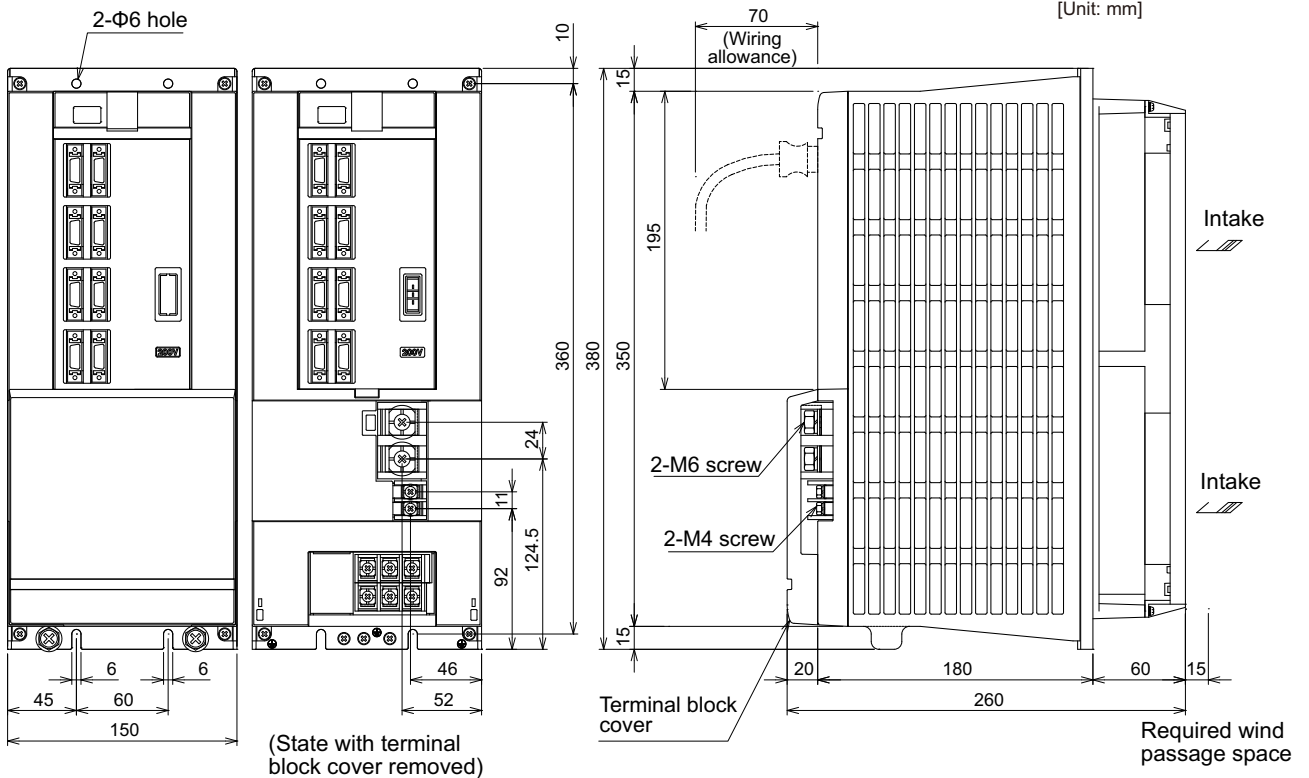

(Note 1) Attach packing around the square hole for sealing.

2 Specifications

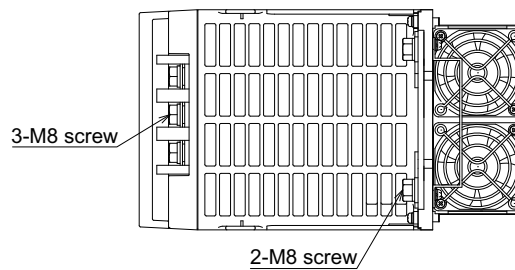
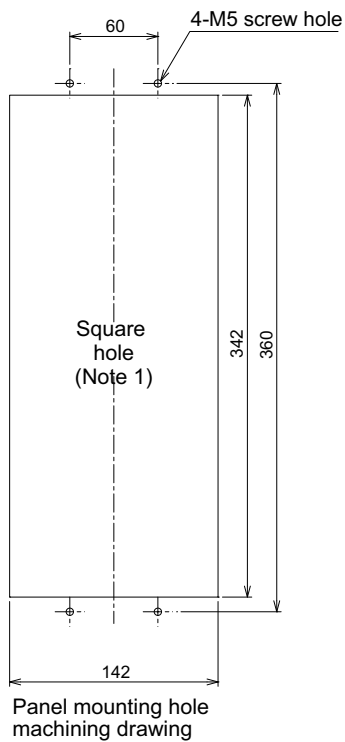
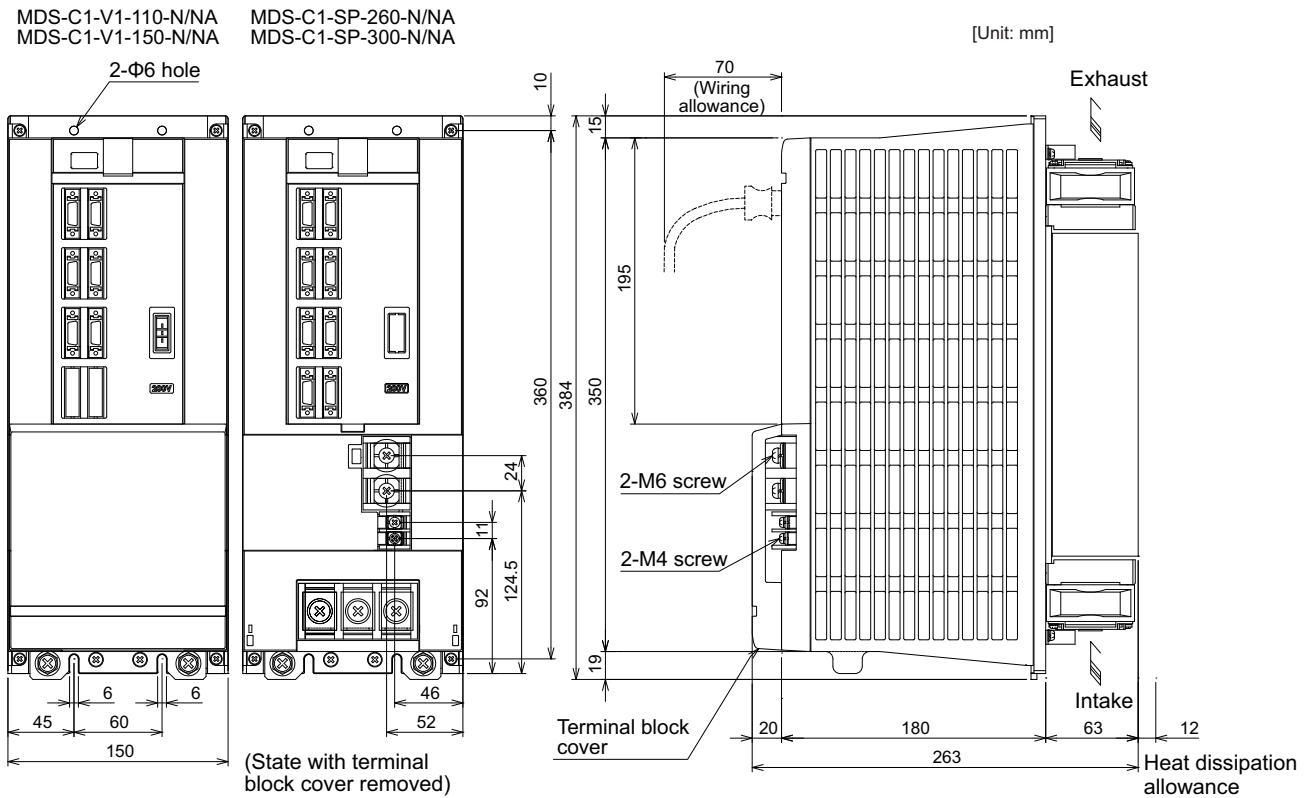

(Note 1) Attach packing around the square hole for sealing.

(6) 240 width

MDS-C1-SP-370-N/NA

[Unit: mm]

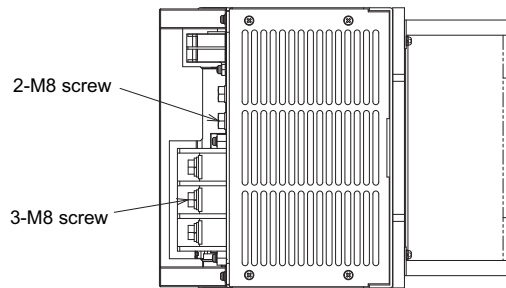
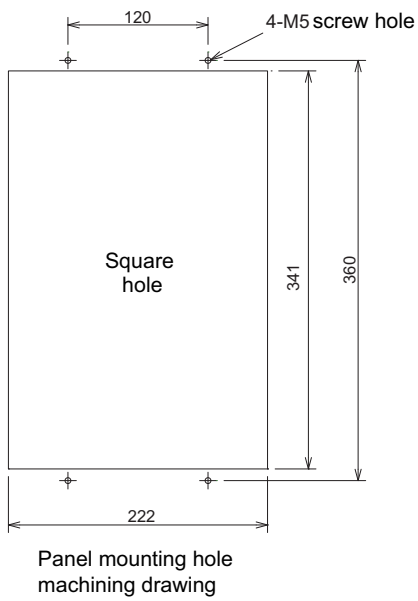
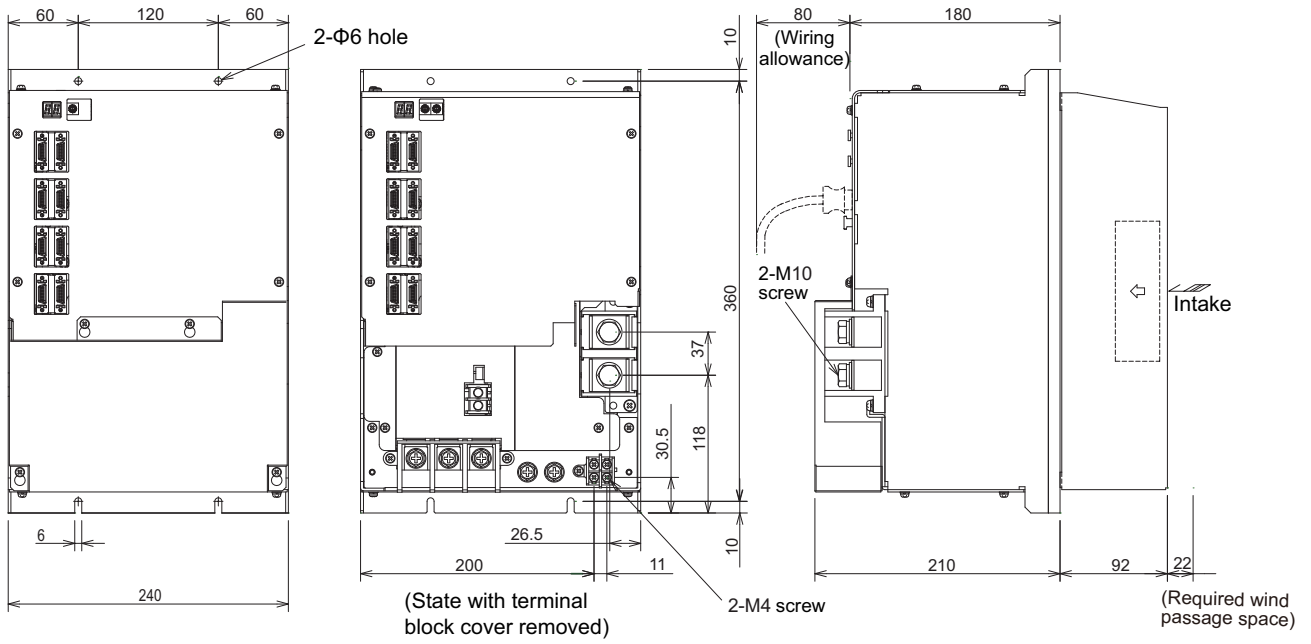

2 Specifications

(7) 300 width

MDS-C1-SP-450-N/NA
MDS-C1-SP-550-N/NA

[Unit: mm]

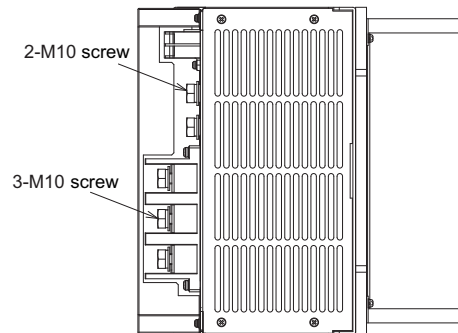
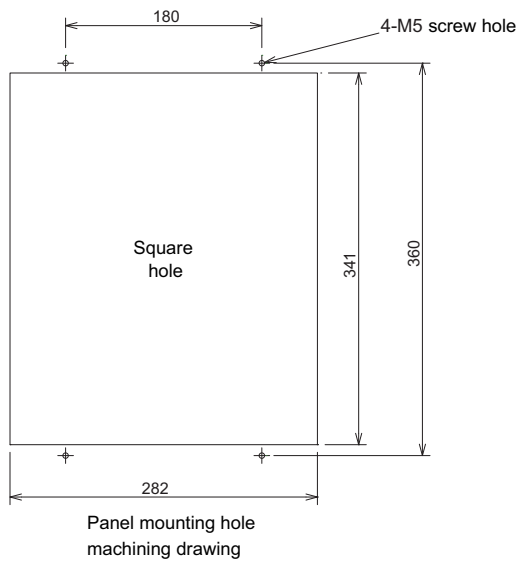
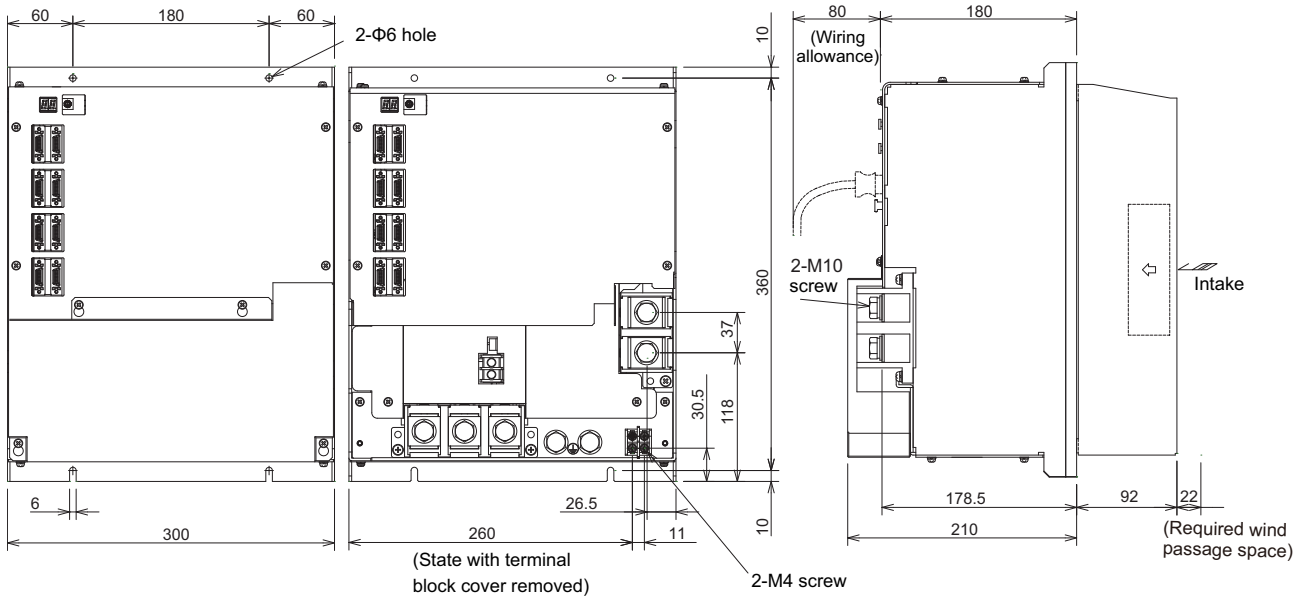

(8) 60 width

MDS-C1-CV-37-N
MDS-C1-CV-75-N

[Unit: mm]

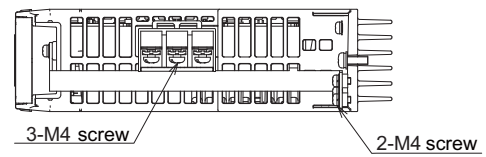
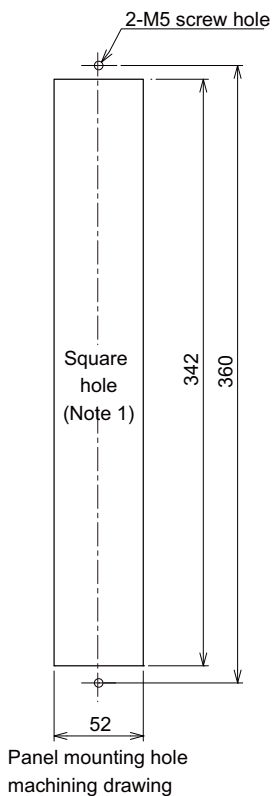
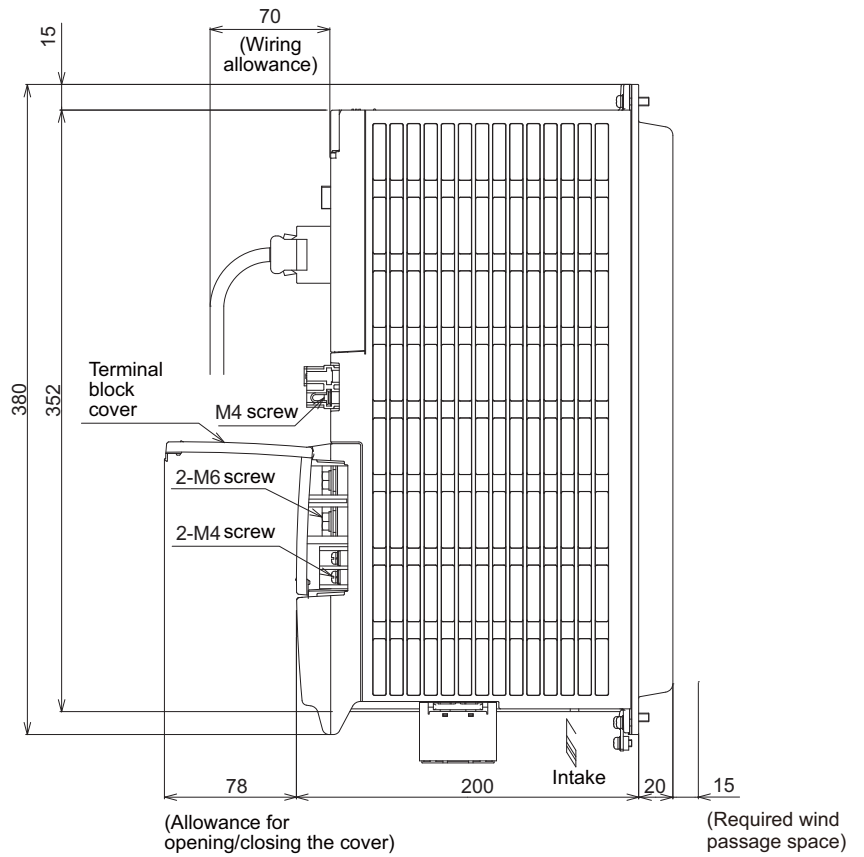
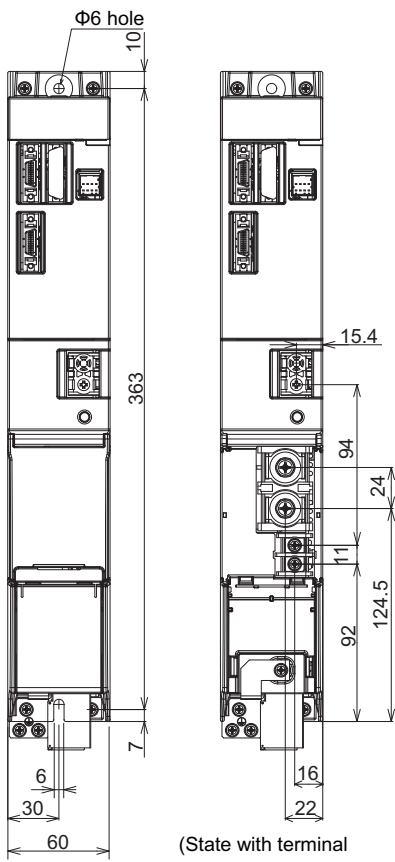

(Note 1) Attach packing around the square hole for sealing.

2 Specifications

(9) 90 width

MDS-C1-CV-110-N

[Unit: mm]

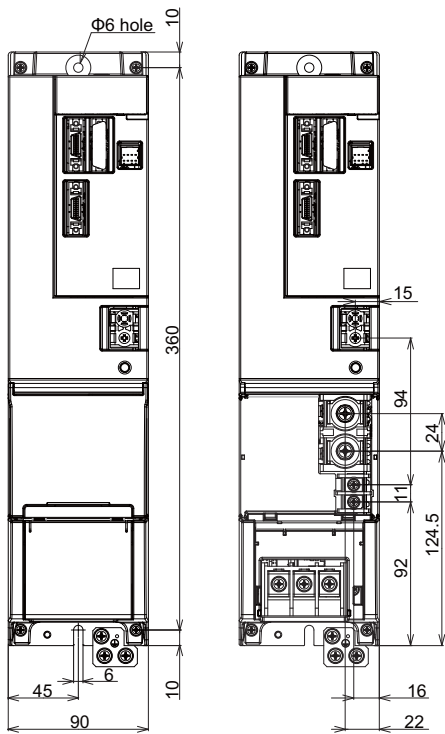

(State with terminal block cover open)

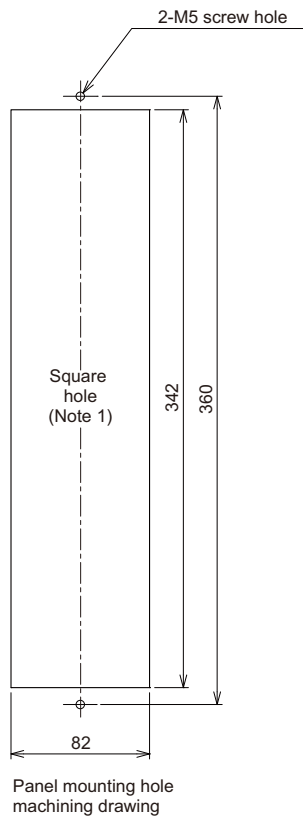
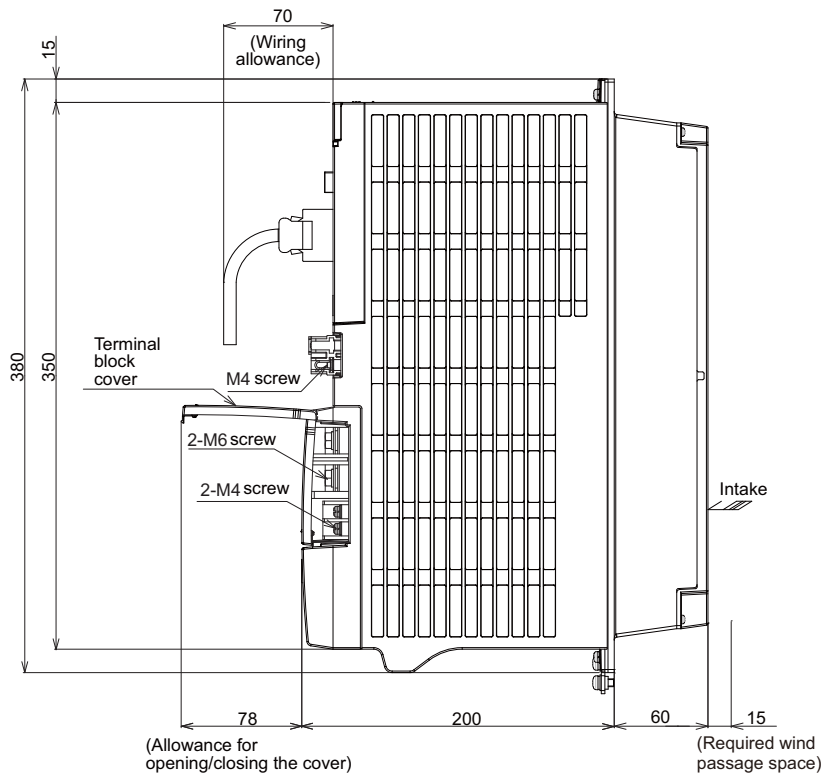

(Note 1) Attach packing around the square hole for sealing.

(10) 120 width

MDS-C1-CV-185-N

[Unit: mm]

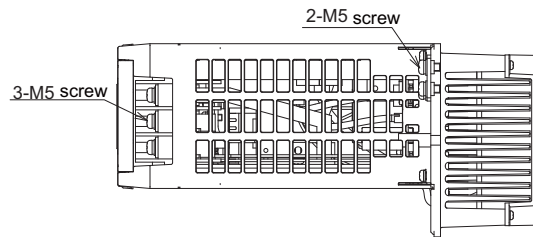
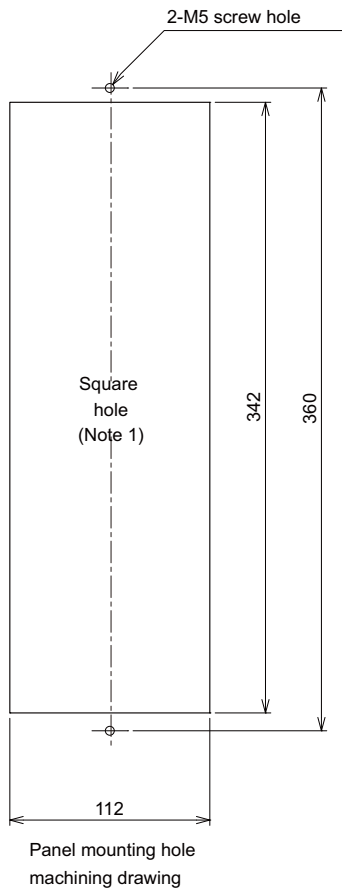
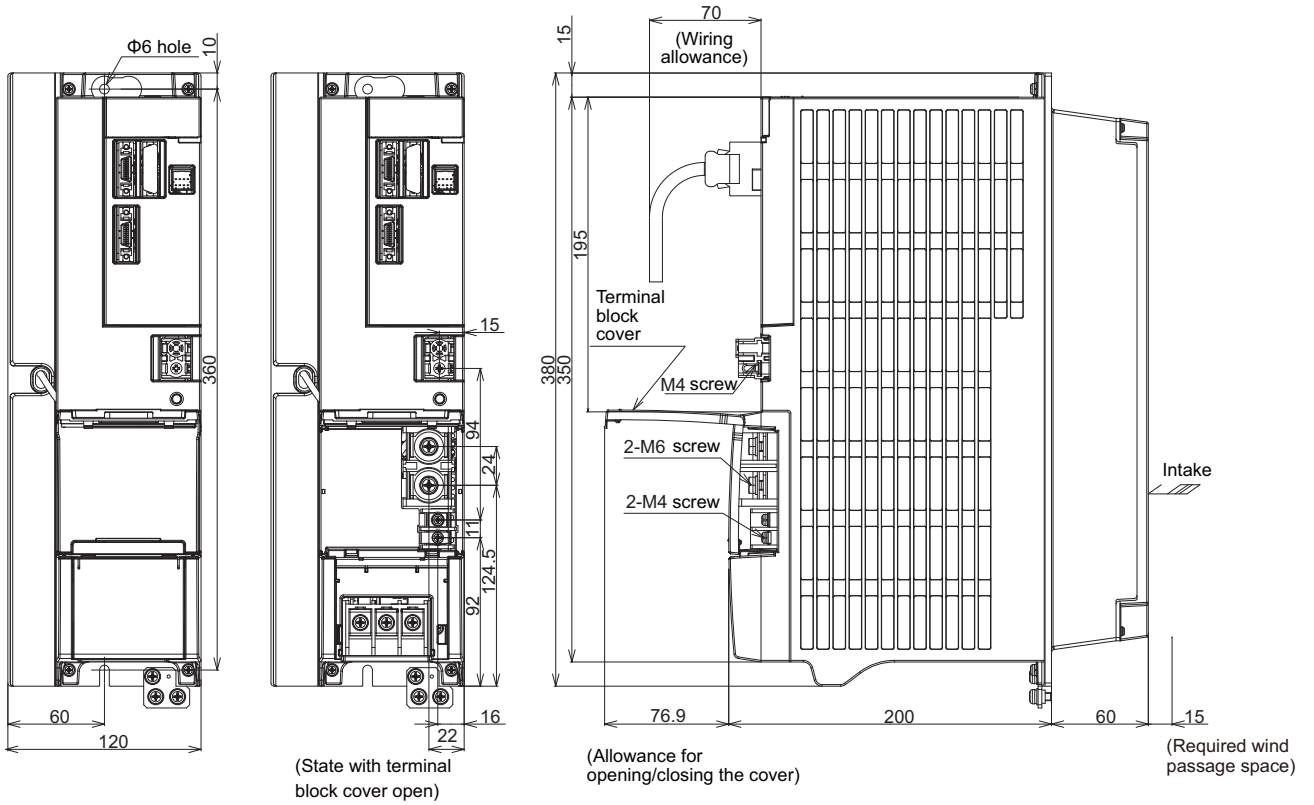

(Note 1) Attach packing around the square hole for sealing.

2 Specifications

(11) 150 width

MDS-C1-CV-300-N
MDS-C1-CV-370-N

[Unit: mm]

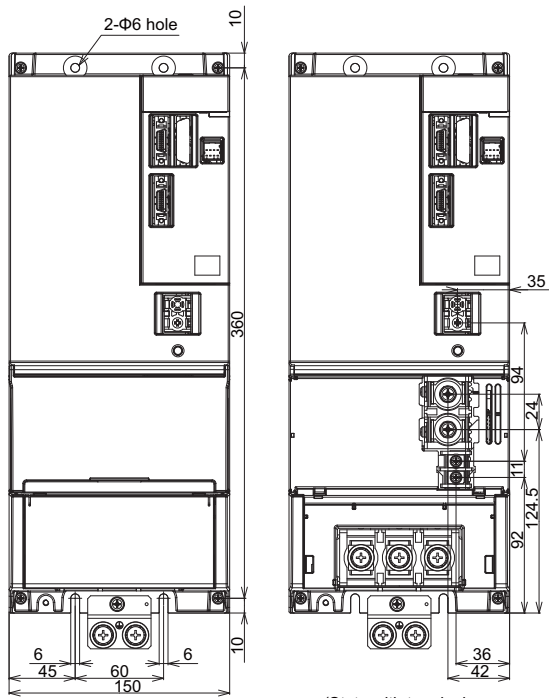

(State with terminal block cover open)

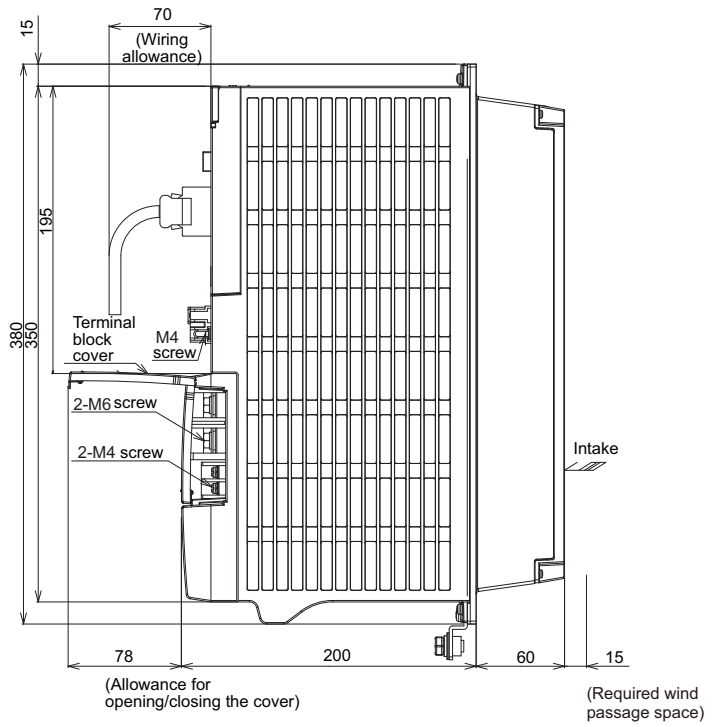

(Allowance for opening/closing the cover)

(Required wind passage space)

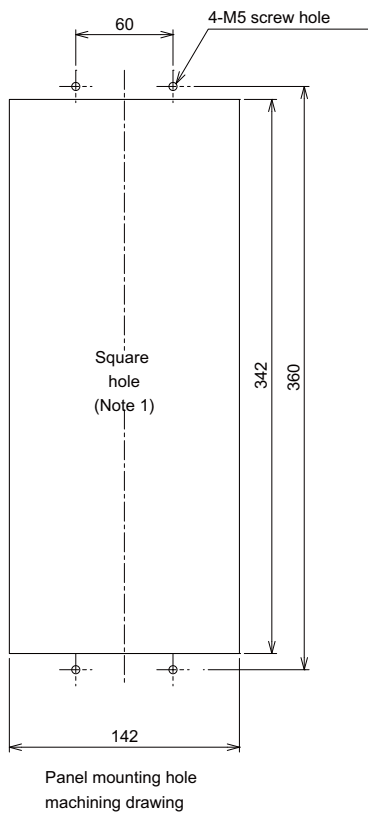

Panel mounting hole machining drawing

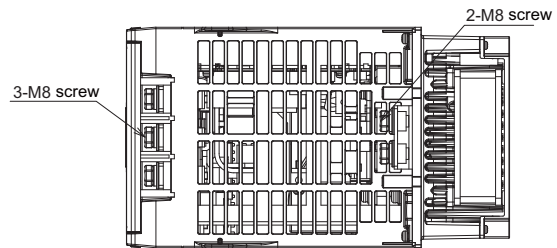

(Note 1) Attach packing around the square hole for sealing.

2.1.8 AC Reactor Outline Dimension Drawing

[Unit: mm]

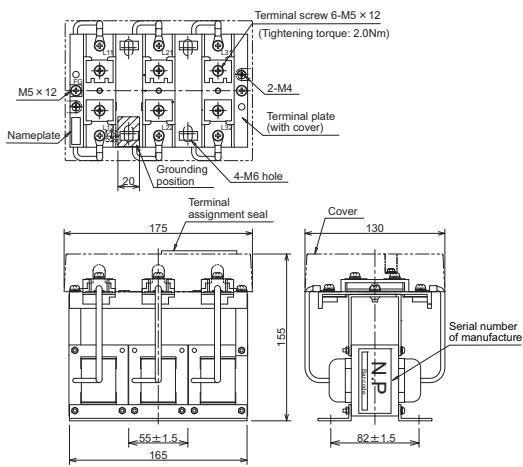

D-AL-7.5K

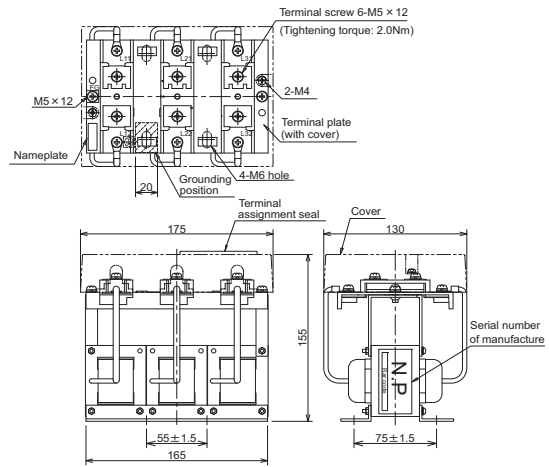

D-AL-11K

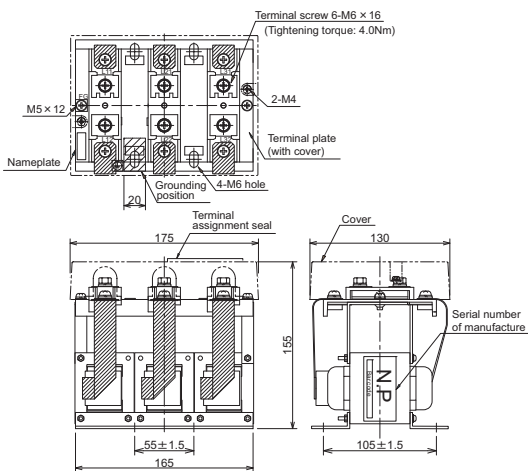

D-AL-18.5K

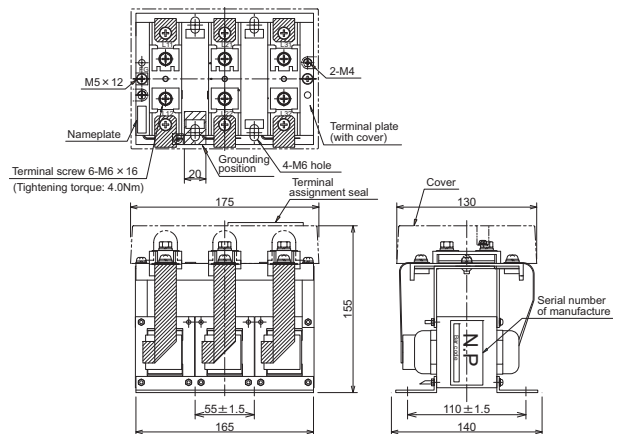

D-AL-30K

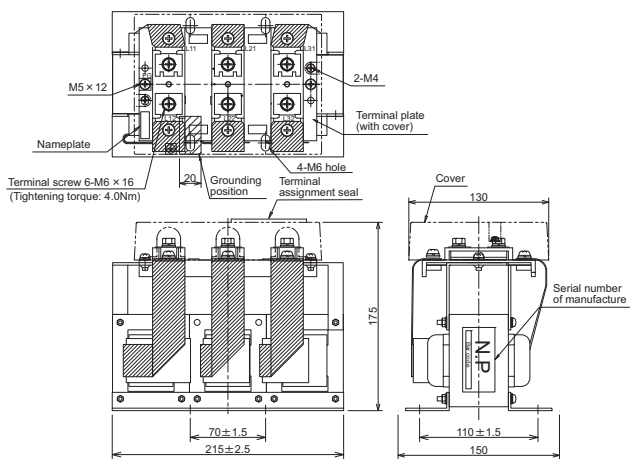

D-AL-37K

2.1.9 Explanation of Each Part

(1) 200V series

(a) Explanation of each servo drive unit part

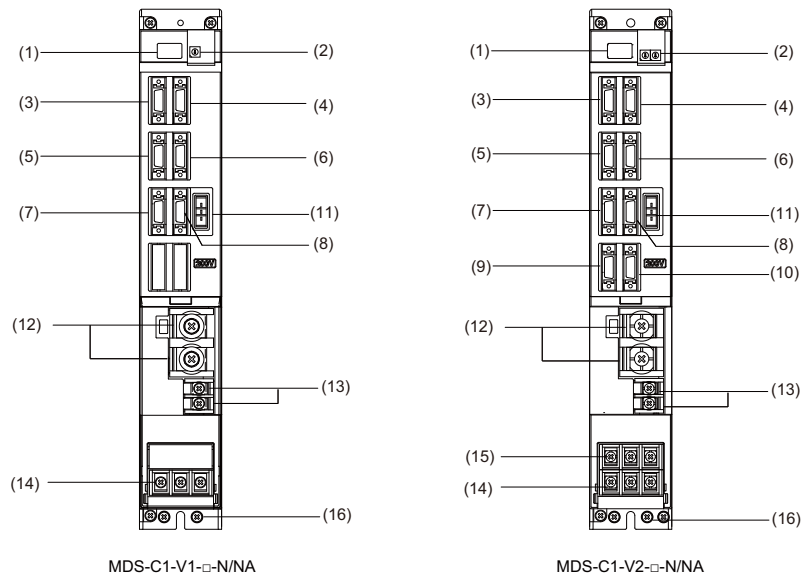

The connector and terminal block layout may differ according to the unit being used. Refer to each unit outline drawing for details.

< Each part name >

		Name		Description
(1)	Control circuit	LED	---	Unit status indication LED
(2)		SW1	---	Axis No. setting switch (Left: L axis, Right: M axis)
(3)		CN1A	---	NC or upward axis communication connector
(4)		CN1B	---	Battery unit/Terminator/Lower axis communication connector
(5)		CN9	---	Analog output connector
(6)		CN4	---	Power supply communication connector
(7)		CN2L	---	Motor side encoder connection connector (L axis)
(8)		CN3L	---	Machine side encoder connection connector (L axis)
(9)		CN2M	---	Motor side encoder connection connector (M axis)
(10)		CN3M	---	Machine side encoder connection connector (M axis)
(11)		CN20	---	Motor brake/dynamic brake control connector (for V1-110/150)
(12)	Main circuit	TE2	L+ L-	Converter voltage input terminal (DC input)
(13)		TE3	L11 L21	Control power input terminal (single-phase AC input)
(14)		TE1	LU, LV, LW	Motor power output terminal (3-phase AC output)
(15)			MU, MV, MW	
(16)	PE	⊕	Grounding terminal	

(Note) The connector names differ for the V1 drive unit. The CN2L/CN3L are named CN2/CN3, and LU, LV and LW terminals are named U, V and W.

< Screw size >

Type	1-axis servo drive unit MDS-C1-V1-				2-axis servo drive unit MDS-C1-V2-			
	01 to 35, 45S	45, 70S	70 to 90	110 to 150	0101 to 2020 3510S, 3520S	3510 to 4545S, 7070S	4545 to 7045	7070
Unit width (mm)	60	90	120	150	60	90	120	150
(12) L+, L-	M6×14							
(13) L11, L21	M4×10							
(14) LU, LV, LW (15) MU, MV, MW	M4×12 (Note)	M5×12		M8×14	M4×12			
(16) ⊕	M4×8	M5×12		M8×14	M4×8			

(Note) The V1-45S UVW terminal screw size is M5, the same as V1-45.

(b) Explanation of each spindle drive unit part

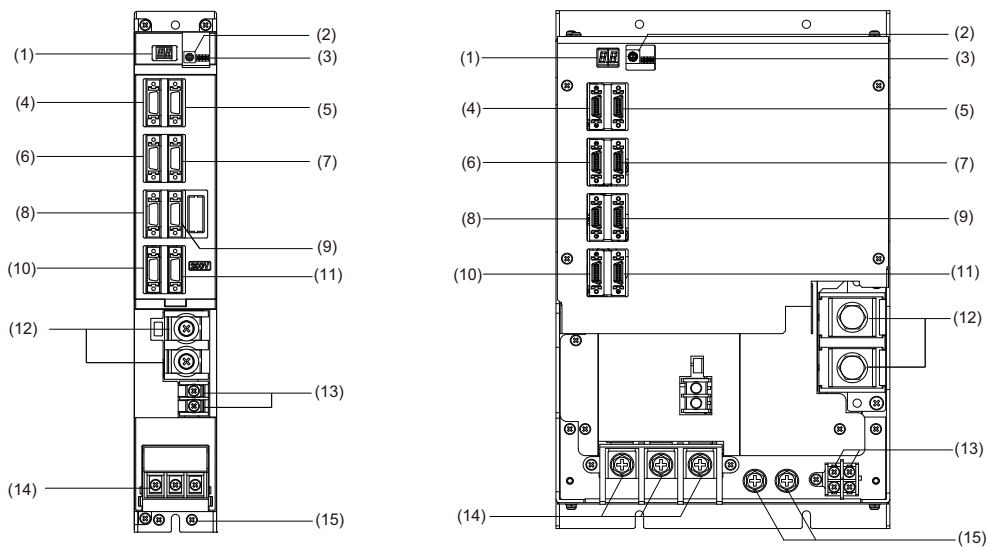

MDS-C1-SP-□-N/NA

The connector and terminal block layout may differ according to the unit being used. Refer to each unit outline drawing for details.

< Each part name >

		Name		Description
(1)	Control circuit	LED	---	Unit status indication LED
(2)		SW1	---	Axis No. setting switch
(3)		SW2	---	Model selection setting switch
(4)		CN1A	---	NC or upward axis communication connector
(5)		CN1B	---	Battery unit/Terminator/Lower axis communication connector
(6)		CN9	---	Analog output connector
(7)		CN4	---	Power supply communication connector
(8)		CN5	---	Internal PLG encoder connection connector
(9)		CN6	---	Magnetic sensor connection connector
(10)		CN7	---	C axis control encoder connection connector (Motor side encoder connection connector)
(11)		CN8	---	CNC connection connector
(12)	Main circuit	TE2	L+ L-	Converter voltage input terminal (DC input)
(13)		TE3	L11 L21	Control power input terminal (single-phase AC input)
(14)		TE1	LU, LV, LW	Motor power output terminal (3-phase AC output)
(15)		PE	⊕	Grounding terminal

< Screw size >

Spindle drive unit MDS-C1-SP-								
Type	04, 075, 15 22, 37	55, 75, 110	150S	150, 185	220, 260U, 300U	260, 300	370	450, 550
Unit width (mm)	60	90	90	120	150	150	240	300
(12) L+, L-	M6×16						M10×20	
(13) L11, L21	M4×12						M4×10	
(14) LU, LV, LW	M4×12	M5×12			M8×16		M8×15	M10×20
(15) ⊕	M4×8	M5×8			M8×14		M8×16	M10×20

(c) Explanation of each power supply unit part

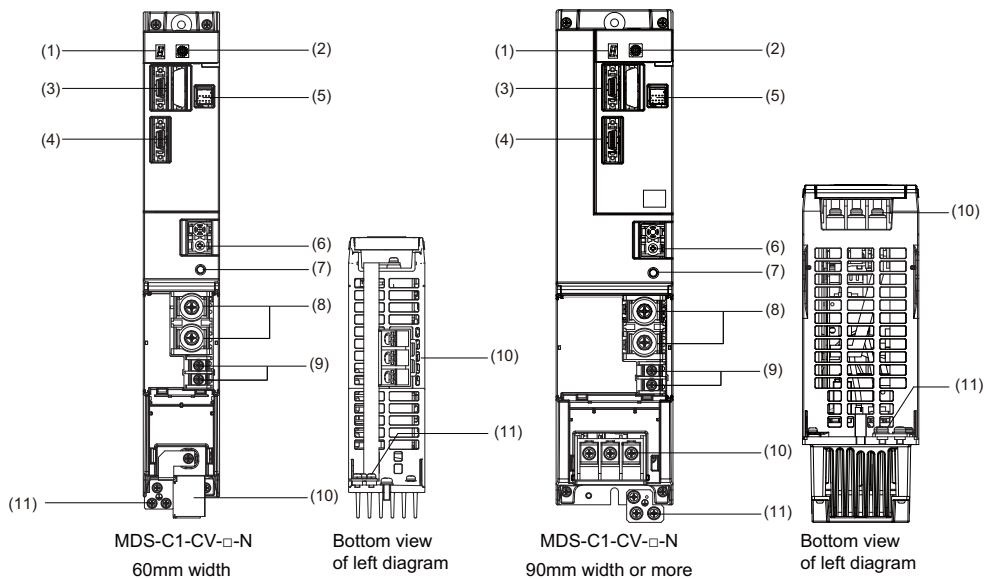

The connector and terminal block layout may differ according to the unit being used. Refer to each unit outline drawing for details.

< Each part name >

		Name		Description
(1)	Control circuit	LED	---	Power supply status indication LED
(2)		SW1	---	Power supply setting switch
(3)		CN4	---	Servo/spindle communication connector (primary)
(4)		CN9	---	Servo/spindle communication connector (secondary)
(5)		CN23	---	External emergency stop input connector
(6)	Main circuit	MC1	---	External contactor control terminal
(7)		---	CHARGE	TE2 output charging/discharging circuit indication LED
(8)		TE2	L+ L-	Converter voltage output terminal (DC output)
(9)		TE3	L11 L21	Control power input terminal (single-phase AC input)
(10)		TE1	L1, L2, L3	Power input connector (3-phase AC input) (For 60mm width) Use a terminal adapter on the wiring side.
				Power input terminal (3-phase AC input) (For 90mm width or more)
(11)		PE	⊕	Grounding terminal

< Screw size >

Type	Power supply unit MDS-C1-CV-					
	37	75	110	185	300	370
Unit width (mm)	60		90	120	150	
(8) L+, L-	M6×18					
(9) L11, L21	M4×10					
(10) L1, L2, L3	M4×10 (Dedicated adapter)		M5×12		M8×16	
(11) ⊕	M4×8		M5×10		M8×14	

2.1.10 Setting DIP Switch

As for spindle drive unit, setting the DIP switches is necessary prior to turning ON the power depending on the target model. Setting of the DIP switches at the time of turning ON the power is validated. Set the model to be used before turning ON the power. All the switches of the DIP switches are OFF at the initial setting.

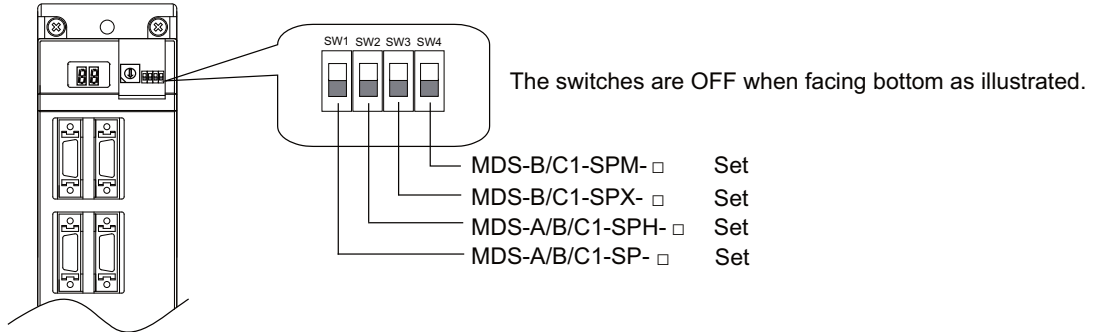

< Set list >

	SW1	SW2	SW3	SW4	Replacement target model
	ON	OFF	OFF	OFF	MDS-A/B/C1-SP-
	OFF	ON	OFF	OFF	MDS-A/B/C1-SPH-
	OFF	OFF	ON	OFF	MDS-B/C1-SPX
	OFF	OFF	OFF	ON	MDS-B/C1-SPM-

(Note) All the other settings lead to Alarm 7F (Power reboot request).

2 Specifications

< Combination of the replacement target model >

Setting of the DIP switches differs depending on the replacement target model.

Set them according to the target model and the operation conditions.

Replacement target	Spindle motor	Application			
		SW1 (C1-SP- □ -N/NA)	SW2 (C1-SPH- □ -N/NA)	SW3 (C1-SPX- □ -N/NA)	SW4 (C1-SPM- □ -N/NA)
SP	IM motor	Usable	Not usable	Not usable (Alarm No.: 37) (Alarm No.: 89) ^{Note 2}	Not usable (Alarm No.: 7F)
SPH	IM motor	Not usable	Usable	Not usable (Alarm No.: 37) (Alarm No.: 89) ^{Note 2}	Not usable (Alarm No.: 7F)
SPX (SPHX)	IM motor (PJEX is connected) ^{Note 1}	Not usable (Alarm No.: 21)	Not usable (Alarm No.: 21)	Usable	Not usable (Alarm No.: 7F)
SPM	IPM motor	Not usable (Alarm No.: 7F)	Not usable (Alarm No.: 7F)	Not usable (Alarm No.: 7F)	Usable

(Note 1) Do not set the switches of the unit for which PJEX is not used.

(Note 2) The alarm differs depending on the SP037 (SFNC5) setting.

SP037: bit0=1 (Encoder orientation valid) ... Alarm No.: 89

SP037: bit2=1 (PLG orientation valid)... Alarm No.: 37

< Details of alarm No. >

Investigation details for the DIP switch setting are added to the following alarms.

Alarm No. 21	Machine side encoder: No signal 2: Spindle: The encoder no-signal was detected.				
Alarm No. 37	Initial parameter error: An incorrect parameter was detected among the parameters received from the CNC at the power ON. "S02 Initial parameter error ####" appears on the NC screen. (####: Error parameter No.)				
Alarm No. 7F	Power reboot request: A mismatch in the program mode selection was detected. Turn the drive unit power ON again.				
Alarm No. 89	Encoder converter unit 2 connection error: Initial communication with the MDS-B-PJEX was not possible.				
	Investigation details	Investigation results	Remedies	SV	SP
	Check the used model setting of the DIP switches.	The used model setting of the DIP switches and the parameter are mismatched.	Check the used model setting of the DIP switches.		○

2.1.11 Setting the Rotary Switch

Set the same rotary switch settings as the unit being replaced.

(Note) When replacing MDS-A-CV, set to "External emergency stop setting not used".

< Setting list >

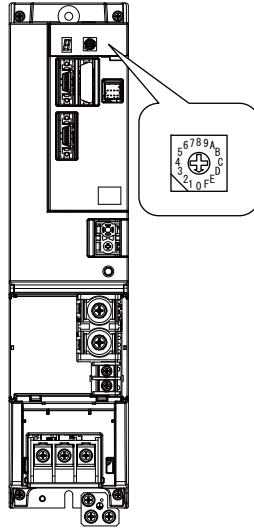

Rotary switch setting	Setting items	
0	Operation with contactor (Detect contactor weld)	External emergency stop setting not used
1	Operation without contactor	
2 to 3	Setting prohibited	
4	Operation with contactor (Detect contactor weld)	External emergency stop setting used (CN23)
5	Operation without contactor	
6 to F	Setting prohibited	

Characteristics

3.1 Drive Unit

3.1.1 Environmental Conditions

Environment	Conditions
Ambient temperature	0°C to +55°C (with no freezing)
Ambient humidity	90% RH or less (with no dew condensation)
Storage temperature	-15°C to +70°C (with no freezing)
Storage humidity	90% RH or less (with no dew condensation)
Atmosphere	Indoors (no direct sunlight); no corrosive gas, inflammable gas, oil mist, dust or conductive fine particles
Altitude	Operation/storage: 1000m or less above sea level Transportation: 10000m or less above sea level
Vibration	Operation/storage: 4.9m/s ² (0.5G) or less Transportation: 49m/s ² (5G) or less

(Note) When installing the machine at 1,000m or more above sea level, the heat dissipation characteristics will drop as the altitude increases in proportion to the air density. The ambient temperature drops 1% with every 100m increase in altitude.

When installing the machine at 1,800m altitude, the heating value of the drive unit must be reduced to 92% or less. The heating value is proportional to the square of the current, and required current decreasing rate follows the expression below.

$$\text{Required current decreasing rate} = \sqrt{0.92} = 0.95$$

Therefore, use the unit with the reduced effective load rate to 95% or less.

3.1.2 Heating Value

Each heating value is calculated with the following values.

The values for the servo drive unit apply at the stall output. The values for the spindle drive unit apply for the continuous rated output. The values for the power supply unit include the AC reactor's heating value.

Type MDS-C1- □ -N/NA	Servo drive unit		Type MDS-C1- □ -N/NA	Spindle drive unit		Type MDS-C1- □ -N	Power supply unit				
	Heating value [W]			Heating value [W]			Heating value [W]				
	Inside panel	Outside panel		Inside panel	Outside panel		Inside panel	Outside panel			
V1-01	21	0	V2-0101	38	0	SP-04	30	0	CV-37	20	34
V1-03	27	0	V2-0301	41	0	SP-075	40	0	CV-75	24	55
V1-05	37	0	V2-0303	43	0	SP-15	49	0	CV-110	25	99
V1-10	53	0	V2-0501	46	0	SP-22	26	42	CV-185	32	161
V1-20	25	66	V2-0503	52	0	SP-37	28	51	CV-300	45	272
V1-35	30	102	V2-0505	62	0	SP-55	31	76	CV-370	53	343
V1-45S	34	124	V2-1005	78	0	SP-75	35	102			
V1-45	37	148	V2-1010	96	0	SP-110	41	140			
V1-70S	38	151	V2-2010	37	117	SP-150S	48	140			
V1-70	50	234	V2-2020	41	137	SP-150	48	187			
V1-90	56	275	V2-3510S	44	146	SP-185	62	280			
V1-110	74	392	V2-3510	42	148	SP-220	65	301			
V1-150	96	545	V2-3520S	48	165	SP-260	80	403			
			V2-3520	45	168	SP-260U	80	403			
			V2-3535	51	209	SP-300	98	522			
			V2-4520	52	214	SP-300U	98	522			
			V2-4535	57	249	SP-370	243	607			
			V2-4545S	55	225	SP-450	280	720			
			V2-4545	64	295	SP-550	330	870			
			V2-7035	70	336						
			V2-7045	77	382						
			V2-7070S	65	300						
			V2-7070	90	468						
			V2-9090S	65	300						

- (Note 1) The values for the spindle drive unit are the heating value at the continuous rated output, and the values for the servo drive unit are the heating values at the stall output when operating in the high-gain mode. The heating value when operating the servo drive unit in the standard mode (MDS-B compatible mode) is lower than the MDS-B Series heating value. However, with the new design, the standard operation mode will not presumably be used, so the data has been eliminated.
- (Note 2) The total heating value for the unit is the total sum of the heating values for the above corresponding units which are mounted in the actual machine.
- (Note 3) When designing the panel for sealed mounting, take the actual load rate into consideration, and calculate the heating value inside the servo drive unit panel with the following expression:

$$\text{Heating value inside servo drive unit panel (considering load rate)} = \text{Heating value in panel obtained from above table} \times 0.5$$

If the load rate is clearly larger than 0.5, substitute that load rate for ($\times 0.5$) in the above expression.

Example) When the V1-35 servo drive unit is mounted

Heating value in panel (at rated output) = 30(W)

Thus, the heating value in the panel (considering the load rate) is $30 \times 0.5 = 15$ (W)

4

Dedicated Options

4.1 Drive Unit

4.1.1 Dynamic Brake Unit (MDS-B-DBU)

The MDS-C1-V1-110 and MDS-C1-V1-150 units do not have dynamic brakes built in, so install an external dynamic brake unit.

(1) Specifications

Type	Coil specifications	Compatible drive unit	Weight
MDS-B-DBU-150	DC24V 160mA	MDS-C1-V1-110/150	2kg

(2) Outline dimension drawings

MDS-B-DBU-150

[Unit:mm]

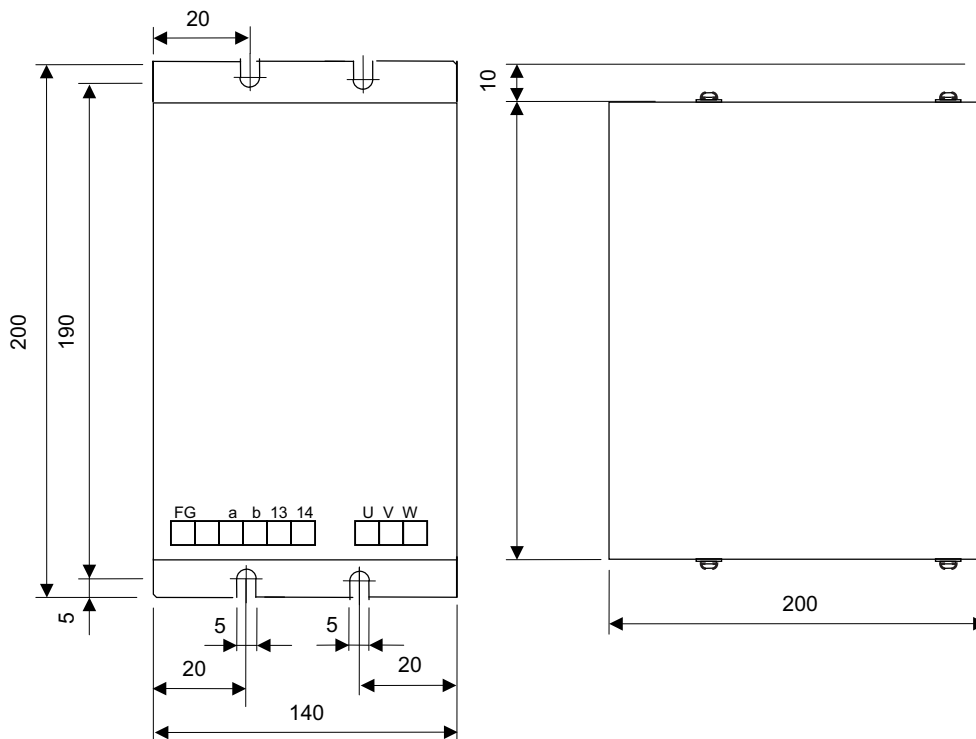

(3) Connecting with the servo drive unit

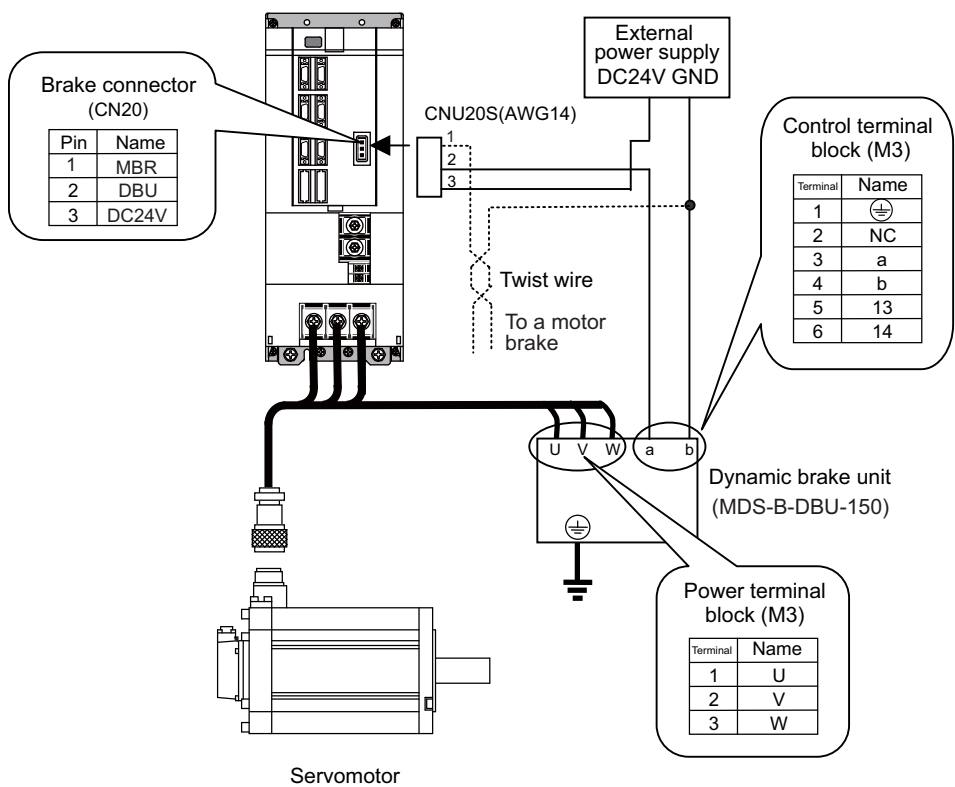

Internal circuit diagram

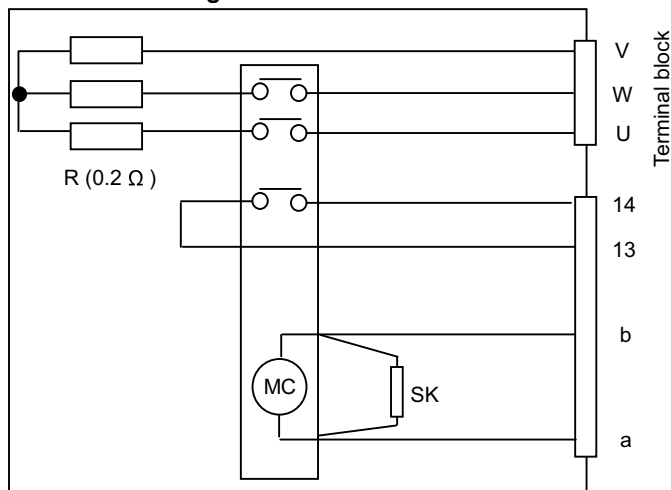

CAUTION

Correctly wire the dynamic brake unit to the servo drive unit.
Do not use for applications other than emergencies (normal braking, etc.). The internal resistor could heat up, and lead to fires or faults.

POINT

When you use a motor with a brake, please wire (between 1pin and 3pin) for the CN20 connector.

4.1.2 Dedicated Adapter for Main Circuit Power Supply (CNU01SC1NCV)

(1) Specifications list

Name	Type	Details
TE1	Power supply adapter for MDS-C1-CV-37-N and MDS-C1-CV-75-N	CNU01SC1NCV
		HTM0FS030001C

(2) Outline dimension drawings

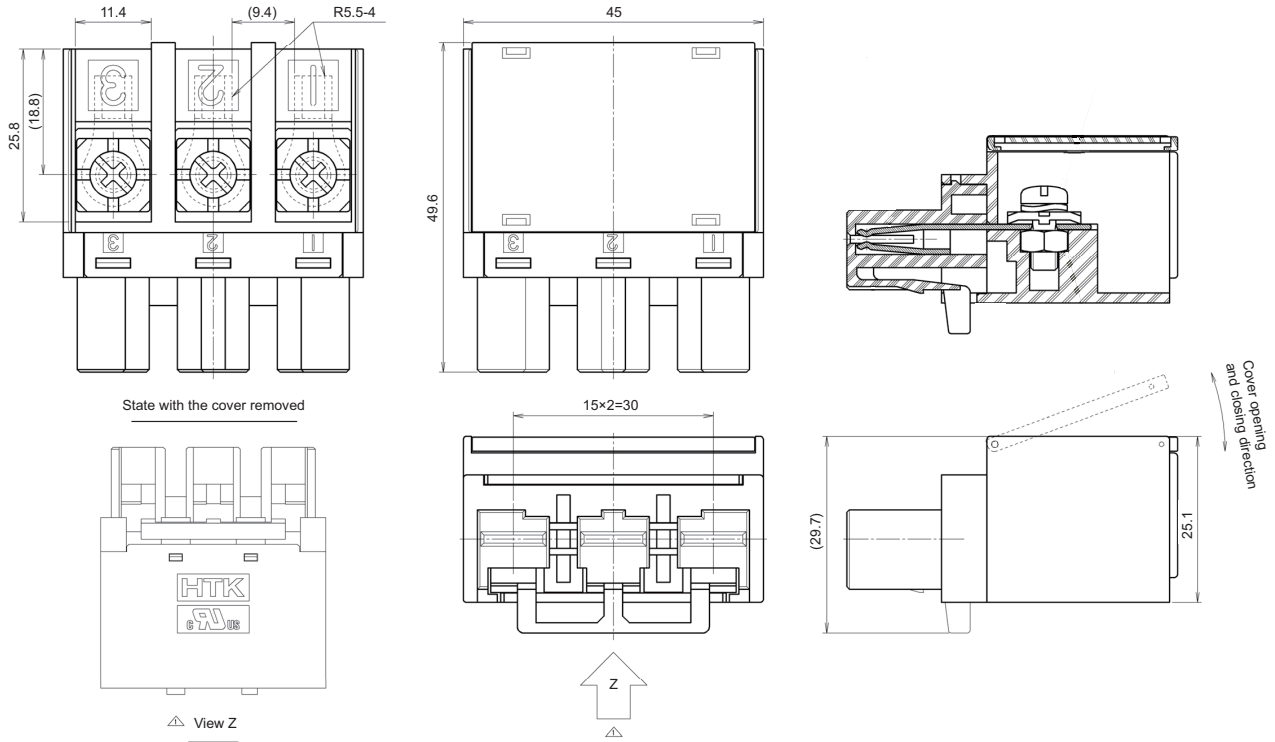

4.1.3 MC Extension Kit (MC-SET)

The MC1 terminal block position is changed. Use this kit when the wire is not long enough.

(1) Specifications list

	Name	Type	Details
MC1	MDS-C1-CV-N MC extension kit	MC-SET	Cable (AWG14) Insulation cap (VCC-1-09) Cable tie (T18R-V0) Screw + nut

(2) Outline dimension drawings

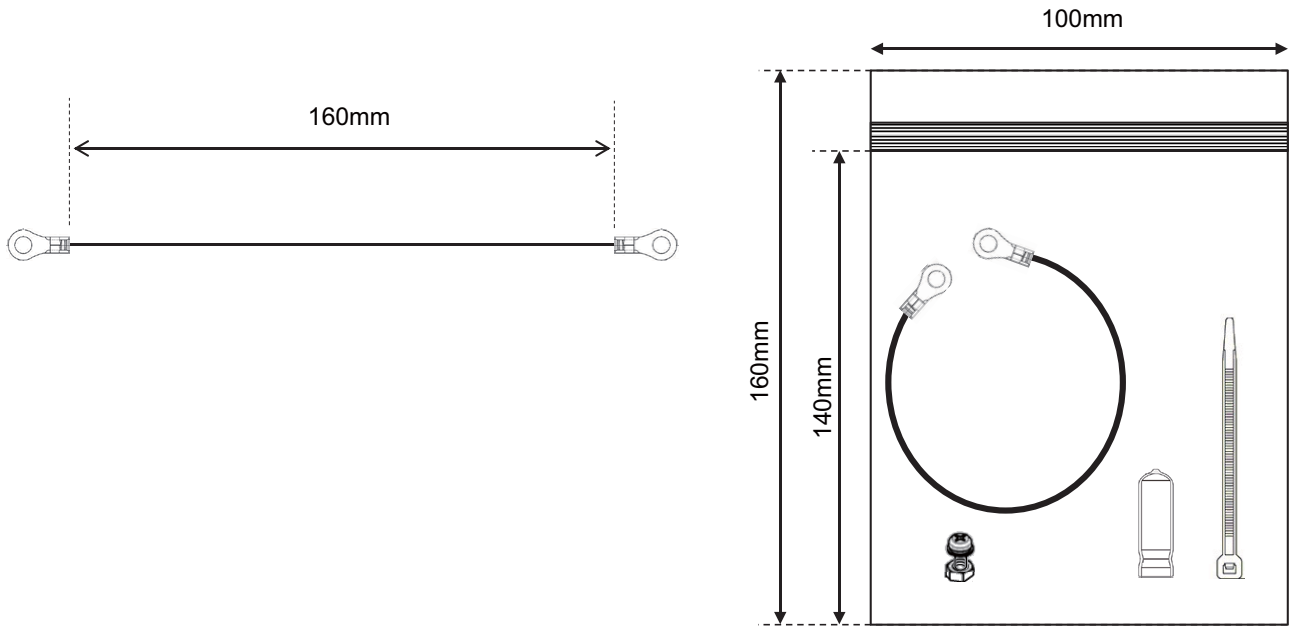

4.1.4 External Emergency Stop Conversion Cable

(1) Specifications list

Name		Type	Details	
CN23	MDS-C1-CV-N External emergency stop conversion cable	CN23-EMG	Current connector side (Tyco Electronics) Connector: 177648-3 Contact: 175288-2	Power supply side (Tyco Electronics) Connector: 1-1318119-4 Contact: 1318108-1



(2) Outline dimension drawings

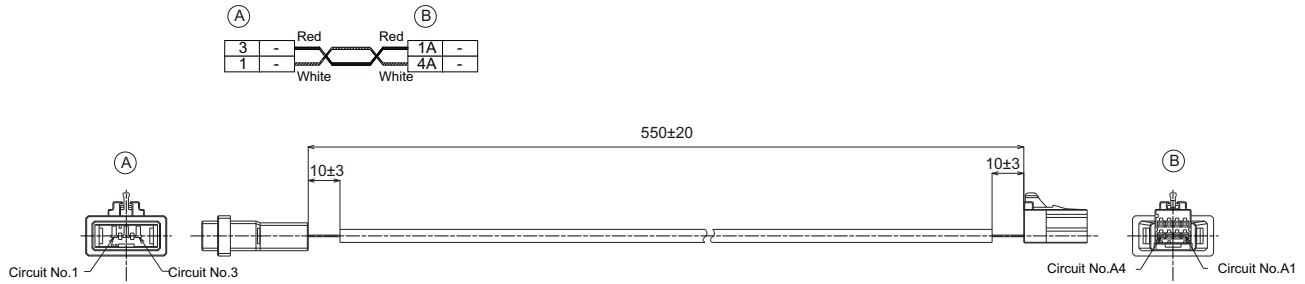

5

Troubleshooting

5.1 LED Display When Alarm or Warning Occurs

Power supply unit

The alarm/warning No. is alternately displayed by one digit. Refer to section "List of alarms" and "List of warnings" for details. The display flickers when an alarm or a warning occurs.

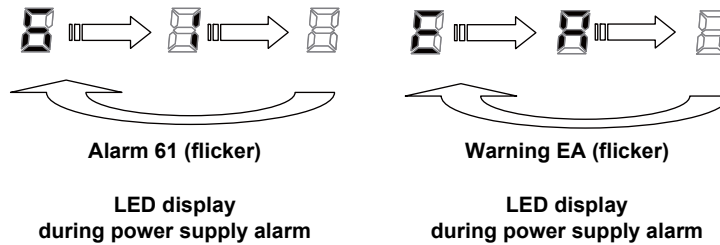

Numbers displayed on LED

No.	0	1	2	3	4	5	6	7	8	9	A	B	C	D	E	F
LED display	0	1	2	3	4	5	6	7	8	9	A	b	c	d	E	F

List of alarms/warnings specifications

< List of alarms >

No.	Name	Details	Reset method
61	Power module overcurrent	Overcurrent protection function in the power module has started its operation.	PR
62	Frequency error	The input power supply frequency increased above the specification range. (Note 1)	PR
66	Process error	An error occurred in the process cycle.	PR
67	Phase interruption	An open-phase condition was detected in input power supply circuit.	PR
68	Watchdog	The system does not operate correctly.	AR
69	Grounding	The motor power cable is in contact with FG (Frame Ground).	NR
6A	External contactor welding	A contact of the external contactor is welding. (Note 1)	PR
6B	Rush circuit error	An error was detected in the rush circuit.	PR
6C	Main circuit error	An error was detected in charging operation of the main circuit capacitor.	PR
6E	Memory error	An error was detected in the internal memory.	AR
6F	Power supply error	No power supply is connected to the drive unit, or an error was detected in the power supply's A/D converter.	AR
70	External emergency stop error	A mismatch of the external emergency stop input and NC emergency stop input continued for 30 seconds.	PR
71	Instantaneous power interruption	The power was momentarily interrupted.	NR
73	Over regeneration	Over-regeneration detection level became over 100%. The regenerative resistor is overloaded.	NR
75	Overvoltage	The main circuit PN bus voltage exceeded the tolerable value.	NR
76	External emergency stop setting error	The rotary switch setting for the external emergency stop does not match the parameter setting.	AR
77	Power module overheat	Thermal protection function in the power module has started its operation.	PR

(Note 1)The alarm detection period for Alarm 62 and 6A is different from MDS-A/B Series. (C1-CV-N: The alarms are detected during READY ON.)









< List of warnings >

No.	Name	Details	Reset method
E9	Instantaneous power interruption warning	The power was momentarily interrupted.	NR
EA	In external emergency stop state	External emergency stop signal was input.	*
EB	Over regeneration warning	Over-regeneration detection level exceeded 80%.	*







< List of alarm displays >

No.	Name	MDS-A/B/C1 Series	MDS-C1-CV-N Series
61	Power module overcurrent	1	6 → 1
62	Frequency error	2	6 → 2
66	Process error	6	6 → 6
67	Phase interruption	7	6 → 7
68	Watchdog	8	6 → 8
69	Grounding	9	6 → 9
6A	External contactor welding	A	6 → A
6B	Rush circuit error (Rush relay melted)	b	6 → b
6C	Main circuit error	c	6 → c
6E	Memory error	E	6 → E
6F	Power supply error	F	6 → F
70	External emergency stop error (Note) MDS-B Series or later	G	7 → 0
71	Instantaneous power interruption	H	7 → 1
73	Over regeneration	J	7 → 3
75	Overvoltage	L	7 → 5
76	External emergency stop setting error	n	7 → 6
77	Power module overheat	n	7 → 7

< List of warning displays >

No.	Name	MDS-A/B/C1 Series	MDS-C1-CV-N Series
E9	Instantaneous power interruption warning		 → 
EA	In external emergency stop state		 → 
EB	Over regeneration warning		 → 

< List of display differences when using CVR mode >

System state	MDS-C1 Series		MDS-C1-CV-N Series	
	CV	CVR	CV	CVR
Unit/NC power ON				
During ready ON command				
During ready ON				

Specifications of Peripheral Devices

6.1 Selection of Wire

Selected wires must be able to tolerate each unit and motor terminal part to which the wire is connected.

How to calculate tolerable current of an insulated wire or cable is shown in "Tolerable current of electric cable" (1) of Japanese Cable Makers' Association Standard (JCS)-168-E (1995), its electric equipment technical standards or JEAC regulates tolerable current, etc. wire.

When exporting wires, select them according to the related standards of the country or area to export.

Wire's tolerable current is different depending on conditions such as its material, structure, ambient temperature, etc.

Check the tolerable current described in the specification of the wire to use.

6.1.1 Example of Wires by Unit

The following are examples of wire selections for each unit based on the certification standards.

The relation between wire size and tolerable current conforms to the requirements specified in IEC/EN60204-1, UL508C.

However, the tolerable current is different depending on the wire specifications of each manufacturer even among the wires of the same size.

(1) 600V vinyl insulated wire (IV wire) 60°C product (Example according to IEC/EN60204-1, UL508C) < MDS-C1-N Series >

Unit type		Terminal name					
		TE1 (L1, L2, L3, ⊕)		TE2 (L+, L-)		TE3, MC1 (L11, L21, L12, L22)	
		mm ²	AWG	mm ²	AWG	mm ²	AWG
Power supply unit	MDS-C1-CV-37-N	3.5	12	3.5	12	2	14
	MDS-C1-CV-75-N	5.5	10	8	8		
	MDS-C1-CV-110-N	14	6	14	6		
	MDS-C1-CV-185-N	-	-	38	2		
	MDS-C1-CV-300-N	-	-	Bar enclosed			
MDS-C1-CV-370-N	-	-	Bar enclosed				

(2) 600V double (heat proof) vinyl insulated wire (HIV wire) 75°C product (Example according to IEC/EN60204-1, UL508C) < MDS-C1-N Series >

Unit type		Terminal name					
		TE1 (L1, L2, L3, ⊕)		TE2 (L+, L-)		TE3, MC1 (L11, L21, L12, L22)	
		mm ²	AWG	mm ²	AWG	mm ²	AWG
Power supply unit	MDS-C1-CV-37-N	2	14	3.5	12	2	14
	MDS-C1-CV-75-N	5.5	10	5.5	10		
	MDS-C1-CV-110-N	8	8	8	8		
	MDS-C1-CV-185-N	22	4	22	4		
	MDS-C1-CV-300-N	38	2	60 or bar enclosed	1/0 or bar enclosed		
	MDS-C1-CV-370-N	60	1/0	Bar enclosed			

Appendix 1

EMC Installation Guidelines

Appendix 1.1 Introduction

As the NC unit is a component designed to control machine tools, it is believed to be out of the direct EMC Instruction subject. However, we would like to introduce the following measure plans to backup EMC Instruction compliance of the machine tool as the NC unit is a major component of the machine tools.

- [1] Methods for installation in control/operation panel
- [2] Methods of wiring cable outside of panel
- [3] Introduction of countermeasure parts

Mitsubishi is carrying out tests to confirm the compliance to the EMC Standards under the environment described in this manual. However, the level of the noise will differ according to the equipment type and layout, control panel structure and wiring lead-in, etc. Thus, we ask that the final noise level be confirmed by the machine tool builder.

For measures for CNC, refer to "EMC INSTALLATION GUIDELINES" of each NC Connection Manual.

Appendix 1.2 EMC Instructions

The EMC Instructions regulate mainly the following two withstand levels.

Emission Capacity to prevent output of obstructive noise that adversely affects external sources.

Immunity Capacity not to malfunction due to obstructive noise from external sources.

The details of each level are classified in the table below. It is assumed that the Standards and test details required for a machine tool are about the same as these.

Class	Name	Details	Generic Standard	Standards for determining test and measurement
Emission	Radiated noise	Electromagnetic noise radiated through the air	EN61000-6-4 (General industrial machine) EN61800-3 (Motor control unit)	-----
	Conductive noise	Electromagnetic noise discharged from power line		
Immunity	Static electricity electrical discharge immunity test	(Example) Withstand level of discharge of electricity charged in a human body.	EN61000-6-2 (General industrial machine) EN61800-3 (Motor control unit)	EN61000-4-2
	Radiated radio-frequency magnetic field immunity test	(Example) Simulation of immunity from digital wireless transmitters		EN61000-4-3
	Electrical fast transient/burst immunity test	(Example) Withstand level of noise from relays or connecting/disconnecting live wires		EN61000-4-4
	Immunity to conducted disturbance induced by radio-frequency magnetic field	(Example) Withstand level of noise entering through power line, etc.		EN61000-4-6
	Power supply frequency field immunity test	(Example) 50/60Hz power frequency noise		EN61000-4-8
	Immunity test for voltage dip, short-time power failure and voltage fluctuation	(Example) Power voltage drop withstand level		EN61000-4-11
	Surge immunity test	(Example) Withstand level of noise caused by lightning		EN61000-4-5

Appendix 1.3 EMC Measures

The main items relating to EMC measures include the following.

- [1] Store the device in an electrically sealed metal panel.
- [2] Earth all conductors that are floating electrically. (Lower the impedance.)
- [3] Wire the power line separated from the signal wire as far as possible.
- [4] Use shielded wires for the cables wired outside of the panel.
- [5] Install a noise filter.

Ensure the following items to suppress noise radiated outside of the panel.

- [1] Accurately ground the devices.
- [2] Clamp shielded wires in the control panel.
- [3] Increase the panel's electrical seal. Reduce the gap and hole size.

Note that the electromagnetic noise radiated in the air is greatly affected by the clearance of the panel and the quality of the cable shield.

Appendix 1.4 Measures for Panel Structure

The design of the panel is a very important factor for the EMC measures, so take the following measures into consideration.

Appendix 1.4.1 Measures for Control Panel Unit

- [1] Use metal for all materials configuring the panel.
- [2] For the joining of the top plate and side plates, etc., mask the contact surface with paint, and fix with welding or screws so that the impedance is reduced. In either case, keep the joining clearance to a max. of 20cm for a better effect.

Note that if the plate warps due to the screw fixing, etc., creating a clearance, noise could leak from that place.

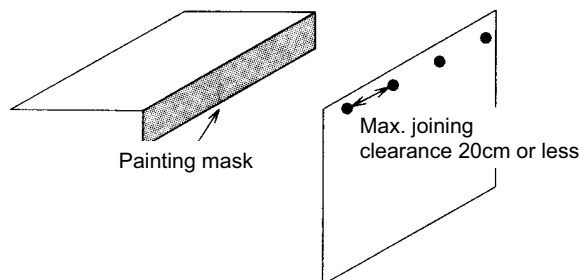

- [3] Plate the earth plate (with nickel, tin), and connect the connections with a low impedance.
- [4] If there is a opening on the panel surface, such as the ventilation holes, cover it with a metal plate or expanded metal.

Make sure not to connect using metal or a conductor without peeling off the surface, which results in an insufficient electrical connection. (ex. connection by putting painted surfaces together)

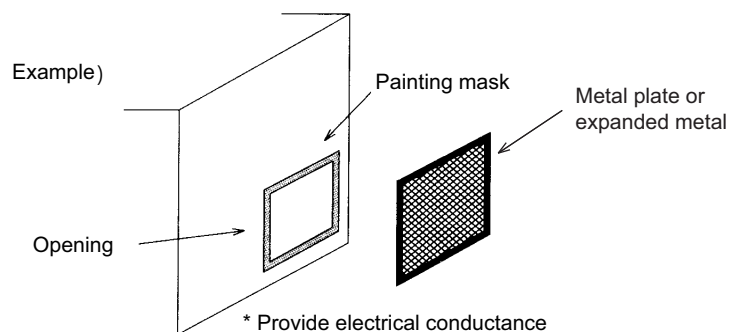

Appendix 1.4.2 Measures for Door

- [1] Use metal for all materials configuring the door.
- [2] Use an EMI gasket or conductive packing for the contact between the door and control panel unit.
- [3] The EMI gasket or conductive packing must contact at a uniform and correct position of the metal surface of the control panel unit.
- [4] The surface of the control panel unit contacted with the EMI gasket or conductive packing must have conductance treatment.
(Example) Weld (or screw) a plate that is plated (with nickel, tin).

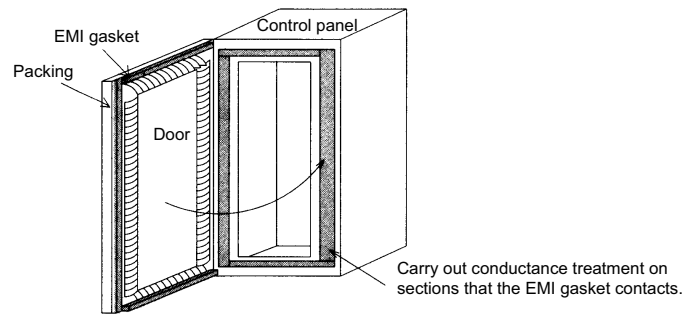

- [5] As a method other than the above, the control panel unit and door can be connected with a plain braided wire. In this case, the panel and door should be contacted at as many points as possible.

Appendix 1.4.3 Measures for Operation Board Panel

- [1] Always connect the operation board and indicator with an earthing wire.
- [2] If the operation board panel has a door, use an EMI gasket or conductive packing between the door and panel to provide electrical conductance in the same manner as the control panel.
- [3] Connect the operation board panel and control panel with a sufficiently thick and short earthing wire.

Appendix 1.4.4 Shielding of the Power Supply Input Section

- [1] Separate the input power supply section from other parts in the control panel so that the input power supply cable will not be contaminated by radiated noise.
- [2] Do not lead the power line through the panel without passing it through a filter.

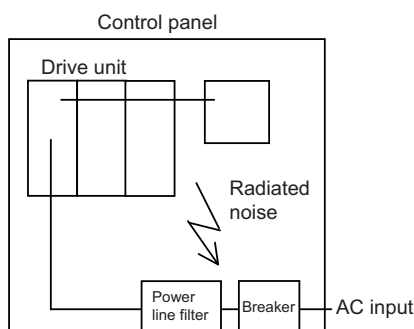

The power supply line noise is eliminated by the filter, but cable contains noise again because of the noise radiated in the control panel.

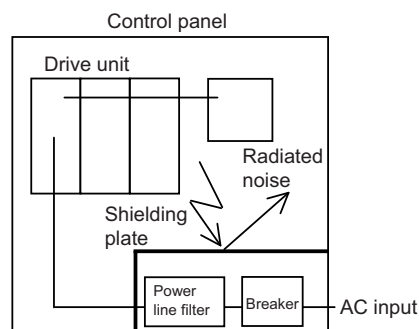

Use a metal plate, etc., for the shielding partition. Make sure not to create a clearance.

Appendix 1.5 Measures for Various Cables

The various cables act as antennas for the noise and discharge the noise externally. Thus appropriate treatment is required to avoid the noise.

The wiring between the drive unit and motor act as an extremely powerful noise source, so apply the following measures.

Appendix 1.5.1 Measures for Wiring in Panel

- [1] If the cables are led unnecessarily in the panel, they will easily pick up the radiated noise. Thus, keep the wiring length as short as possible.

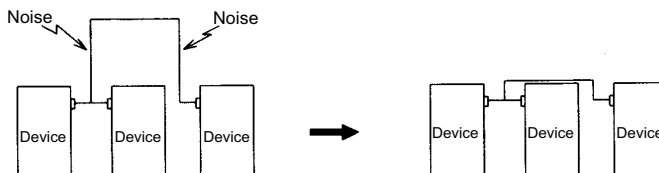

- [2] The noise from other devices will enter the cable and be discharged externally, so avoid internal wiring near the openings.

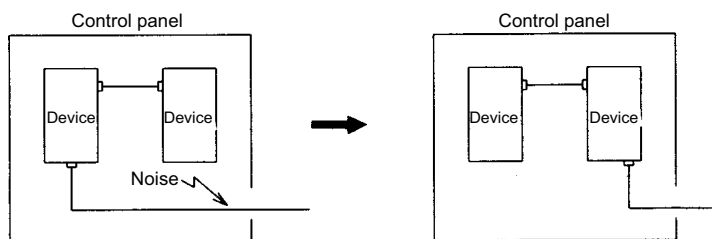

- [3] Connect the control device earthing terminal and earthing plate with a thick wire. Take care to the leading of the wire.

Appendix 1.5.2 Measures for Shield Treatment

Common items

Use of shield clamp fittings is recommended for treating the shields. The fittings are available as options, so order as required. (Refer to the section "Shield Clamp Fitting" in this chapter.)

Clamp the shield at a position within 10cm from the panel lead out port.



POINT

1. When leading the cables, including the grounding wire (FG), outside of the panel, clamp the cables near the panel outlet (recommendation: within 10cm).
2. When using a metal duct or conduit, the cables do not need to be clamped near the panel outlet.
3. When leading cables not having shields outside the panel, follow the instructions given for each cable. (Installation of a ferrite core, etc., may be required.)

Appendix 1.5.3 Servo/Spindle Motor Power Cable

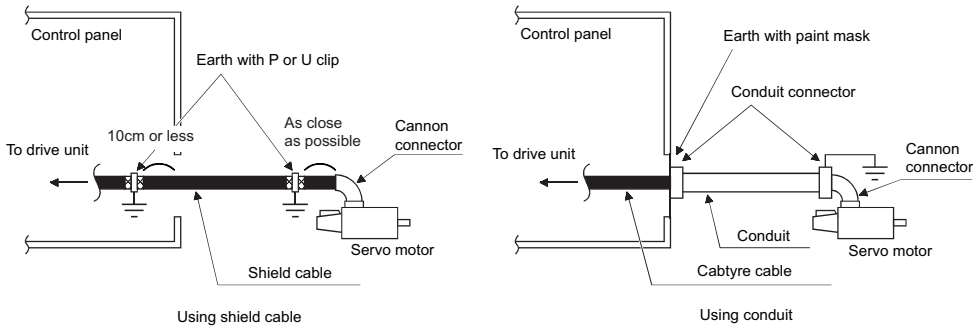

Power cable for servo motor

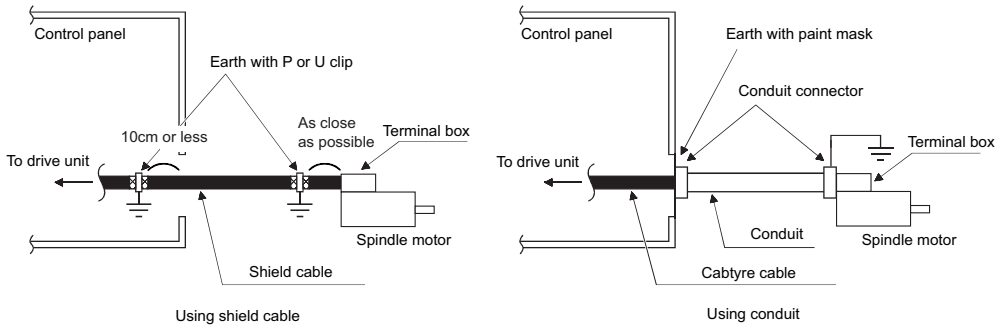

Power cable for spindle motor

- [1] Use four wires (3-phase + earthing) for the power cable that are completely shielded and free from breaks.
- [2] Earth the shield on both the control panel side and motor chassis side. The shield earth position on the drive unit side must be 10cm or less from the control panel.
- [3] Earth the shield with a metal P clip or U clip.
(A cable clamp fitting can be used depending on the wire size.)
- [4] Directly earth the shield. Do not solder the braided shield onto a wire and earth the end of the wire.

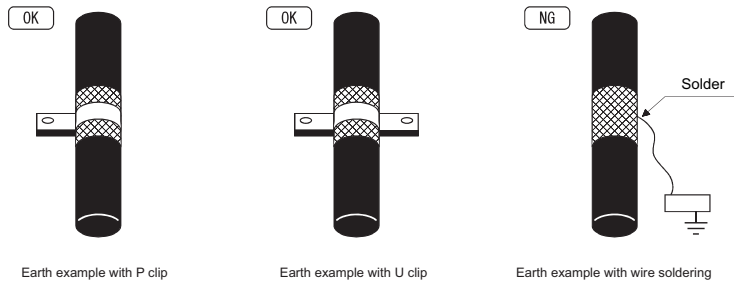

- [5] When not using a shield cable for the power cable, use a conventional cabtyre cable. Use a metal conduit outside the cable.
- [6] Earth the power cable on the control panel side at the contact surface of the conduit connector and control panel.
(Mask the side wall of the control panel with paint.)
- [7] Follow the treatment shown in the example for the conduit connector to earth the power cable on the motor side.
(Example: Use a clamp fitting, etc.)

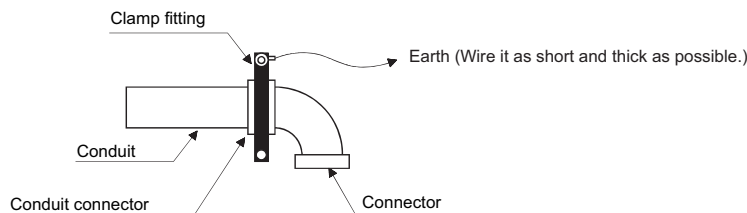

Appendix 1.5.4 Servo/Spindle Motor Encoder Cable

Use a shield pair cable for encoder cable of the servo motor to earth on NC side (inside the control panel.) Mounting a ferrite core directly behind the unit connector is also effective in suppressing noise.

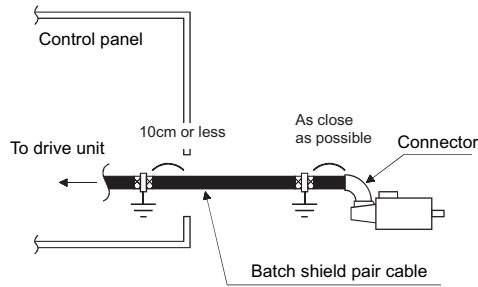

Encoder cable for servo motor

< Installation example >

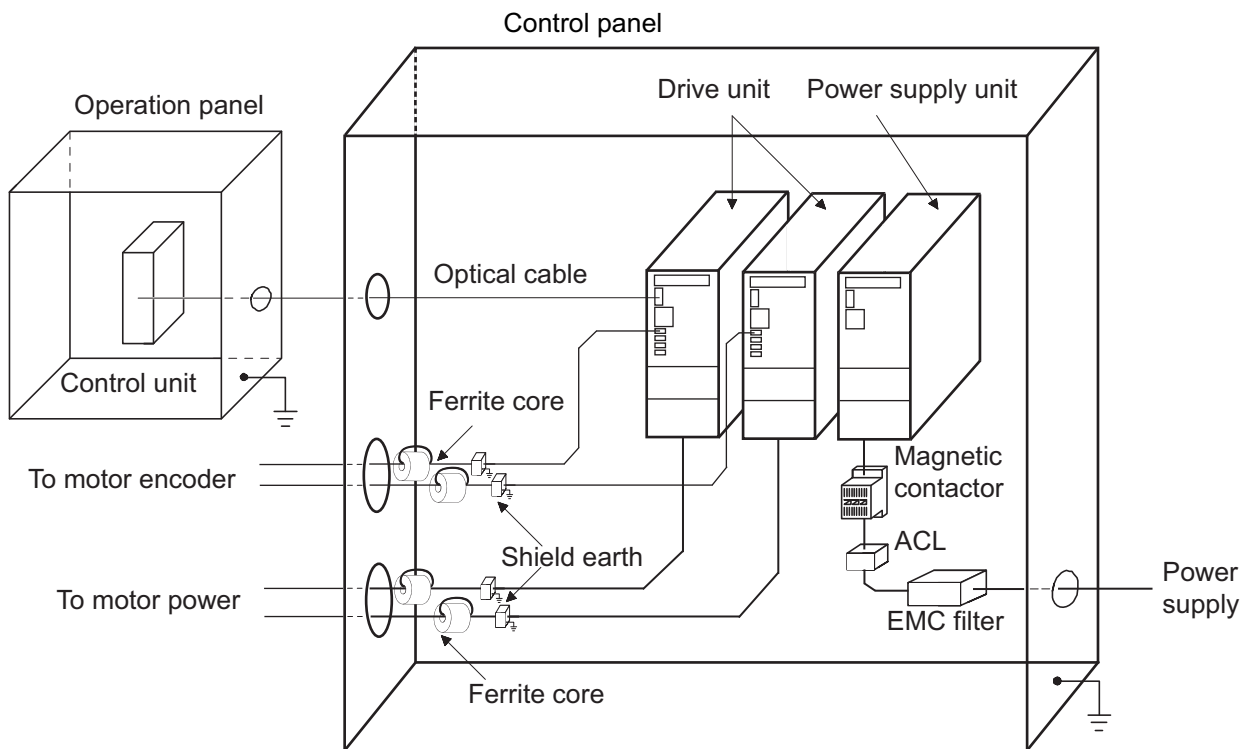

Appendix 1.6 EMC Countermeasure Parts

Appendix 1.6.1 Shield Clamp Fitting

The effect can be enhanced by connecting the cable directly to the earthing plate. Install an earthing plate near each panel's outlet (within 10cm), and press the cable against the earthing plate with the clamp fitting. If the cables are thin, several can be bundled and clamped together. Securely earth the earthing plate with the frame ground. Install directly on the cabinet or connect with an earthing wire.

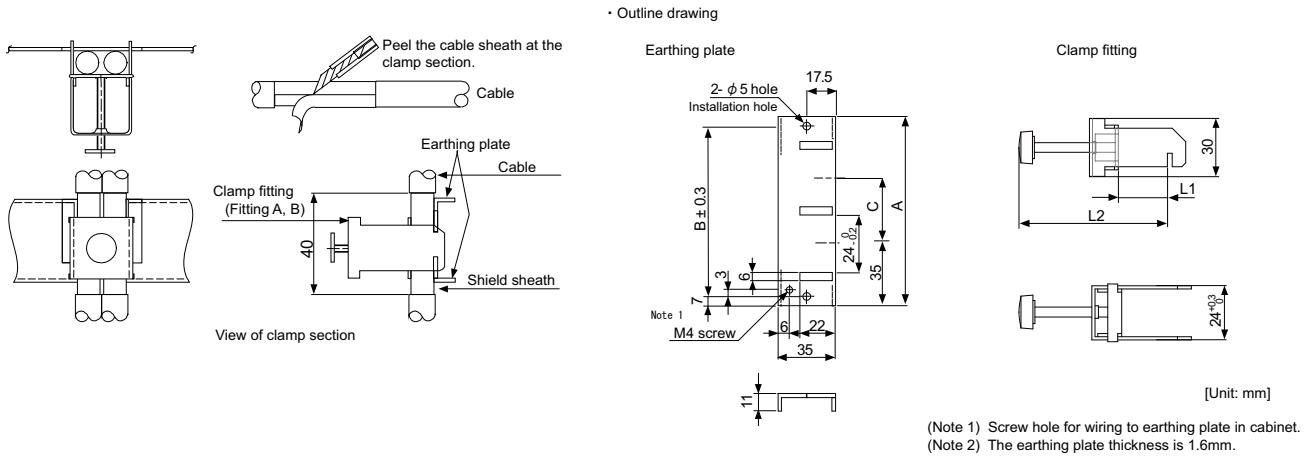

	A	B	C	Enclosed fittings
Ground Plate #D	100	86	30	Clamp fitting A x 2
Ground Plate #E	70	56	-	Clamp fitting B x 1

	L1 (maximum dimension when it is open)	L2 (reference dimension)
Clamp fitting A	25	(77)
Clamp fitting B	12	(54)

Appendix 1.6.2 Ferrite Core

Noise can be suppressed by installing a ferrite core to the cable if the power cable and encoder cable, which are led from outside of the control panel, are the noise sources.

Specify the frequency of radiated noise and select the ferrite with high impedance corresponding to the frequency.

By wrapping the cable around the ferrite core according to the cable diameter as shown in the example, the impedance rises, obtaining a better effect.

< Example of use >

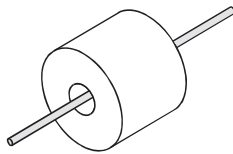

Lead through one time
(one turn)

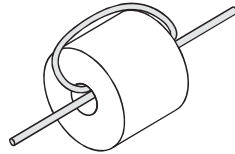

Lead through two times
(two turns)

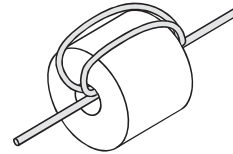

Lead through three times
(three turns)

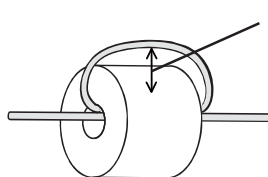

The clearance between the ferrite core and cable must be as narrow as possible when winding a cable.

< Recommended ferrite core >

A ferrite core is integrated and mounted on the plastic case. Quick installation is possible without cutting the interface cable or power cable. This ferrite core is effective against common mode noise, allowing measures against noise to be taken without affecting the signal quality.

TDK ZCAT Series

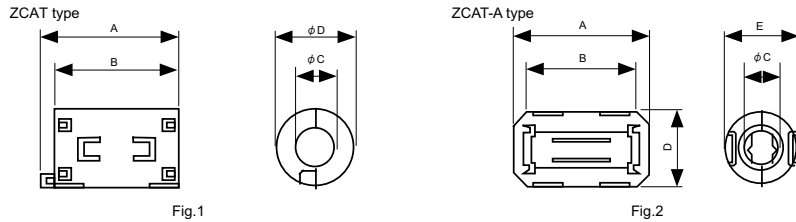

[Unit: mm]

Part name	Fig	A	B	C	D	E	Applicable cable outline	Mass
ZCAT3035-1330(-BK)*1	1	39±1	34±1	13	30	-	13max.	63
ZCAT2035-0930-M(-BK)	2	35±1	28±1	9±1	19.5±1	17.4±1	6 to 9	22

*1 A fixing band is enclosed when shipped.

Contact:
 TDK Corporation
<http://www.global.tdk.com/>

Kitagawa Industries GRFC Series

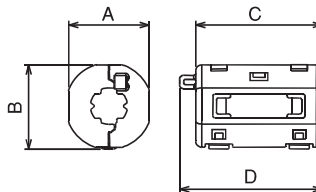

[Unit: mm]

Part number	A	B	C	D	Applicable bundle diameter	Impedance *Ω/100MHz (1 turn)
RFC-H13	31.7	29.4	41.0	-	Φ12.5 to 13.5	≥170
RFC-20	40.0	40.0	47.0	-	Max.Φ20	≥180

Contact:
 KITAGAWA INDUSTRIES CO.,LTD.
<http://www.kitagawa-ind.com/eng/>

Appendix 1.6.3 Power Line Filter

HF3000C-SZA Series for 200V/400V

■ Features

- (a) 3-phase 3-wire type (500V series)
- (b) Compatible with 200V/400V
- (c) Compliant with EU Standards EN55011 (Group 1 Class A)
- (d) Downsized for the space-saving book type

■ Application

- (a) Applications such as large machine tool, inverter, servo, etc.

■ Specifications

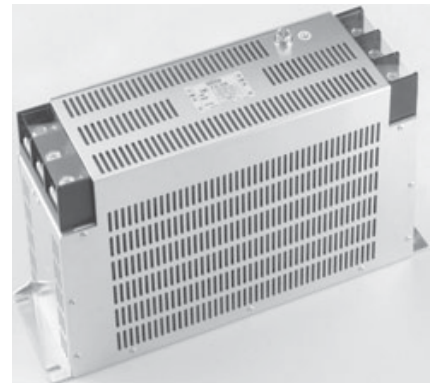

Part name	HF3000C-SZA Series											
	HF3010 C-SZA	HF3020 C-SZA	HF3030 C-SZA	HF3040 C-SZA	HF3050 C-SZA	HF3060 C-SZA	HF3080 C-SZA	HF3100 C-SZA	HF3150 C-SZA	HF3200 C-SZA	HF3250 C-SZA	HF3300 C-SZA
Rated voltage	3-phase 3-wire type 500VAC (530VAC max 50/60Hz)											
Rated current	10A	20A	30A	40A	50A	60A	80A	100A	150A	200A	250A	300A
Leakage current	7mA max 400VAC 50Hz(by UL1283)											
Ambient temp	-20 to 50°C											
Safety standards	CSA, UL1283/EN60939-2											
Vibration Resistance	Frequency: 10Hz to 55Hz Acceleration rate: 9.8m/s ²											

< Circuit diagram >

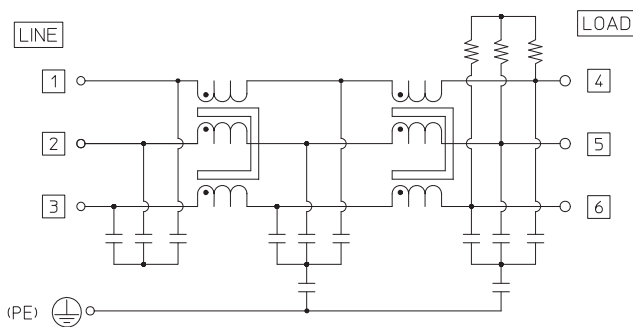

< Attenuation > Typical example: HF3150C-SZA

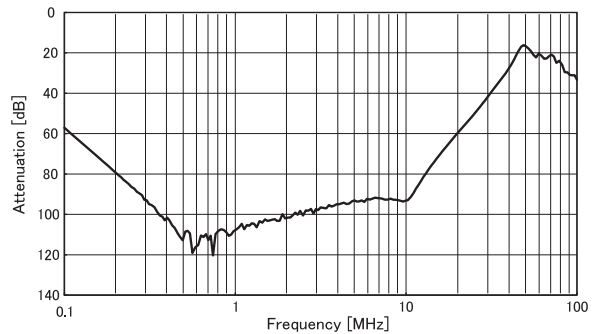

■ Outline dimensions

Model	Rated current	Mass (typ.)	Dimension [Unit:mm]		
			W	D	H
HF3010C-SZA	10A	0.9kg	220	66	78
HF3020C-SZA	20A	1.3kg			
HF3030C-SZA	30A	1.3kg			
HF3040C-SZA	40A	2.0kg	270	80	84
HF3050C-SZA	50A	2.0kg			
HF3060C-SZA	60A	2.1kg	310	100	210
HF3080C-SZA	80A	5.4kg			
HF3100C-SZA	100A	5.8kg			
HF3150C-SZA	150A	9.0kg	395	110	230
HF3200C-SZA	200A	11kg			
HF3250C-SZA	250A	12kg	400	120	260
HF3300C-SZA	300A	13kg			

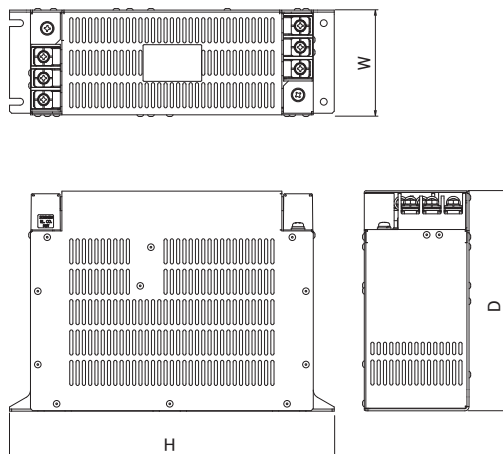

Appendix 1.6.4 Surge Absorber

Insert a surge absorber in the power input section to prevent damage to the control panel or power supply unit, etc. caused by the surge (lightning or sparks, etc.) applied on the AC power line.

Use a surge absorber that satisfies the following electrical specifications.

< Surge absorber for 200V >

RSPD Series for 200V (for both between phases and between phase and earth)

Part name	Rated voltage 50/60Hz	Voltage protection level	Surge withstand level 8/20 μs	Service temperature
RSPD-250-U4	3AC 250V	1300V	2500A	-40 to 70°C

< Surge absorber for 400V >

RSPD Series for 400V (for both between phases and between phase and earth)

Part name	Rated voltage 50/60Hz	Voltage protection level	Surge withstand level 8/20μs	Service temperature
RSPD-500-U4	3AC 500V	2000V	2500A	-40 to 70°C

[Unit: mm]

Outline dimension drawings

Circuit diagram

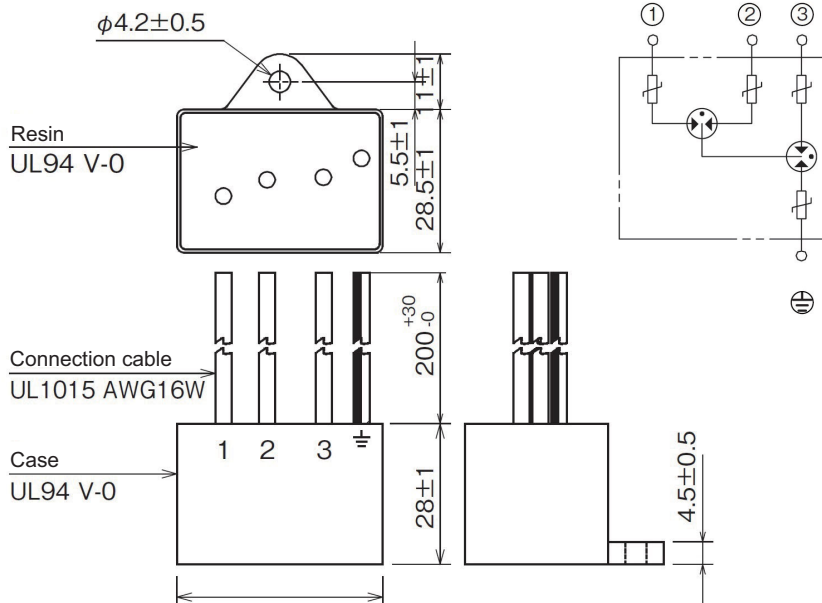

Contact: Okaya Electric Industries Co., Ltd. <http://www.okayaelec.co.jp/english/index.html>

< Example of surge absorber installation >

An example of installing the surge absorber in the machine control panel is shown below.

A short-circuit fault will occur in the surge absorber if a surge exceeding the tolerance is applied. Thus, install a circuit protector in the stage before the surge absorber. Note that almost no current flows to the surge absorber during normal use, so a circuit protector installed as the circuit protection for another device can be used for the surge absorber.

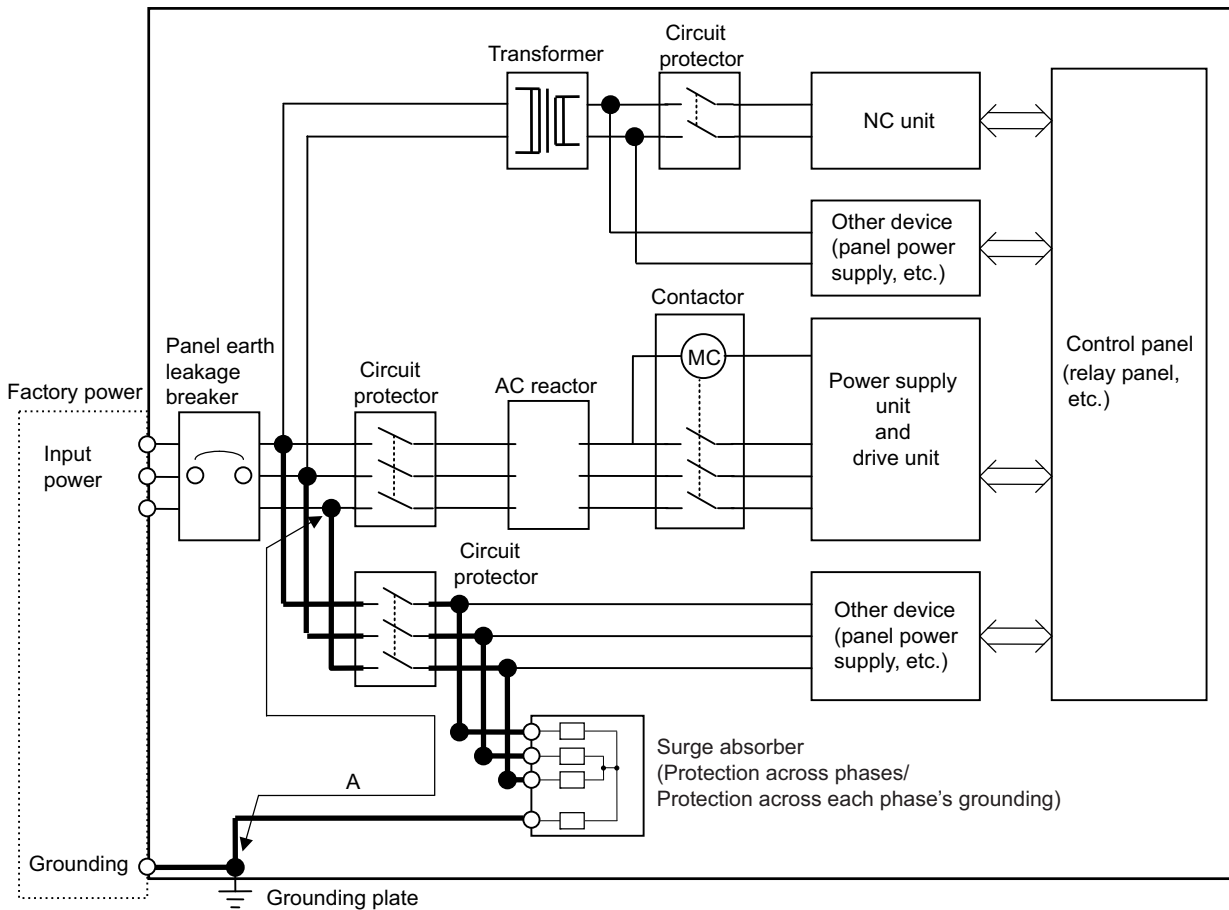

Installing the surge absorber

CAUTION

1. The wires from the surge absorber should be connected without extensions.
2. If the surge absorber cannot be installed just with the enclosed wires, keep the wiring length of A to 2m or less. If the wires are long, the surge absorber's performance may drop and inhibit protection of the devices in the panel.
3. Surge absorber to be selected varies depending on input power voltage.

Revision History

Date of revision	Manual No.	Revision details
Aug. 2015	IB(NA)1501296-A	First edition created.
Jul. 2017	IB(NA)1501296-B	<ul style="list-style-type: none"> - "Introduction" was revised. - "Replacement Model List" was revised. - "System Configuration" was revised. - "Spindle Drive Unit Type" was added. - "Drive unit" was revised. - "Unit Outline Drawing" was revised. - "Unit Outline Dimension Drawing" was revised. - "AC Reactor Outline Dimension Drawing" was revised. - "Explanation of Each Part" was revised. - "Setting DIP Switch" was added. - "Heating Value" was revised. - "EMC Installation Guidelines" was revised. - "EC Declaration of Conformity" was revised. - "Instruction Manual for Compliance with UL/c-UL Standard" was revised. - "Global Service Network" was revised. - Miswrite is corrected.
Mar. 2020	IB(NA)1501296-C	<ul style="list-style-type: none"> - Power supply unit MDS-C1-CV-N Series was added. - "Replacement Model List" was revised. - "Function Specifications List" was added. - "System Configuration" was revised. - "Power Supply Unit Type" was added. - "Servo Drive Unit" was revised. - "Spindle Drive Unit" was revised. - "Power Supply Unit" was added. - "AC Reactor" was revised. - "Unit Outline Dimension Drawing" was revised. - "AC Reactor Outline Dimension Drawing" was revised. - "Explanation of Each Part" was revised. - "Setting the Rotary Switch" was added. - "Heating Value" was revised. - "Dedicated Adapter for Main Circuit Power Supply (CNU01SC1NCV)" was added. - "MC Extension Kit (MC-SET)" was added. - "External Emergency Stop Conversion Cable" was added. - "Troubleshooting" was added. - "Specifications of Peripheral Devices" was added. - "EC Declaration of Conformity" was deleted. - "Instruction Manual for Compliance with UL/c-UL Standard" was deleted. - Miswrite is corrected.

Global Service Network

AMERICA

MITSUBISHI ELECTRIC AUTOMATION INC. (AMERICA FA CENTER)

Central Region Service Center (Chicago)
500 CORPORATE WOODS PARKWAY, VERNON HILLS, ILLINOIS 60061, U.S.A.
TEL: +1-847-478-2500 / FAX: +1-847-478-2650

Minneapolis, MN Service Satellite
Detroit, MI Service Satellite
Grand Rapids, MI Service Satellite
Lima, OH Service Satellite
Cleveland, OH Service Satellite
Indianapolis, IN Service Satellite
St. Louis, MO Service Satellite

South/East Region Service Center (Georgia)

1845 SATELLITE BOULEVARD STE. 450, DULUTH, GEORGIA 30097, U.S.A.
TEL: +1-678-258-4529 / FAX: +1-678-258-4519

Charleston, SC Service Satellite
Charlotte, NC Service Satellite
Raleigh, NC Service Satellite
Dallas, TX Service Satellite
Houston, TX Service Satellite
Hartford, CT Service Satellite
Knoxville, TN Service Satellite
Nashville, TN Service Satellite
Baltimore, MD Service Satellite
Pittsburg, PA Service Satellite
Newark, NJ Service Satellite
Syracuse, NY Service Satellite
Ft. Lauderdale, FL Service Satellite
Lafayette, LA Service Satellite

Western Region Service Center (California)

5900-B KATELLA AVE. - 5900-A KATELLA AVE. CYPRESS, CALIFORNIA 90630, U.S.A.
TEL: +1-714-699-2625 / FAX: +1-847-478-2650

San Francisco, CA Service Satellite
Seattle, WA Service Satellite
Denver, CO Service Satellite

Canada Region Service Center (Tronto)

4299 14TH AVENUE MARKHAM, ONTARIO L3R 0J2, CANADA
TEL: +1-905-754-3805 / FAX: +1-905-475-7935

Edmonton, AB Service Satellite
Montreal, QC Service Satellite

Mexico Region Service Center (Querétaro)

Parque Tecnológico Innovación Querétaro, Lateral Carretera Estatal 431, Km 2+200, Lote 91 Modulos 1 y 2
Hacienda la Machorra, CP 76246, El Marqués, Querétaro, México
TEL: +52-442-153 6050

Monterrey, NL Service Satellite
Mexico City, DF Service Satellite
Aguascalientes, AGS, Service Satellite

BRAZIL

MITSUBISHI ELECTRIC DO BRASIL COMÉRCIO E SERVIÇOS LTDA.

Votorantim Office
AV. GISELE CONSTANTINO,1578, PARQUE BELA VISTA, VOTORANTIM-SP, BRAZIL CEP:18.110-650
TEL: +55-15-3023-9000

Blumenau Santa Catarina office
MAQSERVICE – Canoas, RS Service Satellite

EUROPE

MITSUBISHI ELECTRIC EUROPE B.V.

European Service Headquarters (Dusseldorf, GERMANY)
Mitsubishi-Electric-Platz 1 40882 RATINGEN, GERMANY
TEL: +49-2102-486-5000 / FAX: +49-2102-486-5910

South Germany Service Center (Stuttgart)

SCHELMENWASENSTRASSE 16-20, 70567 STUTTGART, GERMANY
TEL: + 49-711-770598-123 / FAX: +49-711-770598-141

France Service Center (Paris)

25, BOULEVARD DES BOUVETS, 92741 NANTERRE CEDEX FRANCE
TEL: +33-1-41-02-83-13 / FAX: +33-1-49-01-07-25

France Service Satellite (Lyon)

120, ALLEE JACQUES MONOD 69800 SAINT PRIEST FRANCE
TEL: +33-1-41-02-83-13 / FAX: +33-1-49-01-07-25

Italy Service Center (Milan)

CENTRO DIR. COLLEONI, PALAZZO SIRIO, VIALE COLLEONI 7, 20864 AGRATE BRIANZA (MB) ITALY
TEL: +39-039-6053-342 / FAX: +39-039-6053-206

Italy Service Satellite (Padova)

VIA G. SAVELLI, 24 - 35129 PADOVA, ITALY
TEL: +39-039-6053-342 / FAX: +39-039-6053-206

U.K. Service Center

TRAVELLERS LANE, HATFIELD, HERTFORDSHIRE, AL10 8XB, U.K.
TEL: +49-2102-486-5000 / FAX: +49-2102-486-5910

Spain Service Center

CTRA. RUBI, 76-80 8174 SAINT CUGAT DEL VALLES, BARCELONA SPAIN
TEL: +34-935-65-2236 / FAX: +34-935-89-1579

Poland Service Center

UL.KRAKOWSKA 50, 32-083 BALICE, POLAND
TEL: +48-12-347-6500 / FAX: +48-12-630-4701

Hungary Service Center

MADARASZ IRODAPARK, MADARASZ VIKTOR UT 47-49, 1138 BUDAPEST, HUNGARY
TEL: +48-12-347-6500 / FAX: +48-12-630-4701

Turkey Service Center

MITSUBISHI ELECTRIC TURKEY A.Ş
SERIFALI MAHALLESİ NUTUK SOKAK. NO.41 34775
UMRANIYE, ISTANBUL, TURKEY
TEL: +90-216-969-2500 / FAX: +90-216-526-3995

Czech Republic Service Center

AutoCont Control Systems s.r.o (Service Partner)
KAFKOVA 1853/3, 702 00 OSTRAVA 2, CZECH REPUBLIC
TEL: +420-59-5691-185 / FAX: +420-59-5691-199

Russia Service Center

MITSUBISHI ELECTRIC RUSSIA LLC
LETNIKOVSKAYA STREET 2, BLD.1, 5TH 115114 MOSCOW, RUSSIA
TEL: +7-495-721-2070 / FAX: +7-495-721-2071

Sweden Service Center

HAMMARBACKEN 14, P.O.BOX 750 SE-19127, SOLLENTUNA, SWEDEN
TEL: +46-8-6251000 / FAX: +46-8-966877

Bulgaria Service Center

AKHNATON Ltd. (Service Partner)
4 ANDREJ LJAPCHEV BLVD. POB 21, BG-1756 SOFIA, BULGARIA
TEL: +359-2-8176009 / FAX: +359-2-9744061

Ukraine Service Center (Kiev)

CSC Automation Ltd. (Service Partner)
4 B. YEVHENA SVERSTYUKA STR., 02002 KIEV, UKRAINE
TEL: +380-44-494-3344 / FAX: +380-44-494-3366

Belarus Service Center

TECHNIKON Ltd. (Service Partner)
NEZAVISIMOSTI PR.177, 220125 MINSK, BELARUS
TEL: +375-17-393-1177 / FAX: +375-17-393-0081

South Africa Service Center

MOTIONTRONIX (Service Partner)
P.O. BOX 9234, EDLEEN, KEMPTON PARK GAUTENG, 1625, SOUTH AFRICA
TEL: +27-11-394-8512 / FAX: +27-11-394-8513

ASEAN**MITSUBISHI ELECTRIC ASIA PTE. LTD. (ASEAN FA CENTER)**

Singapore Service Center
307 ALEXANDRA ROAD #05-01/02 MITSUBISHI ELECTRIC BUILDING SINGAPORE 159943
TEL: +65-6473-2308 / FAX: +65-6476-7439

PHILIPPINE**MELCO FACTORY AUTOMATION PHILIPPINES INC.**

Head Office
128 LOPEZ RIZAL STREET, BRGY., HIGHWAY HILLS, MANDALUYONG CITY, MM PHILIPPINES 1550
TEL: +63-2-8256-8042 / FAX: +632-8637-2294

Philippines Service Center
KM.23 WEST SERVICE ROAD SSH, CUPANG, MUNTINLUPA CITY PHILIPPINES
TEL: +63-2-8807-0420 / FAX: +63-2-8842-5202

VIETNAM**MITSUBISHI ELECTRIC VIETNAM CO., LTD.**

Vietnam Ho Chi Minh Service Center
UNIT 01-04, 10TH FLOOR, VINCOM CENTER 72 LE THANH TON STREET, DISTRICT1,
HO CHI MINH CITY, VIETNAM
TEL: +84-28-3910 5945 / FAX: +84-28-3910 5947

Vietnam Hanoi Service Center
24TH FLOOR, HANDICO TOWER, PHAM HUNG ROAD, ME TRI HA, ME TRI WARD,
NAM TU LIEM DISTRICT, HA NOI CITY, VIETNAM
TEL: +84-24-3937-8075 / FAX: +84-24-3937-8076

INDONESIA**PT. MITSUBISHI ELECTRIC INDONESIA**

Indonesia Service Center (Cikarang)
JL. KENARI RAYA BLOK G2-07A, DELTA SILICON 5, LIPPO CIKARANG - BEKASI 17550, INDONESIA
TEL: +62-21-2961-7797 / FAX: +62-21-2961-7794

MALAYSIA**MITSUBISHI ELECTRIC SALES MALAYSIA SDN. BHD.**

Malaysia Service Center (Kuala Lumpur Service Center)
LOT 11, JALAN 219, P.O BOX 1036, 46860 PETALING JAYA, SELANGOR DARUL EHSAN. MALAYSIA
TEL: +60-3-7960-2628 / FAX: +60-3-7960-2629
Johor Bahru Service Satellite

THAILAND**MITSUBISHI ELECTRIC FACTORY AUTOMATION (THAILAND) CO., LTD.**

Thailand Service Center (Bangkok)
101, TRUE DIGITAL PARK OFFICE, 5TH FLOOR, SUKHUMVIT ROAD, BANGCHAK, PHRAKHANONG,
BANGKOK, 10260 THAILAND
TEL: +66-2-092-8600 / FAX: +66-2-043-1231-33
Bowin Service Center (Chonburi)
Korat Service Center

INDIA**MITSUBISHI ELECTRIC INDIA PVT., LTD.**

CNC Technical Center (Bangalore)
PLOT NO. 56, 4TH MAIN ROAD, PEENYA PHASE 3,
PEENYA INDUSTRIAL AREA, BANGALORE 560058, KARNATAKA, INDIA
TEL: +91-80-4655-2121 / FAX: +91-80-4655-2147
Chennai Service Satellite
Coimbatore Service Satellite
Hyderabad Service Satellite

North India Service Center (Gurgaon)
2ND FLOOR, TOWER A&B, DLF CYBER GREENS, DLF CYBER CITY,
DLF PHASE-III, GURGAON- 122 002, HARYANA, INDIA
TEL: +91-124-4630 300 / FAX: +91-124-4630 399
Ludhiana Service Satellite
Panth Nagar Service Satellite
Delhi Service Satellite
Jamshedpur Service Satellite
Manesar Service Satellite

West India Service Center (Pune)
ICC-Devi GAURAV TECHNOLOGY PARK, UNIT NO.402, FOURTH FLOOR, NORTH WING,
SURVEY NUMBER 191-192 (P), NEXT TO INDIAN CARD CLOTHING COMPANY Ltd,
OPP. VALLABH NAGAR, PIMPRI, PUNE- 411 018, MAHARASHTRA, INDIA
TEL: +91-20-6819 2274 / FAX: +91-20-4624 2100
Kolhapur Service Satellite
Aurangabad Service Satellite
Mumbai Service Satellite

West India Service Center (Ahmedabad)
204-209, 2ND FLOOR, 31FIVE, CORPORATE ROAD PRAHLADNAGAR,
AHMEDABAD -380015, GUJARAT, INDIA
TEL: + 91-79-6777 7888
Rajkot Service Satellite

CHINA**MITSUBISHI ELECTRIC AUTOMATION (CHINA) LTD. (CHINA FA CENTER)**

CNC Call Center
TEL: +86-400-921-5130

Shanghai Service Center
1-3,5-10,18-23/F, NO.1386 HONG QIAO ROAD, CHANG NING QU,
SHANGHAI 200336, CHINA
TEL: +86-21-2322-3030 / FAX: +86-21-2322-3000*8422

Qingdao Service Center
Suzhou Service Center
Wuhan Service Center
Ningbo Service Center
Hefei Service Center
Beijing Service Center
Tianjin Service Center
Xian Service Center
Dalian Service Center
Chengdu Service Center

Shenzhen Service Center
LEVEL8, GALAXY WORLD TOWER B, 1 YABAO ROAD, LONGGANG DISTRICT,
SHENZHEN 518129, CHINA

TEL: +86-755-2399-8272 / FAX: +86-755-8229-3686
Dongguan Service Center
Xiamen Service Center

KOREA**MITSUBISHI ELECTRIC AUTOMATION KOREA CO., LTD. (KOREA FA CENTER)**

Korea Service Center
8F GANGSEO HANGANG XI-TOWER A, 401 YANGCHEON-RO, GANGSEO-GU,
SEOUL 07528 KOREA
TEL: +82-2-3660-9609 / FAX: +82-2-3664-8668
Korea Daegu Service Satellite

TAIWAN**MITSUBISHI ELECTRIC TAIWAN CO., LTD. (TAIWAN FA CENTER)**

Taiwan Taichung Service Center
NO.8-1, INDUSTRIAL 16TH RD., TAICHUNG INDUSTRIAL PARK, SITUN DIST.,
TAICHUNG CITY 40768, TAIWAN
TEL: +886-4-2359-0688 / FAX: +886-4-2359-0689

Taiwan Taipei Service Center
10F, NO.88, SEC.6, CHUNG-SHAN N. RD., SHI LIN DIST., TAIPEI CITY 11155, TAIWAN
TEL: +886-2-2833-5430 / FAX: +886-2-2833-5433

Taiwan Tainan Service Center
11F-1., NO.30, ZHONGZHENG S. ROAD, YONGKANG DISTRICT, TAINAN CITY 71067, TAIWAN
TEL: +886-6-252-5030 / FAX: +886-6-252-5031

OCEANIA**MITSUBISHI ELECTRIC AUSTRALIA PTY. LTD.**

Oceania Service Center
348 VICTORIA ROAD, RYDALMERE, N.S.W. 2116 AUSTRALIA
TEL: +61-2-9684-7269 / FAX: +61-2-9684-7245

Notice

Every effort has been made to keep up with software and hardware revisions in the contents described in this manual. However, please understand that in some unavoidable cases simultaneous revision is not possible.

Please contact your Mitsubishi Electric dealer with any questions or comments regarding the use of this product.

Duplication Prohibited

This manual may not be reproduced in any form, in part or in whole, without written permission from Mitsubishi Electric Corporation.

© 2015-2020 Mitsubishi Electric Corporation
ALL RIGHTS RESERVED

MITSUBISHI ELECTRIC CORPORATION

HEAD OFFICE : TOKYO BLDG.,2-7-3 MARUNOUCHI,CHIYODA-KU,TOKYO 100-8310,JAPAN

MODEL	MDS-C1-N Series
MODEL CODE	100-487
Manual No.	IB-1501296