

Standard Rectifier Module

$$\begin{aligned} V_{RRM} &= 2 \times 800 \text{ V} \\ I_{FAV} &= 190 \text{ A} \\ V_F &= 0.96 \text{ V} \end{aligned}$$

Phase leg

Part number

MDD172-08N1

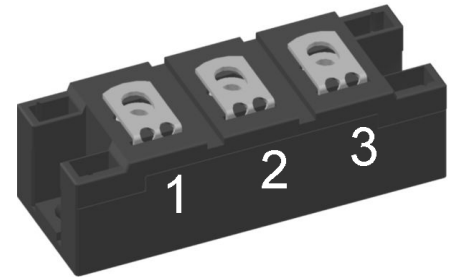

Backside: isolated

 E72873

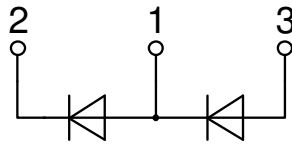

Features / Advantages:

- Package with DCB ceramic
- Improved temperature and power cycling
- Planar passivated chips
- Very low forward voltage drop
- Very low leakage current

Applications:

- Diode for main rectification
- For single and three phase bridge configurations
- Supplies for DC power equipment
- Input rectifiers for PWM inverter
- Battery DC power supplies
- Field supply for DC motors

Package: Y4

- Isolation Voltage: 3600 V~
- Industry standard outline
- RoHS compliant
- Soldering pins for PCB mounting
- Base plate: DCB ceramic
- Reduced weight
- Advanced power cycling

Terms Conditions of usage:

The data contained in this product data sheet is exclusively intended for technically trained staff. The user will have to evaluate the suitability of the product for the intended application and the completeness of the product data with respect to his application. The specifications of our components may not be considered as an assurance of component characteristics. The information in the valid application- and assembly notes must be considered. Should you require product information in excess of the data given in this product data sheet or which concerns the specific application of your product, please contact your local sales office.

Due to technical requirements our product may contain dangerous substances. For information on the types in question please contact your local sales office.

Should you intend to use the product in aviation, in health or life endangering or life support applications, please notify. For any such application we urgently recommend

- to perform joint risk and quality assessments;

- the conclusion of quality agreements;

- to establish joint measures of an ongoing product survey, and that we may make delivery dependent on the realization of any such measures.

Rectifier				Ratings			
Symbol	Definition	Conditions	min.	typ.	max.	Unit	
V_{RSM}	max. non-repetitive reverse blocking voltage	$T_{VJ} = 25^{\circ}C$			900	V	
V_{RRM}	max. repetitive reverse blocking voltage	$T_{VJ} = 25^{\circ}C$			800	V	
I_R	reverse current	$V_R = 800 V$	$T_{VJ} = 25^{\circ}C$		1	mA	
		$V_R = 800 V$	$T_{VJ} = 150^{\circ}C$		20	mA	
V_F	forward voltage drop	$I_F = 150 A$	$T_{VJ} = 25^{\circ}C$		1.07	V	
		$I_F = 300 A$			1.22	V	
		$I_F = 150 A$	$T_{VJ} = 125^{\circ}C$		0.96	V	
		$I_F = 300 A$			1.16	V	
I_{FAV}	average forward current	$T_C = 100^{\circ}C$	$T_{VJ} = 150^{\circ}C$		190	A	
$I_{F(RMS)}$	RMS forward current	180° sine			300	A	
V_{F0}	threshold voltage	} for power loss calculation only	$T_{VJ} = 150^{\circ}C$		0.80	V	
r_F	slope resistance				0.8	mΩ	
R_{thJC}	thermal resistance junction to case				0.21	K/W	
R_{thCH}	thermal resistance case to heatsink			0.08		K/W	
P_{tot}	total power dissipation		$T_C = 25^{\circ}C$		600	W	
I_{FSM}	max. forward surge current	$t = 10 \text{ ms}; (50 \text{ Hz}), \text{ sine}$	$T_{VJ} = 45^{\circ}C$		6.60	kA	
		$t = 8,3 \text{ ms}; (60 \text{ Hz}), \text{ sine}$	$V_R = 0 V$		7.13	kA	
		$t = 10 \text{ ms}; (50 \text{ Hz}), \text{ sine}$	$T_{VJ} = 150^{\circ}C$		5.61	kA	
		$t = 8,3 \text{ ms}; (60 \text{ Hz}), \text{ sine}$	$V_R = 0 V$		6.06	kA	
I^2t	value for fusing	$t = 10 \text{ ms}; (50 \text{ Hz}), \text{ sine}$	$T_{VJ} = 45^{\circ}C$		217.8	kA ² s	
		$t = 8,3 \text{ ms}; (60 \text{ Hz}), \text{ sine}$	$V_R = 0 V$		211.5	kA ² s	
		$t = 10 \text{ ms}; (50 \text{ Hz}), \text{ sine}$	$T_{VJ} = 150^{\circ}C$		157.4	kA ² s	
		$t = 8,3 \text{ ms}; (60 \text{ Hz}), \text{ sine}$	$V_R = 0 V$		152.8	kA ² s	
C_J	junction capacitance	$V_R = 400 V; f = 1 \text{ MHz}$	$T_{VJ} = 25^{\circ}C$		238	pF	

Package Y4				Ratings			
Symbol	Definition	Conditions	min.	typ.	max.	Unit	
I_{RMS}	RMS current	per terminal			300	A	
T_{VJ}	virtual junction temperature		-40		150	°C	
T_{op}	operation temperature		-40		125	°C	
T_{stg}	storage temperature		-40		125	°C	
Weight					150	g	
M_D	mounting torque		2.25		2.75	Nm	
M_T	terminal torque		4.5		5.5	Nm	
$d_{Spp/App}$	creepage distance on surface striking distance through air	terminal to terminal	14.0	10.0		mm	
$d_{Spb/Apb}$		terminal to backside	16.0	16.0		mm	
V_{ISOL}	isolation voltage	t = 1 second			3600	V	
		t = 1 minute	50/60 Hz, RMS; $I_{ISOL} \leq 1$ mA		3000	V	

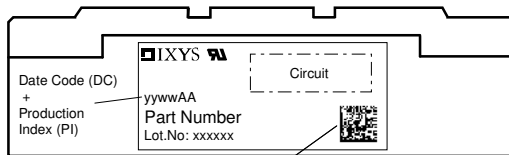

Data Matrix: part no. (1-19), DC + PI (20-25), lot.no.# (26-31), blank (32), serial no.# (33-36)

Ordering	Ordering Number	Marking on Product	Delivery Mode	Quantity	Code No.
Standard	MDD172-08N1	MDD172-08N1	Box	6	429694

Equivalent Circuits for Simulation

* on die level

$T_{VJ} = 150^\circ\text{C}$



Rectifier

$V_{0\ max}$	threshold voltage	0.8	V
$R_{0\ max}$	slope resistance *	0.4	mΩ

Outlines Y4

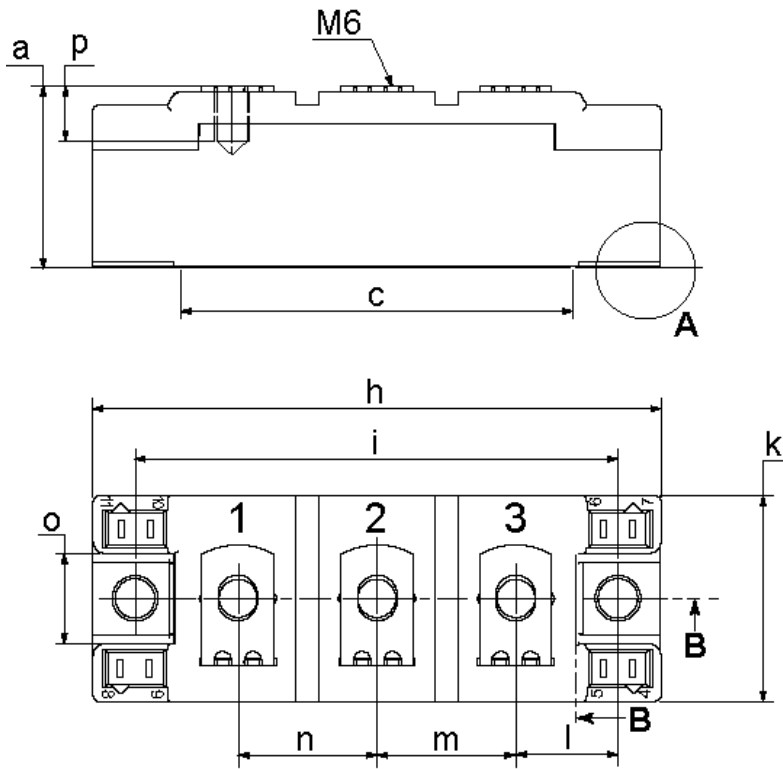

Dim.	MIN [mm]	MAX [mm]	MIN [inch]	MAX [inch]
a	30.0	30.6	1.181	1.205
b	typ. 0.25		typ. 0.010	
c	64.0	65.0	2.520	2.559
d	6.5	7.0	0.256	0.275
e	4.9	5.1	0.193	0.201
h	93.5	94.5	3.681	3.720
i	79.5	80.5	3.130	3.169
k	33.4	34.0	1.315	1.339
l	16.7	17.3	0.657	0.681
m	22.7	23.3	0.894	0.917
n	22.7	23.3	0.894	0.917
o	14.0	15.0	0.551	0.591
p	typ. 10.5		typ. 0.413	

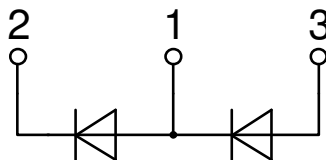
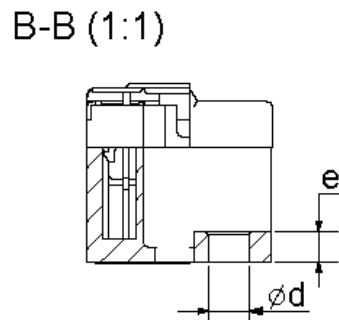
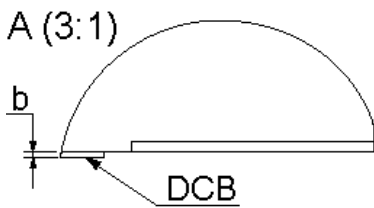

Rectifier

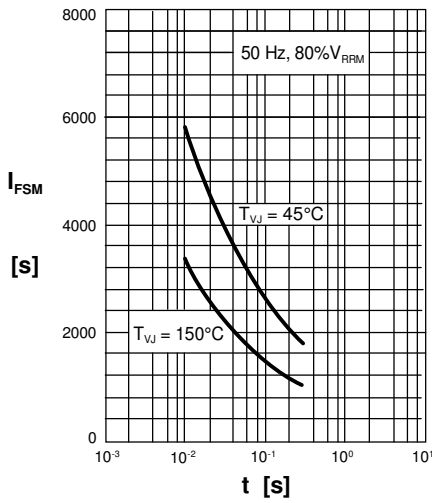

Fig. 1 Surge overload current
 I_{FSM} : Crest value, t: duration

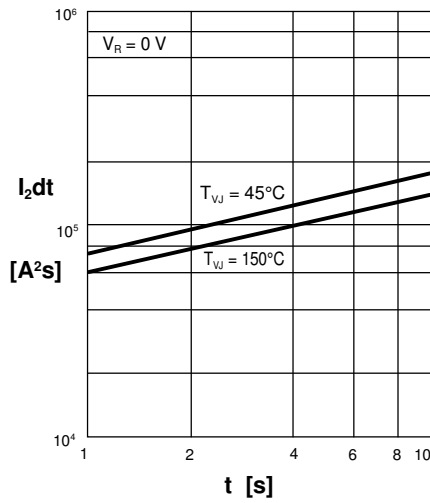

Fig. 2 I_2dt versus time (1-10 ms)

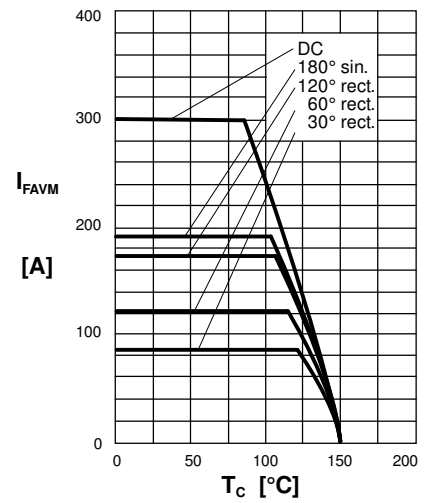

Fig. 2a Maximum forward current at case temperature

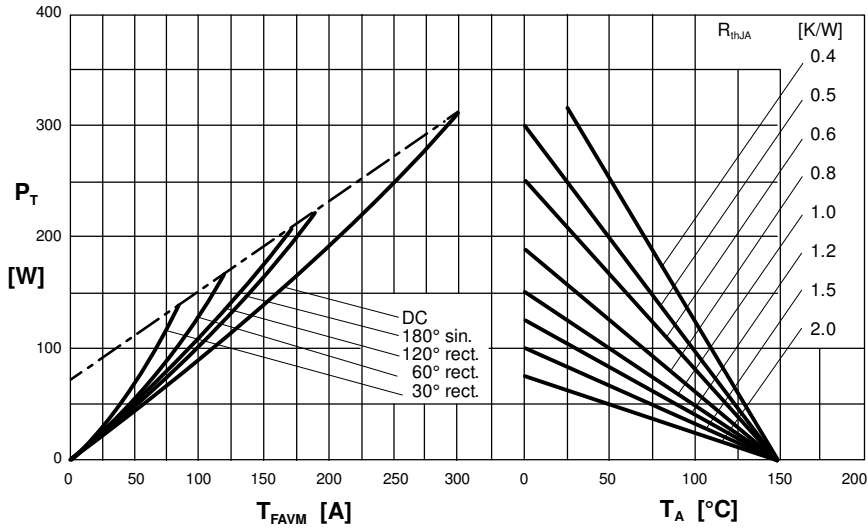
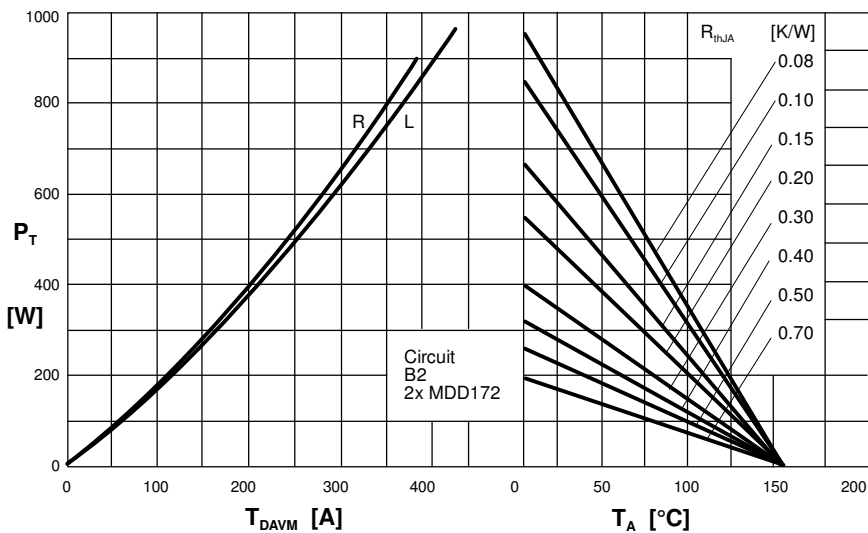

Fig. 3 Power dissipation vs. forward current and ambient temperature (per diode)



R = resistive load
 L = inductive load

Fig. 4 Single phase rectifier bridge: Power dissipation vs. direct output current and ambient

Rectifier

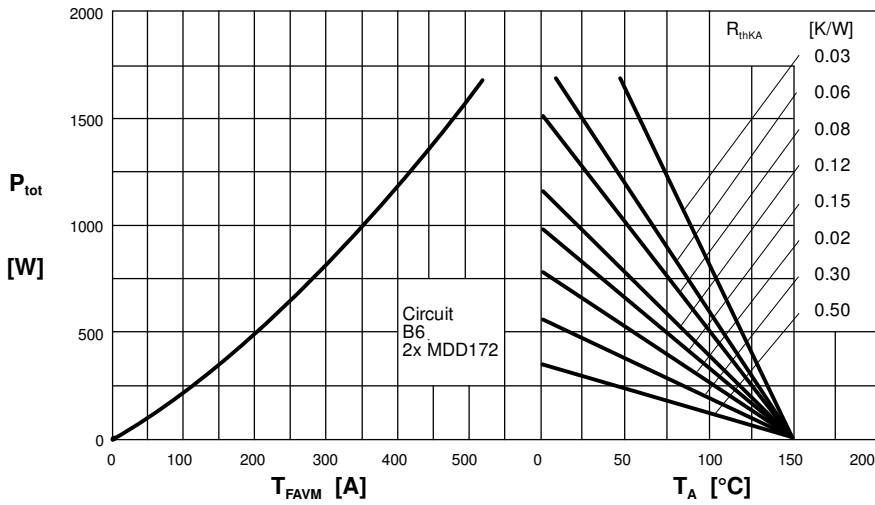

Fig. 5 Three phase rectifier bridge: Power dissipation vs. direct output current and ambient temperature

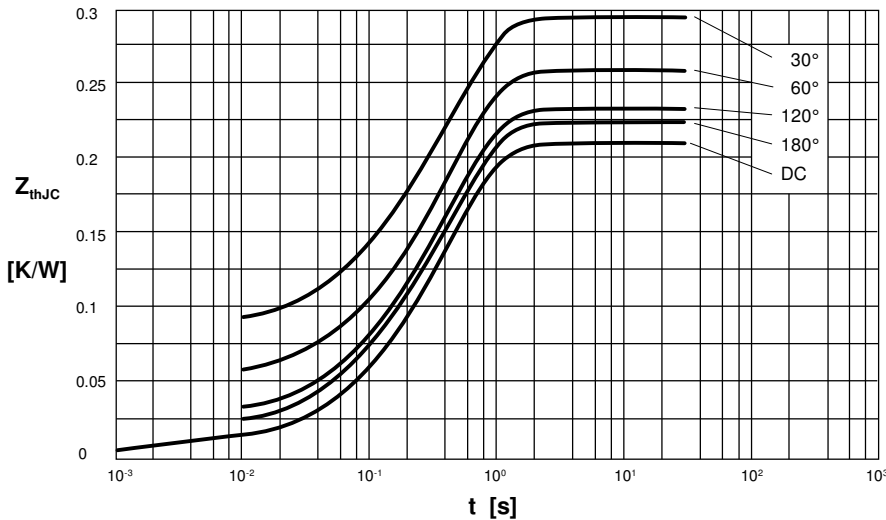

Fig. 6 Transient thermal impedance junction to case (per diode)

R_{thJC} for various conduction angles d :

d	R_{thJC} [K/W]
DC	0.210
180°	0.223
120°	0.233
60°	0.260
30°	0.295

Constants for Z_{thJC} calculation:

i	R_{thi} [K/W]	t_i [s]
1	0.0087	0.001
2	0.0163	0.065
3	0.1850	0.400

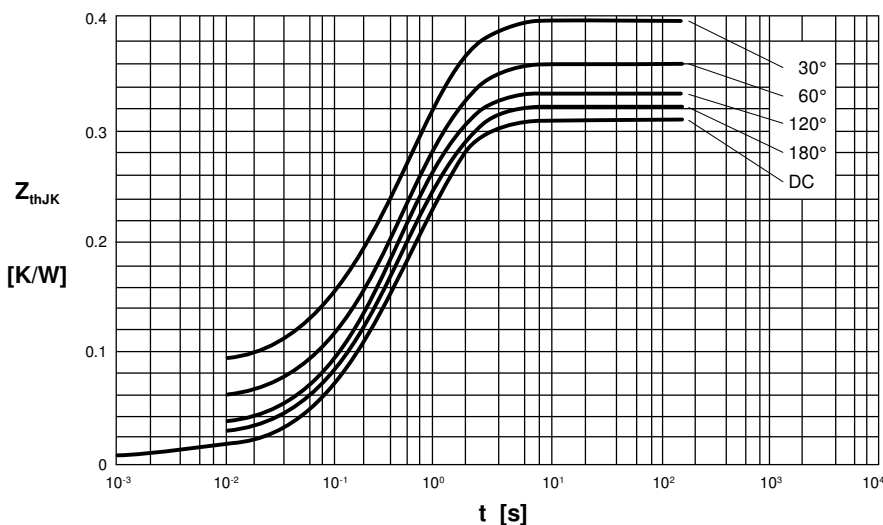

Fig. 7 Transient thermal impedance junction to heatsink (per diode)

R_{thJK} for various conduction angles d :

d	R_{thJK} [K/W]
DC	0.310
180°	0.323
120°	0.333
60°	0.360
30°	0.395

Constants for Z_{thJK} calculation:

i	R_{thi} [K/W]	t_i [s]
1	0.0087	0.001
2	0.0163	0.065
3	0.1850	0.400
4	0.1000	1.290