

Dual Darlington Transistor Module 50 Amperes/1200 Volts

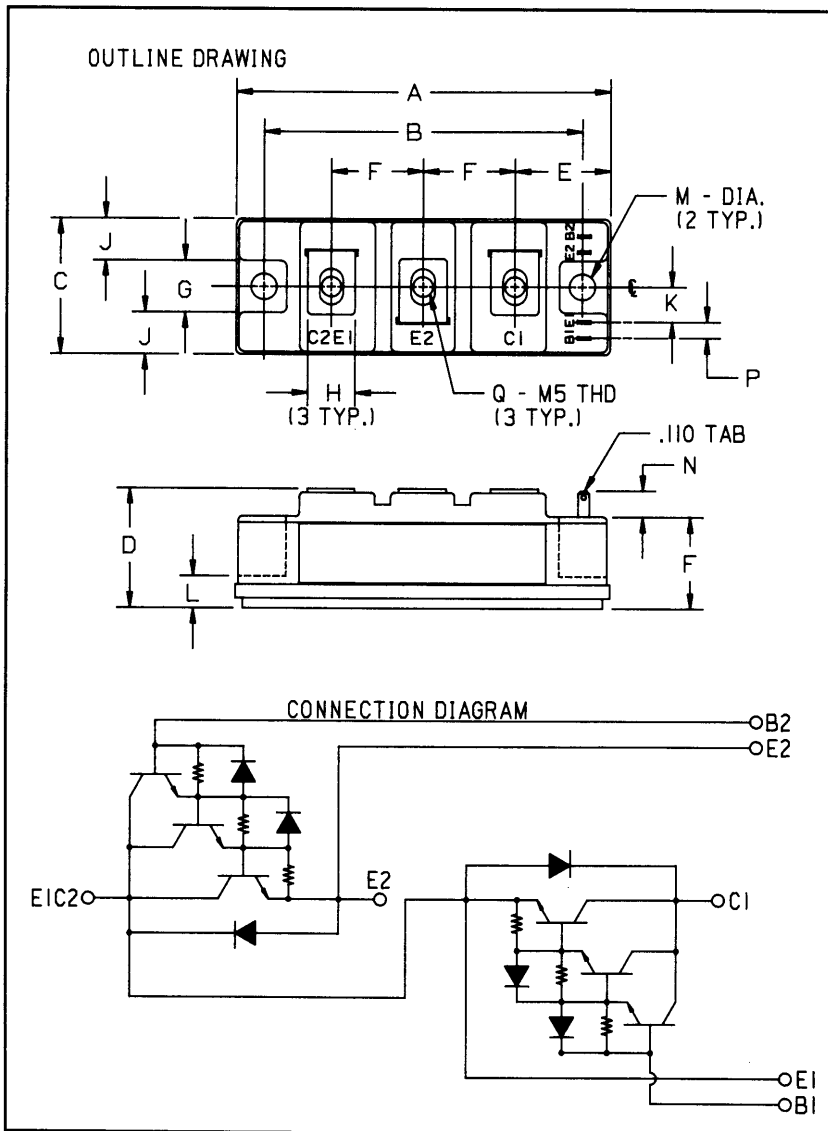

Outline Drawing

Dimensions	Inches	Millimeters
A	3.701 Max.	94 Max.
B	3.150 ± 0.010	80 ± 0.25
C	1.339 Max.	34 Max.
D	1.181 Max.	30 Max.
E	0.945	24
F	0.906	23
G	0.512	13
H	0.472	12

Dimensions	Inches	Millimeters
J	0.413	10.5
K	0.344	8.75
L	0.315	8
M	0.256 Dia.	6.5 Dia.
N	0.256 Min.	6.5 Min.
P	0.157	4
Q	M5 Metric	M5

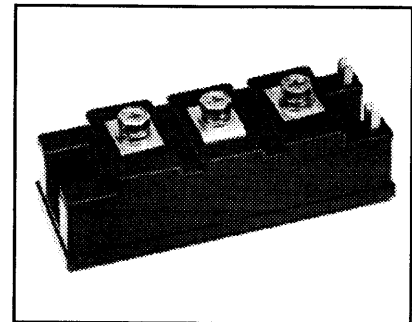

Description:

The Powerex Dual Darlington Transistor Modules are high power devices designed for use in switching applications. The modules are isolated, consisting of two Darlington Transistors with each transistor having a reverse parallel connected high-speed diode.

Features:

- Isolated Mounting
- Planar Chips
- Discrete Fast Recovery Feedback Diode
- High Gain (h_{FE})
- Quick Connect Base-Emitter Signal Terminals
- Base-Emitter Speed-up Diodes

Applications:

- AC Motor Control
- DC Motor Control
- Switching Power Supplies
- Inverters

Ordering Information:

Example: Select the complete ten digit module part number you desire from the table - i.e. KD221205A7 is a 1200 Volt, 50 Ampere Dual Darlington Module with a gain of 75 at rated current (50 Amperes).

Type	$V_{CE0(sus)}$ Volts (X 100)	Current Rating Amperes (X 10)
KD22	12	05



Powerex, Inc., 200 Hillis Street, Youngwood, Pennsylvania 15697-1800 (412) 925-7272

KD221205A7
Dual Darlington Transistor Module
 50 Amperes/1200 Volts

Absolute Maximum Ratings, $T_j = 25\text{ }^\circ\text{C}$ unless otherwise specified

Ratings	Symbol	KD221205A7	Units
Junction Temperature	T_j	-40 to 150	$^\circ\text{C}$
Storage Temperature	T_{stg}	-40 to 125	$^\circ\text{C}$
Collector-Emitter Sustaining Voltage, $V_{BE} = -2\text{V}$	$V_{CEV(sus)}$	1200	Volts
Collector-Base Voltage	V_{CBO}	1200	Volts
Emitter-Base Voltage	V_{EBO}	7	Volts
Collector-Emitter Voltage, $V_{BE} = -2\text{V}$	V_{CEV}	1200	Volts
Continuous Collector Current	I_C	50	Amperes
Diode Forward Current	I_{FM}	530	Amperes
Continuous Base Current	I_B	3	Amperes
Diode Surge Current	I_{FSM}	500	Amperes
Power Dissipation (Each Transistor)	P_t	400	Watts
Max. Mounting Torque M5 Terminal Screws	-	17	in.-lb.
Max. Mounting Torque M6 Mounting Screws	-	26	in.-lb.
Module Weight (Typical)	-	210	Grams
V Isolation	V_{RMS}	2500	Volts

Electrical Characteristics, $T_j = 25\text{ }^\circ\text{C}$ unless otherwise specified

Characteristics	Symbol	Test Conditions	Min.	Typ.	Max.	Units	
Collector Cutoff Current	I_{CEV}	$V_{CE} = 1200\text{V}, V_{BE} = -2\text{V}$	-	-	1	mA	
		$V_{CE} = 1200\text{V}, V_{BE} = -2\text{V}, T_C = 125^\circ\text{C}$	-	-	10	mA	
Emitter Cutoff Current	I_{EBO}	$V_{EB} = 7\text{V}$	-	-	200	mA	
DC Current Gain	h_{FE}	$I_C = 50\text{A}, V_{CE} = 5\text{V}$	75	-	-	-	
Diode Forward Voltage	V_{FM}	$I_{FM} = 50\text{A}$	-	-	1.8	Volts	
Collector-Emitter Saturation Voltage	$V_{CE(sat)}$	$I_C = 50\text{A}, I_B = 1\text{A}$	-	-	3.0	Volts	
Base-Emitter Saturation Voltage	$V_{BE(sat)}$	$I_C = 50\text{A}, I_B = 1\text{A}$	-	-	3.5	Volts	
Resistive	Turn-on	t_{on}	$V_{CC} = 600\text{V}$	-	-	2.5	μs
Load	Storage Time	t_s	$I_C = 50\text{A}$	-	-	15	μs
Switch Times	Fall Time	t_f	$I_{B1} = 1\text{A}, I_{B2} = -1\text{A}$	-	-	3.0	μs

Thermal and Mechanical Characteristics, $T_j = 25\text{ }^\circ\text{C}$ unless otherwise specified

Characteristics	Symbol	Test Conditions	Min.	Typ.	Max.	Units
Thermal Resistance, Case-to-Sink	$R_{\theta(c-s)}$	Per 1/2 Module	-	-	0.15	$^\circ\text{C/W}$
Thermal Resistance, Junction-to-Case	$R_{\theta(j-c)}$	Transistor Part	-	-	0.31	$^\circ\text{C/W}$
Thermal Resistance, Junction-to-Case	$R_{\theta(j-c)}$	Diode Part	-	-	1.2	$^\circ\text{C/W}$

KD221205A7
Dual Darlington Transistor Module
 50 Amperes/1200 Volts

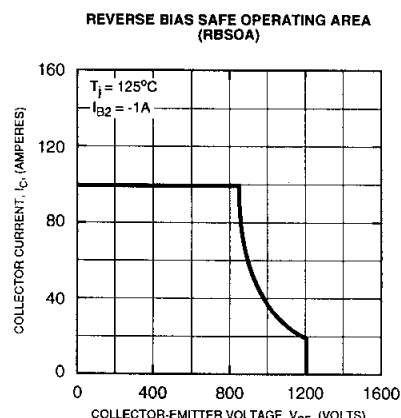
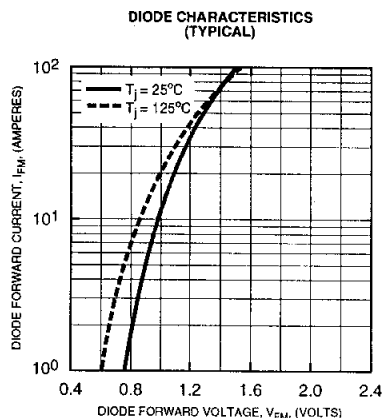
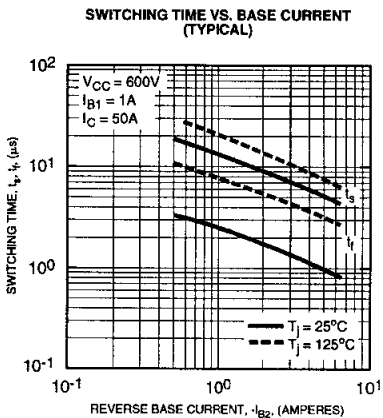
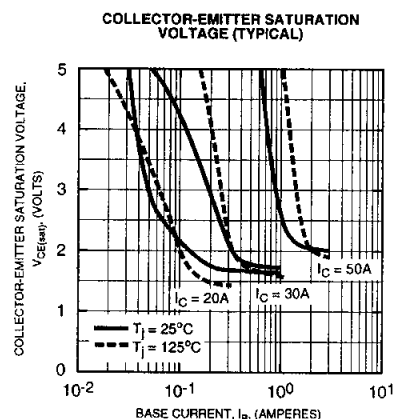
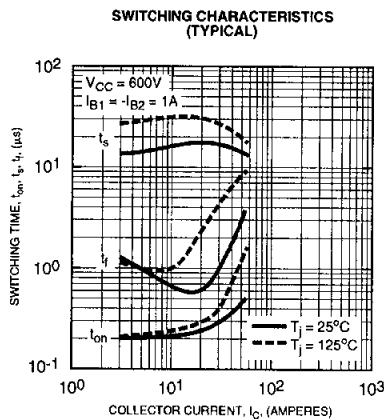
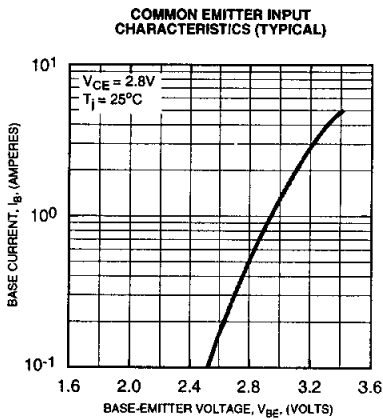
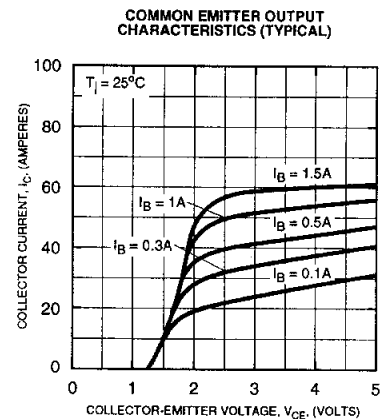
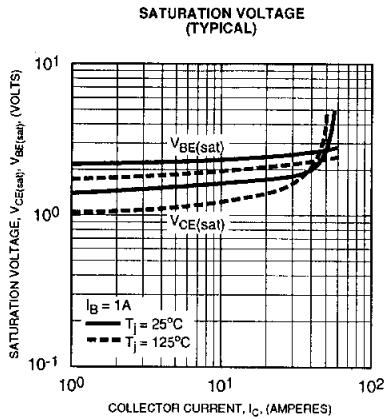
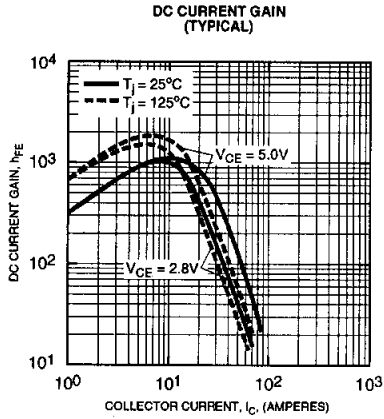

KD221205A7
Dual Darlington Transistor Module
 50 Amperes/1200 Volts

