

IRK.F82.. SERIES

**FAST THYRISTOR/ DIODE and
 THYRISTOR/THYRISTOR**

INT-A-pak™ Power Modules

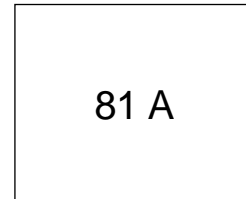

Features

- Fast turn-off thyristor
- Fast recovery diode
- High surge capability
- Electrically isolated baseplate
- 3000 V_{RMS} isolating voltage
- Industrial standard package
- UL E78996 approved

Description

These series of INT-A-pak modules are intended for applications such as self-commutated inverters, DC choppers, electronic welders, induction heating and others where fast switching characteristics are required.

Major Ratings and Characteristics

Parameters	IRK.F82..	Units
$I_{T(AV)}$	81	A
@ T_C	90	°C
$I_{T(RMS)}$	180	A
I_{TSM} @ 50Hz	2200	A
@ 60Hz	2300	A
I^2t @ 50Hz	24.2	KA ² s
@ 60Hz	22.1	KA ² s
$I^2\sqrt{t}$	242	KA ² √s
t_q range	10 and 15	μs
t_{rr}	2	μs
V_{DRM}/V_{RRM}	upto 800	V
T_J range	-40 to 125	°C

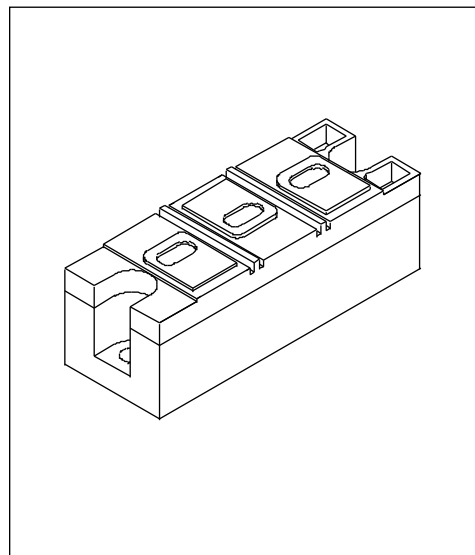

IRK.F82.. Series

Bulletin I27103 rev. A 09/97

International
 Rectifier

ELECTRICAL SPECIFICATIONS

Voltage Ratings

Type number	Voltage Code	V_{RRM}/V_{DRM} maximum repetitive peak reverse voltage V	V_{RSM} , maximum non-repetitive peak rev. voltage V	I_{RRM}/I_{DRM} max. @ $T_J = 125^\circ\text{C}$ mA
IRK.F82..	04	400	400	30
	08	800	800	

Current Carrying Capacity

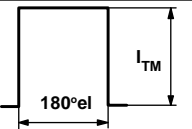
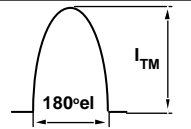
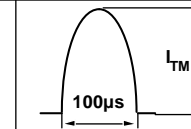
Frequency f				Units			
50Hz	160	265	250	400	2240	3100	A
400Hz	200	320	290	475	1070	1550	A
2500Hz	150	240	260	400	370	550	A
5000Hz	135	215	235	355	235	355	A
10000Hz	90	160	190	275	-	-	A
Recovery voltage Vr	50	50	50	50	50	50	V
Voltage before turn-on Vd	80% V_{DRM}		80% V_{DRM}		80% V_{DRM}		V
Rise of on-state current di/dt	50	50	-	-	-	-	A/ μs
Case temperature	90	60	90	60	90	60	$^\circ\text{C}$
Equivalent values for RC circuit	22 Ω /0.15 μF		22 Ω /0.15 μF		22 Ω /0.15 μF		

On-state Conduction

Parameter	IRK.F82..	Units	Conditions
$I_{T(AV)}$ Maximum average on-state current @ Case temperature	81	A	180° conduction, half sine wave
	90	$^\circ\text{C}$	
$I_{T(RMS)}$ Maximum RMS current	180	A	$T_C = 90^\circ\text{C}$, as AC switch
I_{TSM} Maximum peak, one-cycle, non-repetitive surge current	2200	A	t = 10ms No voltage reappplied
	2300		t = 8.3ms reappplied
	1850		t = 10ms 100% V_{RRM} reappplied
	1950		t = 8.3ms reappplied
I^2t Maximum I^2t for fusing	24.2	KA ² s	t = 10ms No voltage reappplied
	22.1		t = 8.3ms reappplied
	17.1		t = 10ms 100% V_{RRM} reappplied
	15.6		t = 8.3ms reappplied
$I^2\sqrt{t}$ Maximum $I^2\sqrt{t}$ for fusing	242	KA ² $\sqrt{\text{s}}$	t = 0 to 10ms, no voltage reappplied
$V_{T(TO)1}$ Low level value of threshold voltage	1.20	V	(16.7% $\times \pi \times I_{T(AV)} < I < \pi \times I_{T(AV)}$), $T_J = T_J$ max.
$V_{T(TO)2}$ High level value of threshold voltage	1.24		($I > \pi \times I_{T(AV)}$), $T_J = T_J$ max.
r_{t1} Low level value of on-state slope resistance	2.18	mW	(16.7% $\times \pi \times I_{T(AV)} < I < \pi \times I_{T(AV)}$), $T_J = T_J$ max.
r_{t2} High level value of on-state slope resistance	2.00		($I > \pi \times I_{T(AV)}$), $T_J = T_J$ max.
V_{TM} Maximum on-state voltage drop	1.96	V	$I_{pk} = 350\text{A}$, $T_J = T_J$ max., $t_p = 10\text{ms}$ sine pulse
I_H Maximum holding current	600	mA	$T_J = 25^\circ\text{C}$, $I_T > 30\text{A}$
I_L Typical latching current	1000	mA	$T_J = 25^\circ\text{C}$, $V_A = 12\text{V}$, $R_a = 6\Omega$, $I_g = 1\text{A}$

Switching

Parameter	IRK.F82..	Units	Conditions
di/dt Maximum non-repetitive rate of rise	800	A/μs	Gate drive 20V, 20Ω, tr ≤ 1ms, V _D = 80% V _{DRM} T _J = 25°C
t _{rr} Maximum recovery time	2	μs	I _{TM} = 350A, di/dt = -25A/μs, V _R = 50V, T _J = 25°C
t _q Maximum turn-off time	N 10	L 15 μs	I _{TM} = 350A, T _J = 125°C, di/dt = -25A/μs, V _R = 50V, dv/dt = 400V/μs linear to 80% V _{DRM}

Blocking

Parameter	IRK.F82..	Units	Conditions
dv/dt Maximum critical rate of rise of off-state voltage	1000	V/μs	T _J = 125°C., exponential to = 67% V _{DRM}
V _{INS} RMS isolation voltage	3000	V	50 Hz, circuit to base, T _J = 25°C, t = 1 s
I _{RRM} Maximum peak reverse and off-state leakage current I _{DRM}	30	mA	T _J = 125°C, rated V _{DRM} /V _{RRM} applied

Triggering

Parameter	IRK.F82..	Units	Conditions
P _{GM} Maximum peak gate power	40	W	f = 50 Hz, d% = 50
P _{G(AV)} Maximum peak average gate power	2	W	T _J = 125°C, f = 50Hz, d% = 50
I _{GM} Maximum peak positive gate current	5	A	T _J = 125°C, t _p ≤ 5ms
-V _{GM} Maximum peak negative gate voltage	5	V	
I _{GT} Max. DC gate current required to trigger	200	mA	T _J = 25°C, V _{ak} 12V, Ra = 6
V _{GT} DC gate voltage required to trigger	3	V	
I _{GD} DC gate current not to trigger	20	mA	T _J = 125°C, rated V _{DRM} applied
V _{GD} DC gate voltage not to trigger	0.25	V	

Thermal and Mechanical Specifications

Parameter	IRK.F82..	Units	Conditions
T _J Max. junction operating temperature range	- 40 to 125	°C	
T _{stg} Max. storage temperature range	- 40 to 150		
R _{thJC} Max. thermal resistance, junction to case	0.25	K/W	Per junction, DC operation
R _{thC-hs} Max. thermal resistance, case to heatsink	0.035	K/W	Mounting surface flat and greased Per module
T Mounting torque ± 10%	IAP to heatsink	4 - 6 (35 - 53)	A mounting compound is recommended. The torque should be rechecked after a period of 3 hours to allow for the spread of the compound. Use of cable lugs is not recommended, busbars should be used and restrained during tightening. Threads must be lubricated with a compound
	busbar to IAP	4 - 6 (35 - 53)	
wt Approximate weight	500 (17.8)	Nm (lb*in) g (oz)	

IRK.F82.. Series

Bulletin I27103 rev. A 09/97

International
IR Rectifier

ΔR_{thJC} Conduction

(The following table shows the increment of thermal resistance R_{thJC} when devices operate at different conduction angles than DC)

Conduction angle	Sinusoidal conduction	Rectangular conduction	Units	Conditions
180°	0.016	0.011	K/W	$T_J = 125^\circ\text{C}$
120°	0.019	0.020		
90°	0.024	0.026		
60°	0.035	0.037		
30°	0.060	0.060		

Ordering Information Table

Device Code									
IRK	T	F	8	2	-	08	H	L	N
①	②	③	④	⑤		⑥	⑦	⑧	⑧
1	- Module type								
2	- Circuit configuration								
3	- Fast SCR								
4	- Current rating: $I_{T(AV)} \times 10$ rounded								
5	- 1 = option with spacers and longer terminal screws 2 = option with standard terminal screws								
6	- Voltage code: Code $\times 100 = V_{RRM}$ (See Voltage Ratings Table)								
7	- dv/dt code: H $\leq 400\text{V}/\mu\text{s}$								
8	- t_q code: N $\leq 10\mu\text{s}$ L $\leq 15\mu\text{s}$								
9	- None = Standard devices N = Aluminum nitride substrate								

NOTE: To order the Optional Hardware see Bulletin I27900

Outline Table

- All dimensions in millimeters (inches)
- Dimensions are nominal
- Full engineering drawings are available on request
- UL identification number for gate and cathode wire: UL 1385
- UL identification number for package: UL 94V0

For all types	A	B	C	D	E
IRK...1	25 (0.98)	----	----	41 (1.61)	47 (1.85)
IRK...2	23 (0.91)	30 (1.18)	36 (1.42)	----	----

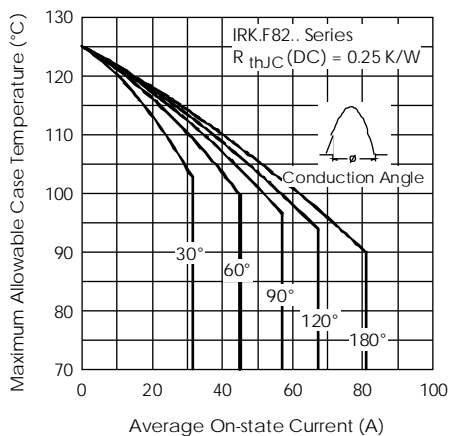

Fig. 1 - Current Ratings Characteristics

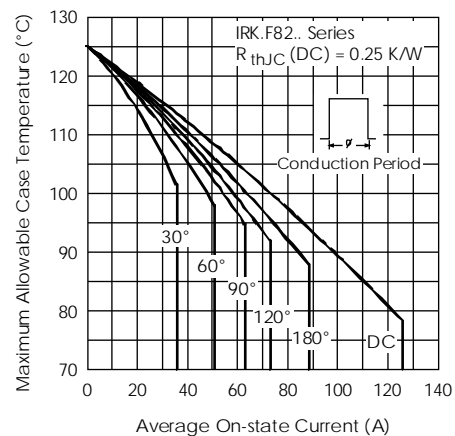

Fig. 2 - Current Ratings Characteristics

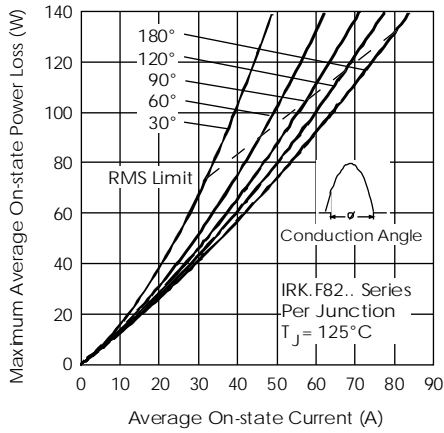

Fig. 3 - On-state Power Loss Characteristics

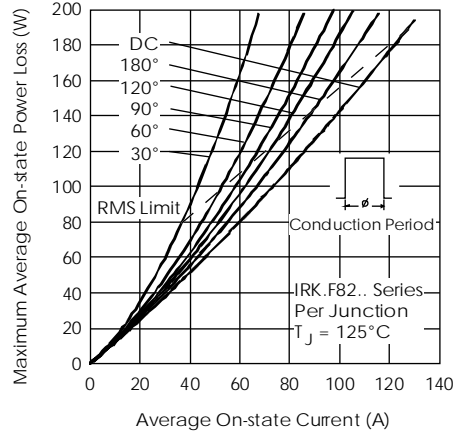

Fig. 4 - On-state Power Loss Characteristics

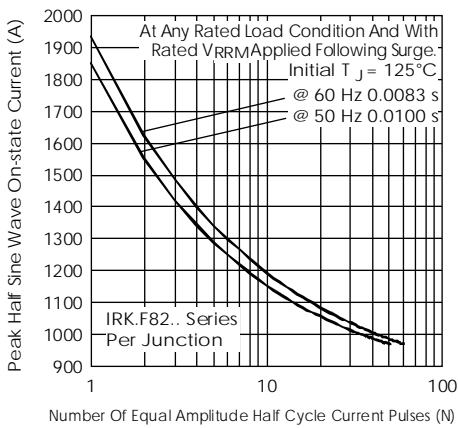

Fig. 5 - Maximum Non-Repetitive Surge Current

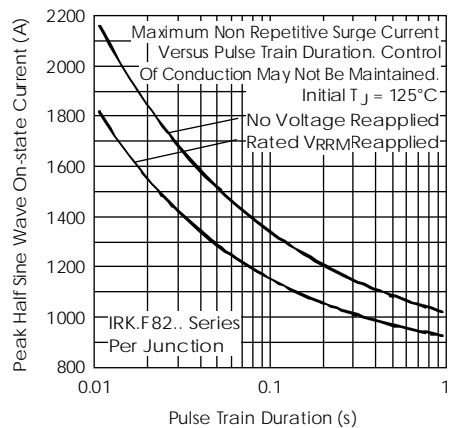

Fig. 6 - Maximum Non-Repetitive Surge Current

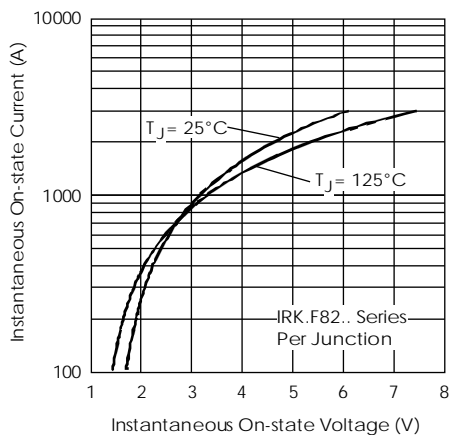

Fig. 7 - On-state Voltage Drop Characteristics

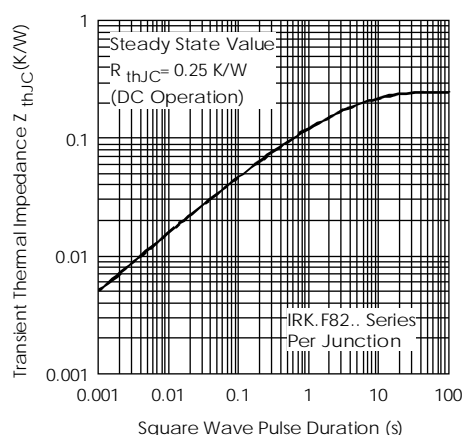

Fig. 8 - Thermal Impedance Z_{thJC} Characteristic

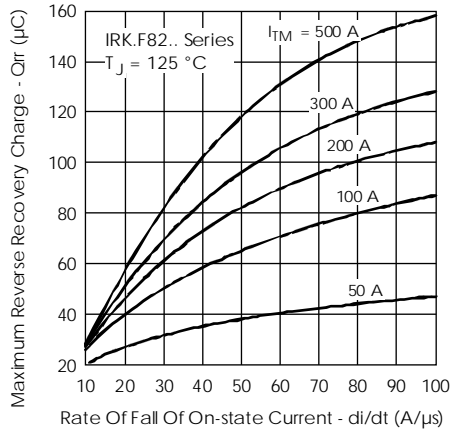

Fig. 9 - Reverse Recovery Charge Characteristic

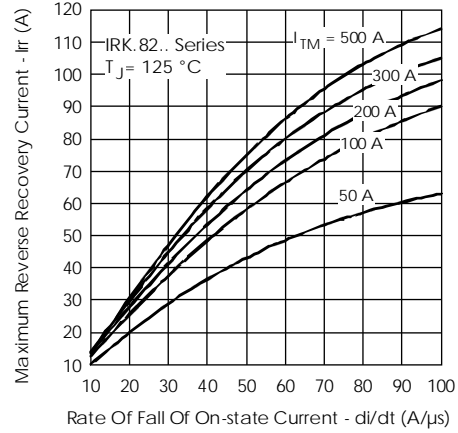

Fig. 10 - Reverse Recovery Current Characteristic

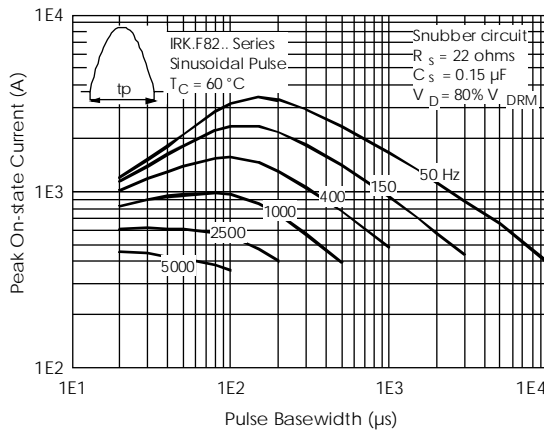

Fig. 11 - Frequency Characteristics

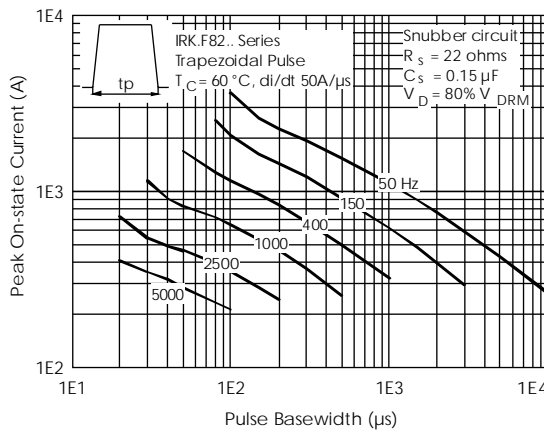
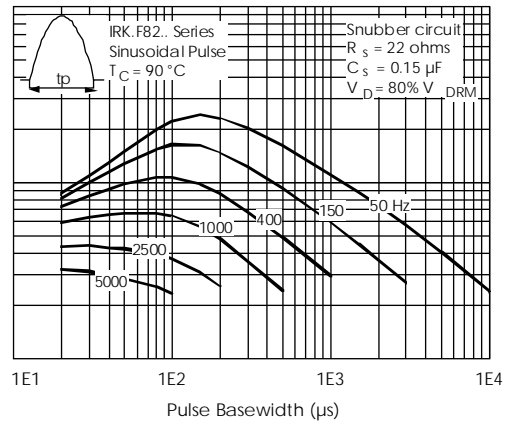
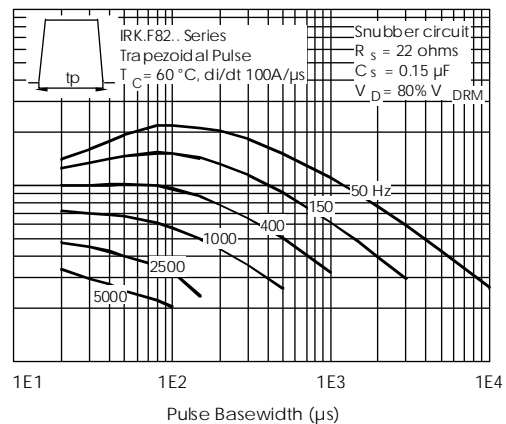

Fig. 12 - Frequency Characteristics



IRK.F82.. Series

Bulletin I27103 rev. A 09/97

International
IRF Rectifier

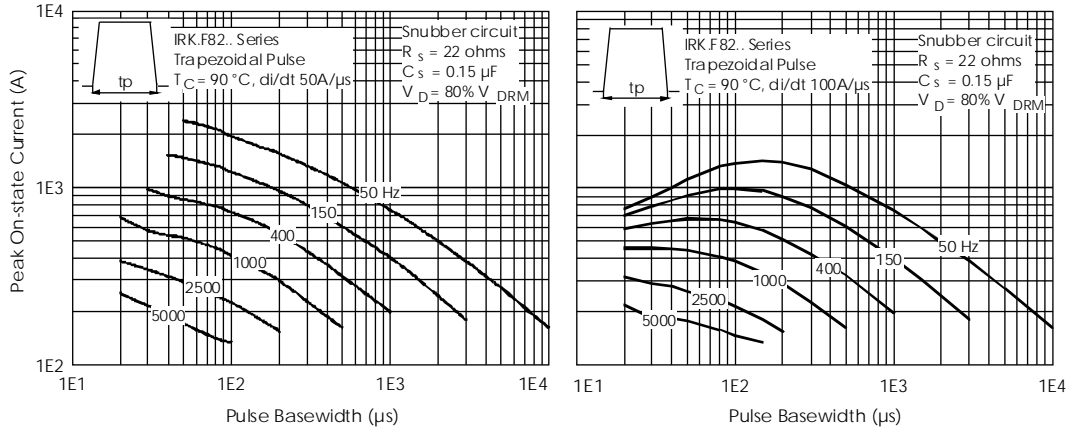

Fig. 13 - Frequency Characteristics

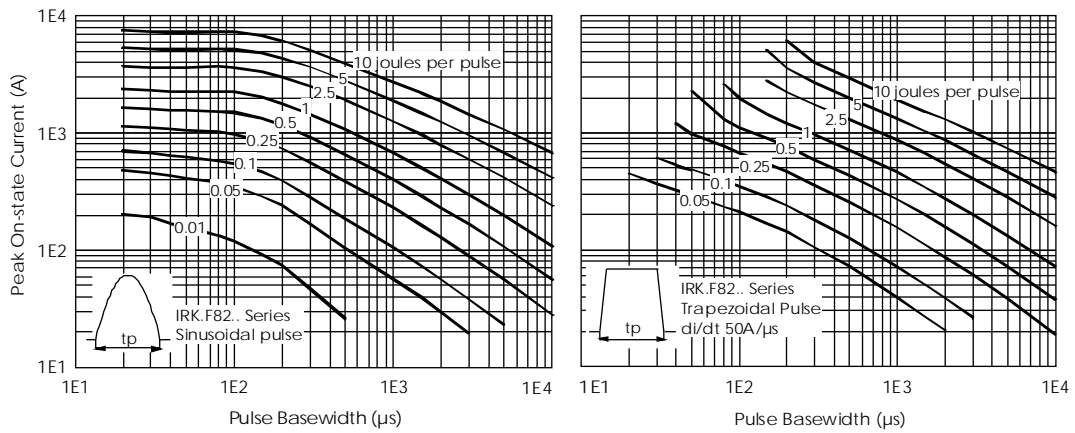

Fig. 14 - Maximum On-state Energy Power Loss Characteristics

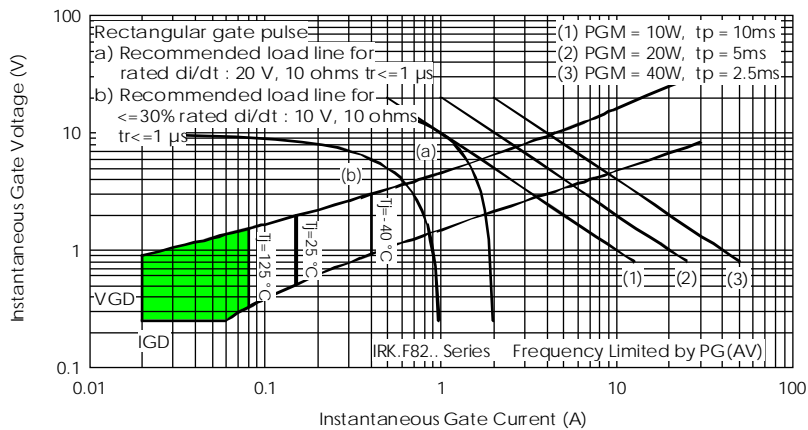

Fig. 15 - Gate Characteristics