

**STANDARD RECOVERY DIODES**

**MAGN-A-pak™ Power Modules**

**Features**

- High voltage
- Electrically isolated base plate
- 3000 V<sub>RMS</sub> isolating voltage
- Industrial standard package
- Simplified mechanical designs, rapid assembly
- High surge capability
- Large creepage distances
- UL E78996 approved 
- RoHS Compliant

**250A**  
**270A**  
**320A**

**Description**

This new IRK series of MAGN-A-paks uses high voltage power diodes in two basic configurations. The semiconductors are electrically isolated from the metal base, allowing common heatsinks and compact assemblies to be built. They can be interconnected to form single phase or three phase bridges and the single diode module can be used in conjunction with the thyristor modules as a freewheel diode. These modules are intended for general purpose applications such as battery chargers, welders and plating equipment and where high voltage and high current are required (motor drives, etc.).

**Major Ratings and Characteristics**

Parameters	IRK.250..	IRK.270..	IRK.320..	Units	
I <sub>F(AV)</sub>	250	270	320	A	
	@ T <sub>C</sub>	100	100	100	°C
I <sub>F(RMS)</sub>	393	424	502	A	
I <sub>FSM</sub>	@ 50Hz	7015	8920	10110	A
	@ 60Hz	7345	9430	10580	A
I <sup>2</sup> t	@ 50Hz	246	398	511	KA <sup>2</sup> s
	@ 60Hz	225	363	466	KA <sup>2</sup> s
I <sup>2</sup> √t	2460	3980	5110	KA <sup>2</sup> √s	
V <sub>RRM</sub>	Up to 2000	Up to 3000	Up to 2000	V	
T <sub>J</sub>	-40 to 150			°C	

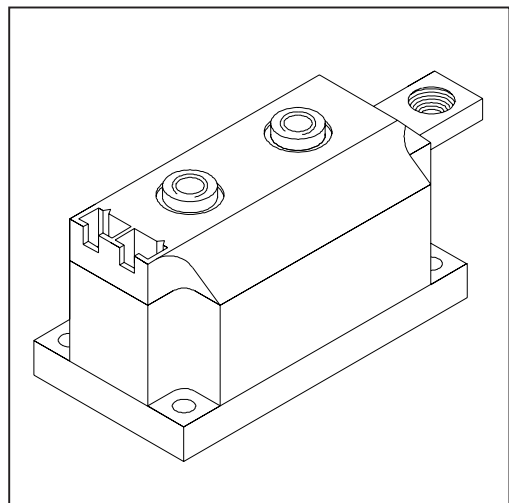

## ELECTRICAL SPECIFICATIONS

### Voltage Ratings

Type number	Voltage Code	$V_{RRM}$ , Maximum repetitive peak reverse voltage V	$V_{RSM}$ , Maximum non-repetitive peak reverse voltage V	$I_{RRM}$ Max @ 150°C mA
IRK.250- IRK.270- IRK.320-	04	400	500	50
	08	800	900	
	12	1200	1300	
	16	1600	1700	
	20	2000	2100	
IRK.320-	24	2400	2500	50
	30	3000	3100	

### Forward Conduction

Parameters	IRK.250	IRK.270	IRK.320	Units	Conditions
$I_{F(AV)}$ Maximum average forward current @ Case temperature	250	270	320	A	180° conduction, half sine wave
	100	100	100	°C	
$I_{F(RMS)}$ Maximum RMS forward current	393	424	502	A	as AC switch
$I_{FSM}$ Maximum peak, one-cycle forward, non-repetitive surge current	7015	8920	10110	A	t = 10ms No voltage
	7345	9340	10580		t = 8.3ms reapplied
	5900	7500	8500		t = 10ms 100% $V_{RRM}$
	6180	7850	8900		t = 8.3ms reapplied
$I^2t$ Maximum $I^2t$ for fusing	246	398	511	KA <sup>2</sup> s	t = 10ms No voltage
	225	363	466		t = 8.3ms reapplied
	174	281	361		t = 10ms 100% $V_{RRM}$
	159	257	330		t = 8.3ms reapplied
$I^2\sqrt{t}$ Maximum $I^2\sqrt{t}$ for fusing	2460	3980	5110	KA <sup>2</sup> √s	t = 0.1 to 10ms, no voltage reapplied
$V_{F(TO)1}$ Low level val. of threshold voltage	0.79	0.74	0.69	V	$(16.7\% \times \pi \times I_{F(AV)} < I < \pi \times I_{F(AV)})$ , $T_J = T_J \text{ max.}$
$V_{F(TO)2}$ High level val. of threshold voltage	0.92	0.87	0.86	V	$(I > \pi \times I_{F(AV)})$ , $T_J = T_J \text{ max.}$
$r_{t1}$ Low level forward slope resistance	0.63	0.94	0.59	mΩ	$(16.7\% \times \pi \times I_{F(AV)} < I < \pi \times I_{F(AV)})$ , $T_J = T_J \text{ max.}$
$r_{t2}$ High level forward slope resistance	0.49	0.81	0.44	mΩ	$(I > \pi \times I_{F(AV)})$ , $T_J = T_J \text{ max.}$
$V_{FM}$ Maximum forward voltage drop	1.29	1.48	1.28	V	$I_{FM} = \pi \times I_{F(AV)}$ , $T_J = T_J \text{ max.}$ , 180° conduction Av. power = $V_{F(TO)} \times I_{F(AV)} + r_f \times (I_{F(RMS)})^2$

### Blocking

Parameter	IRK.250/.270/.320	Units	Conditions
$I_{RRM}$ Max. peak reverse leakage current	50	mA	$T_J = 150^\circ\text{C}$
$V_{INS}$ RMS isolation voltage	3000	V	50Hz, circuit to base, all terminals shorted, t = 1sec

**Thermal and Mechanical Specifications**

Parameter	IRK.250 / .270 / .320	Units	Conditions
T <sub>J</sub> Max. junction operating temperature range	-40 to 150	°C	
T <sub>stg</sub> Max. storage temperature range		-40 to 150 °C	
R <sub>thJC</sub> Max. thermal resistance, junction to case	0.16 0.125 0.125	K/W	Per junction, DC operation
R <sub>thCS</sub> Max. thermal resistance, case to heatsink	0.035	K/W	Mounting surface flat, smooth and greased
T Mounting torque ±10% MAP to heatsink busbar to MAP	4 to 6 8 to 10	Nm	Per module A mounting compound is recommended and the torque should be rechecked after a period of 3 hours to allow for the spread of the compound
wt Approximate weight	800 (30)	g (oz)	

**ΔR Conduction (per Junction)**

(The following table shows the increment of thermal resistance R<sub>thJC</sub> when devices operate at different conduction angles than DC)

Devices	Sinusoidal conduction @ T <sub>J</sub> max.					Rectangular conduction @ T <sub>J</sub> max.					Units
	180°	120°	90°	60°	30°	180°	120°	90°	60°	30°	
IRK.250-	0.009	0.010	0.014	0.020	0.032	0.007	0.011	0.015	0.021	0.033	K/W
IRK.270-	0.008	0.012	0.014	0.020	0.032	0.007	0.011	0.015	0.020	0.033	
IRK.320-	0.008	0.010	0.013	0.020	0.032	0.007	0.011	0.015	0.020	0.033	

**Ordering Information Table**

**Device Code**

<b>IRK</b>	<b>D</b>	<b>320</b>	<b>-</b>	<b>24</b>
①	②	③		④

- 1** - Module type
- 2** - Circuit configuration
- 3** - Current rating: I<sub>F(AV)</sub> x 10 rounded
- 4** - Voltage code: Code x 100 = V<sub>RRM</sub> (see Voltage Rating Table)

Outline Table

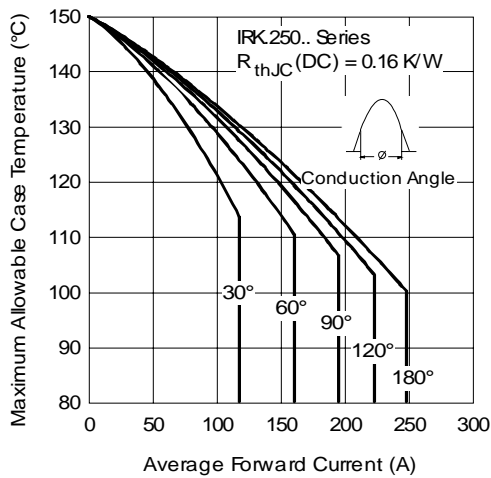
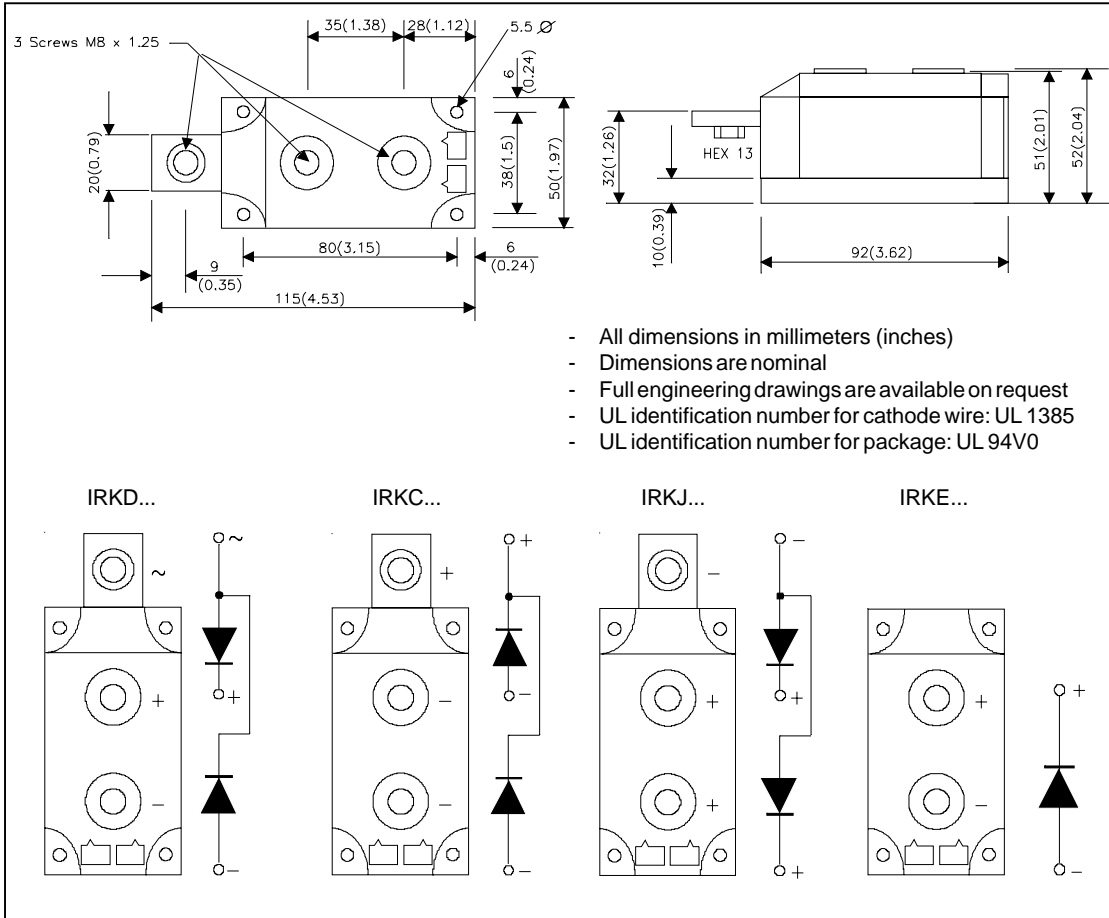

Fig. 1 - Current Ratings Characteristics

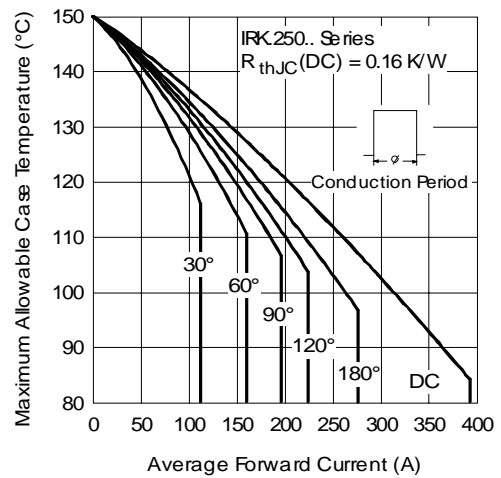

Fig. 2 - Current Ratings Characteristics

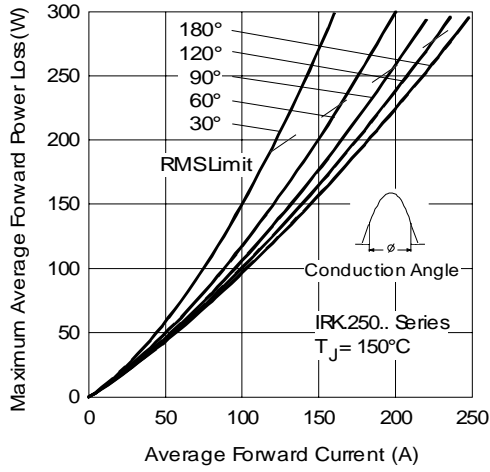

Fig. 3 - Forward Power Loss Characteristics

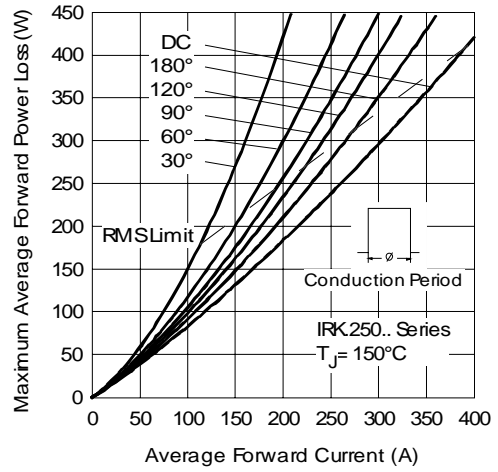

Fig. 4 - Forward Power Loss Characteristics

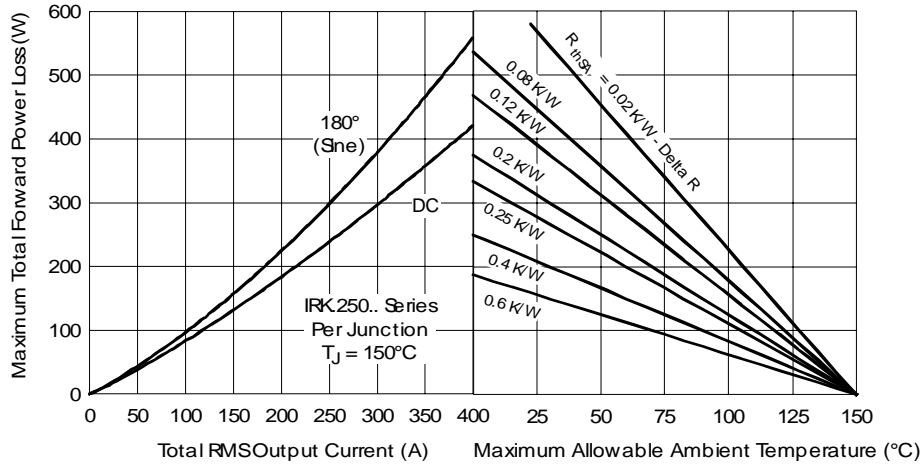

Fig. 5 - Forward Power Loss Characteristics

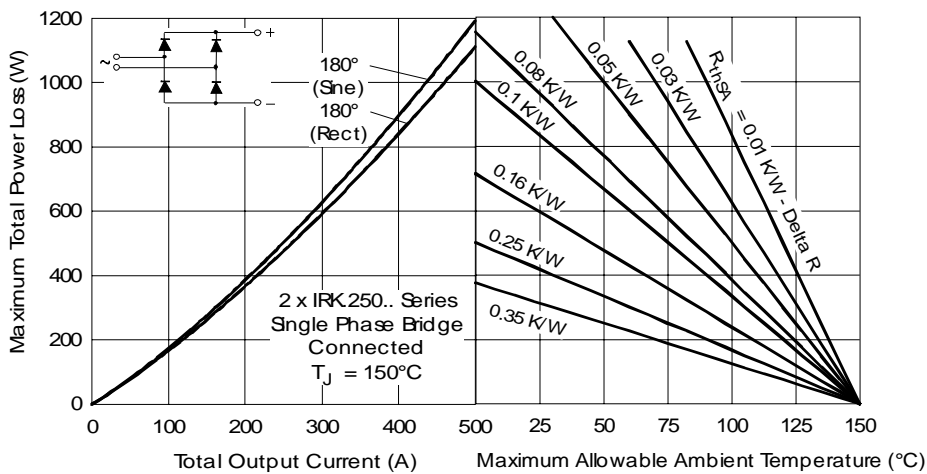

Fig. 6 - Forward Power Loss Characteristics

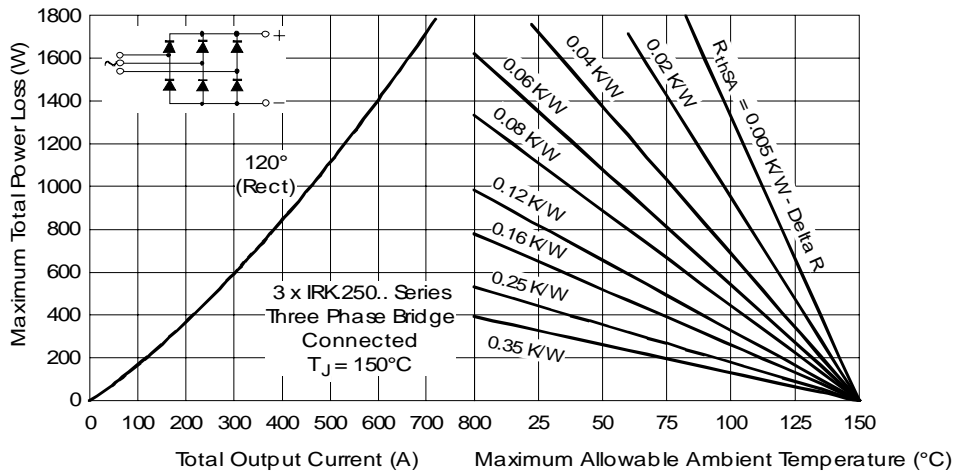

Fig. 7 - Forward Power Loss Characteristics

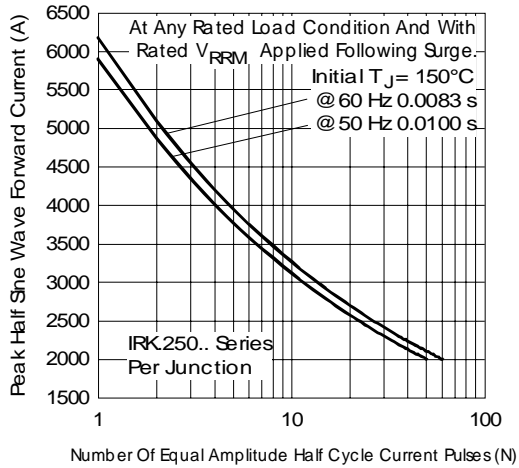

Fig. 8 - Maximum Non-Repetitive Surge Current

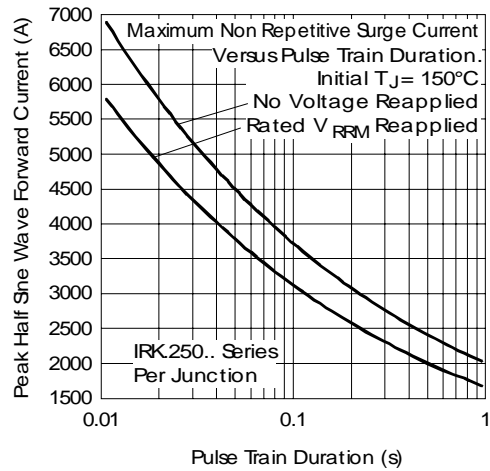

Fig. 9 - Maximum Non-Repetitive Surge Current

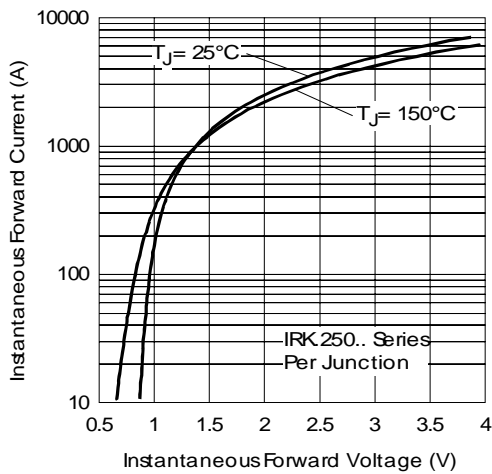

Fig. 10 - Forward Voltage Drop Characteristics

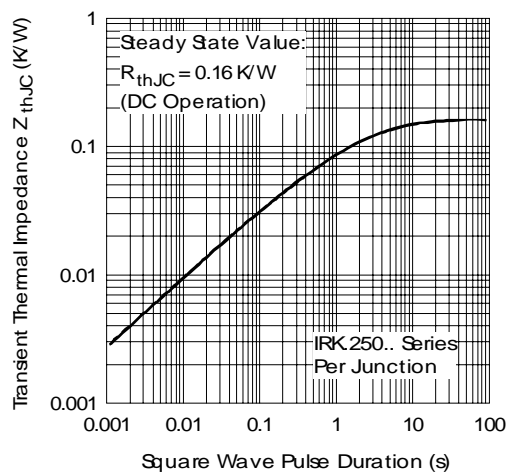

Fig. 11 - Thermal Impedance  $Z_{thJC}$  Characteristics

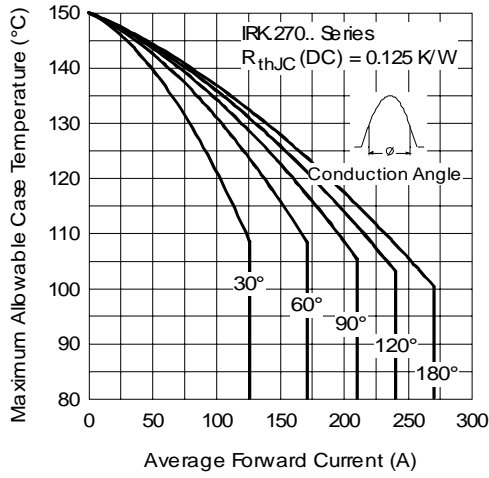

Fig. 12 - Current Ratings Characteristics

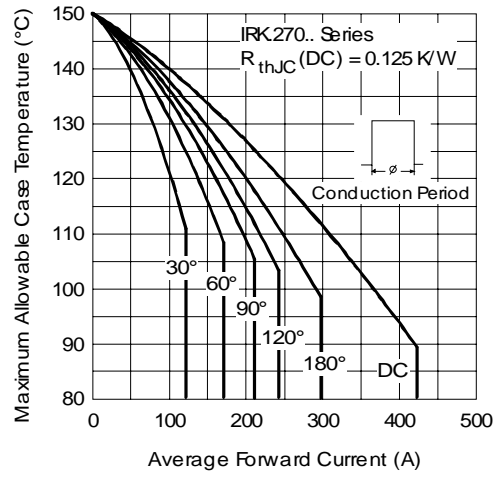

Fig. 13 - Current Ratings Characteristics

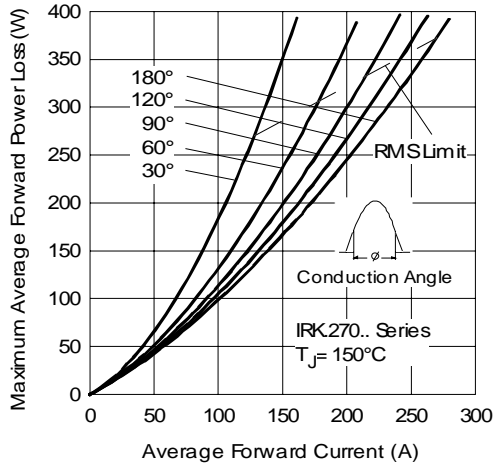

Fig. 14 - Forward Power Loss Characteristics

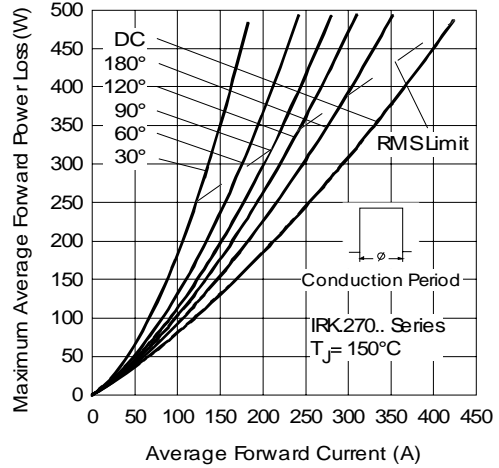

Fig. 15 - Forward Power Loss Characteristics

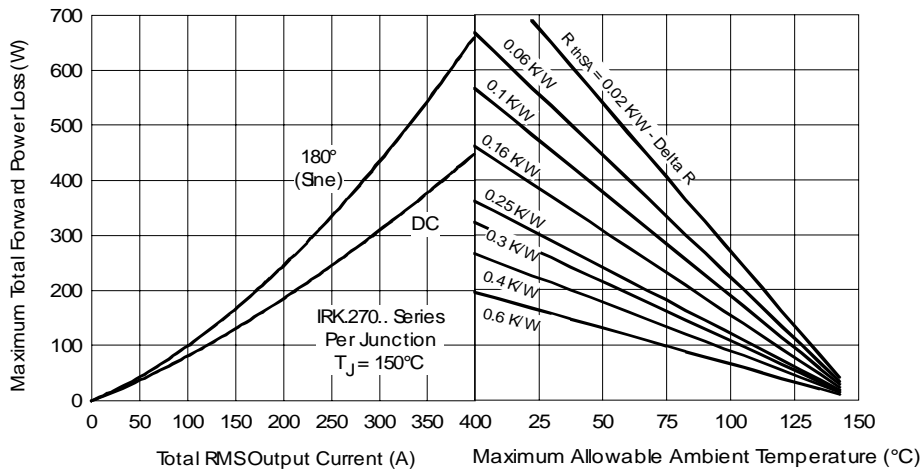

Fig. 16 - Forward Power Loss Characteristics

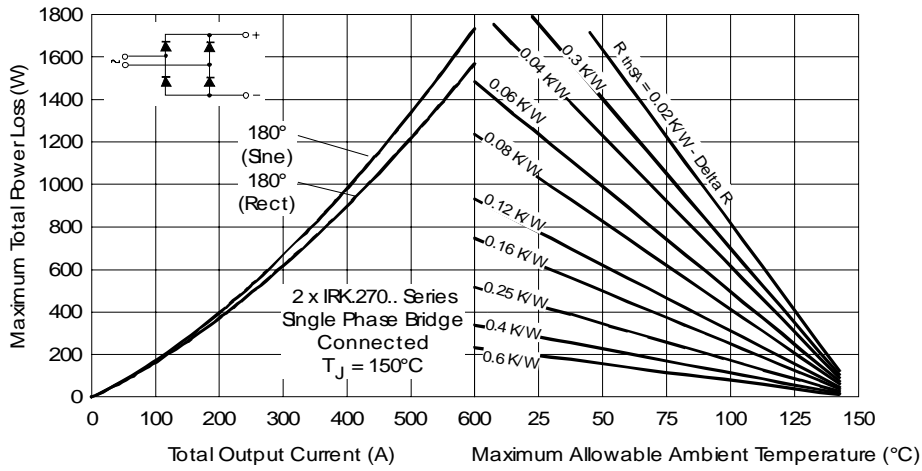

Fig. 17 - Forward Power Loss Characteristics

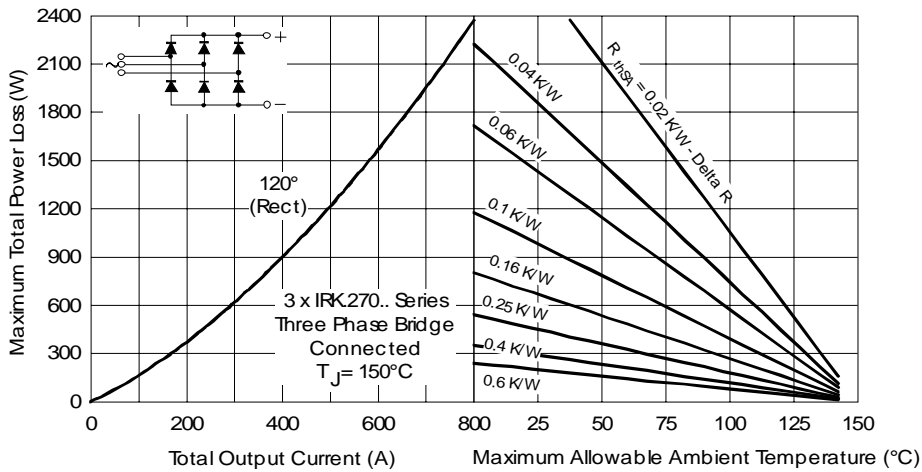

Fig. 18 - Forward Power Loss Characteristics

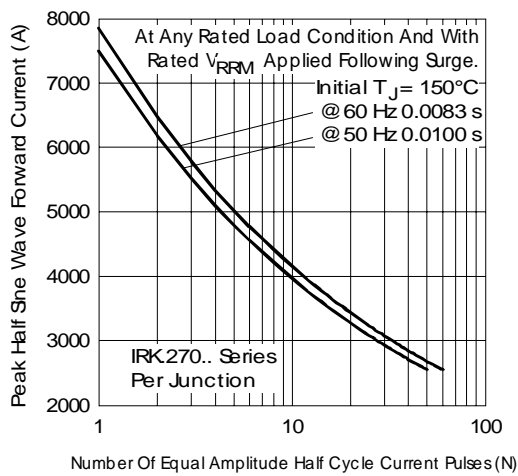

Fig. 19 - Maximum Non-Repetitive Surge Current

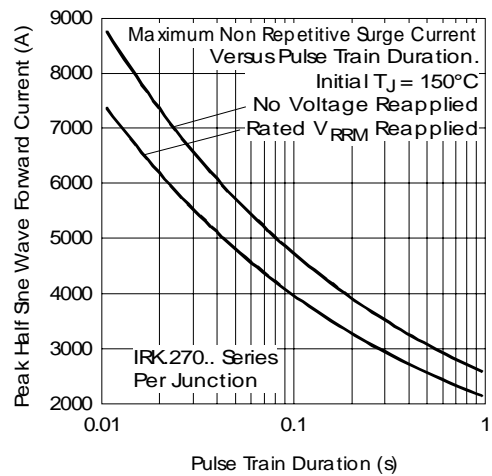

Fig. 20 - Maximum Non-Repetitive Surge Current



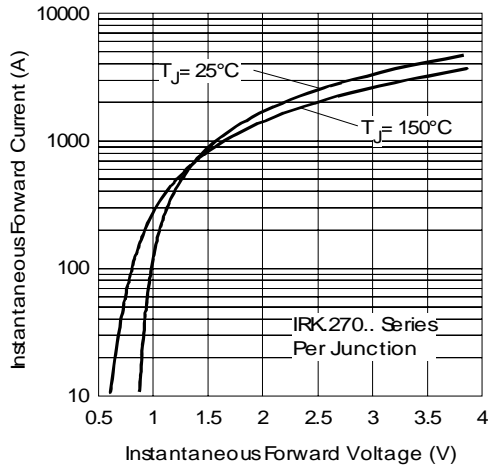

Fig. 21 - Forward Voltage Drop Characteristics

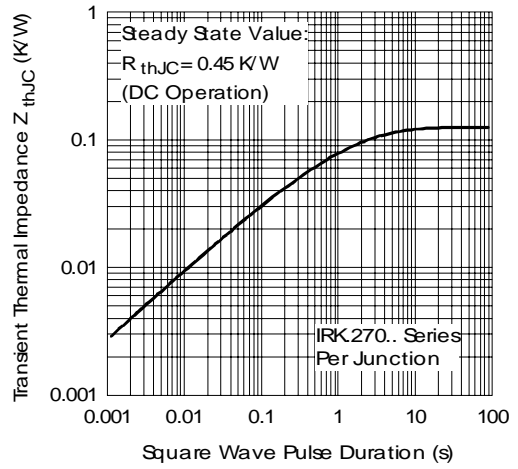

Fig. 22 - Thermal Impedance  $Z_{thJC}$  Characteristics

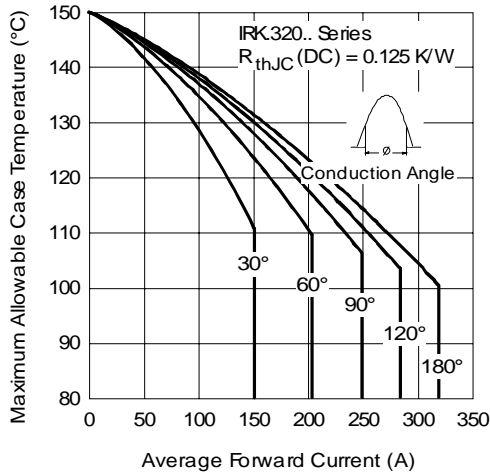

Fig. 23 - Current Ratings Characteristics

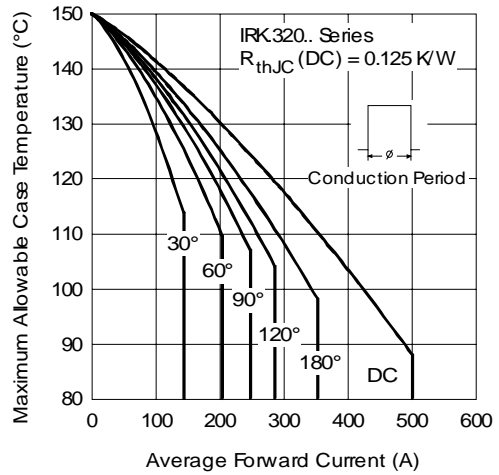

Fig. 24 - Current Ratings Characteristics

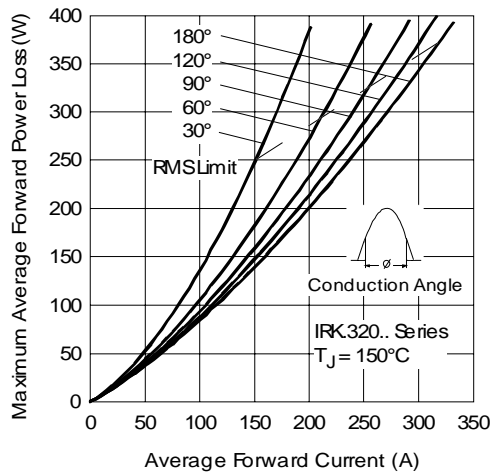

Fig. 25 - Forward Power Loss Characteristics

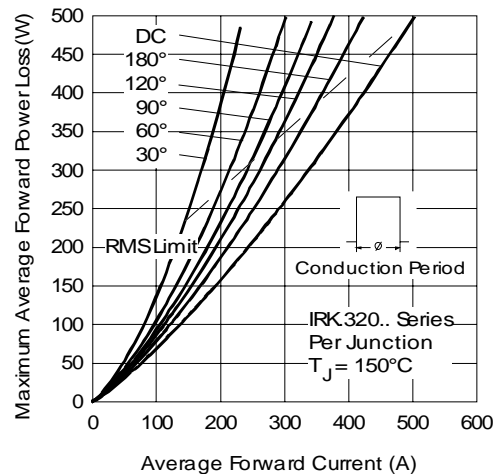

Fig. 26 - Forward Power Loss Characteristics

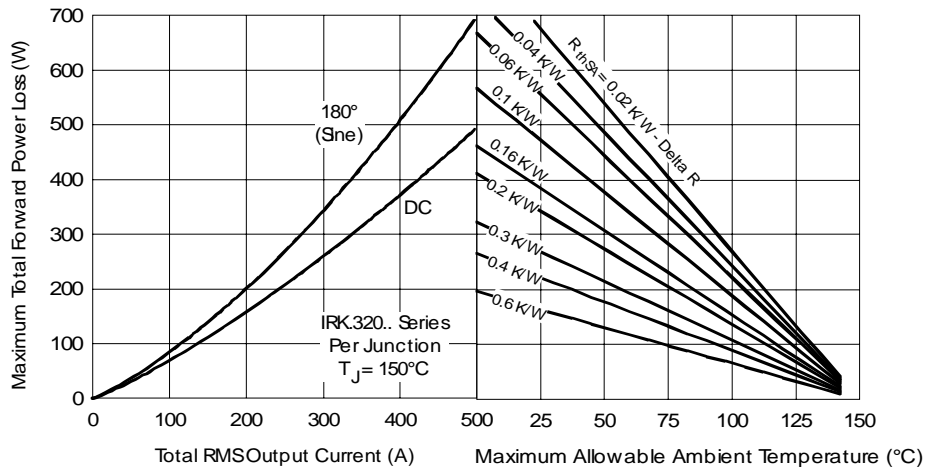

Fig. 27 - Forward Power Loss Characteristics

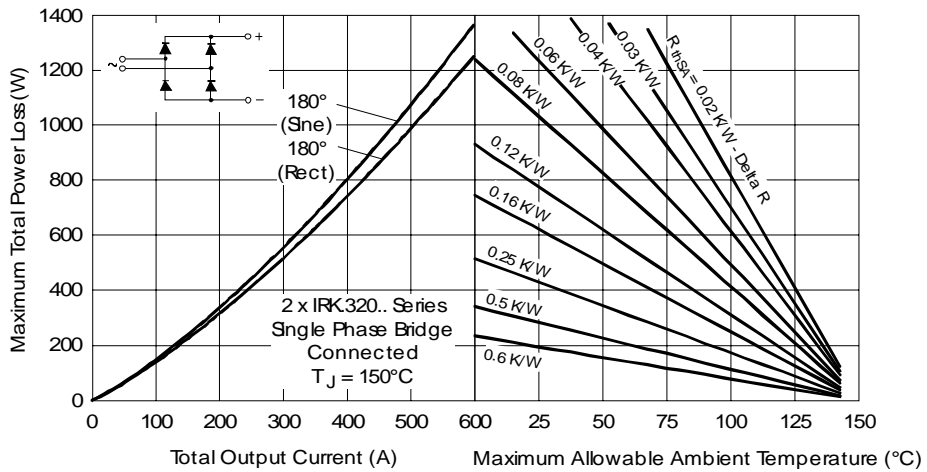

Fig. 28 - Forward Power Loss Characteristics

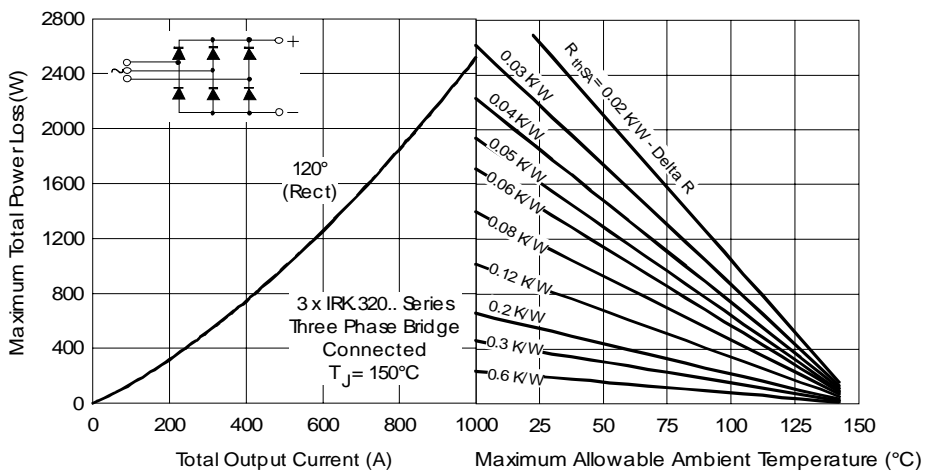

Fig. 29 - Forward Power Loss Characteristics

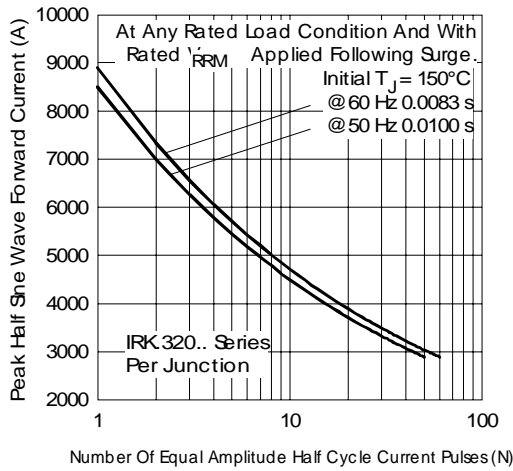

Fig. 30 - Maximum Non-Repetitive Surge Current

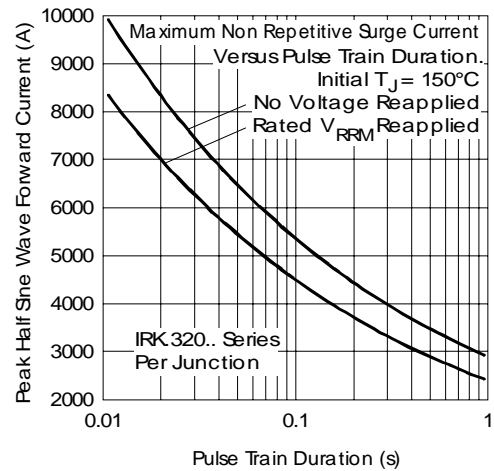

Fig. 31 - Maximum Non-Repetitive Surge Current

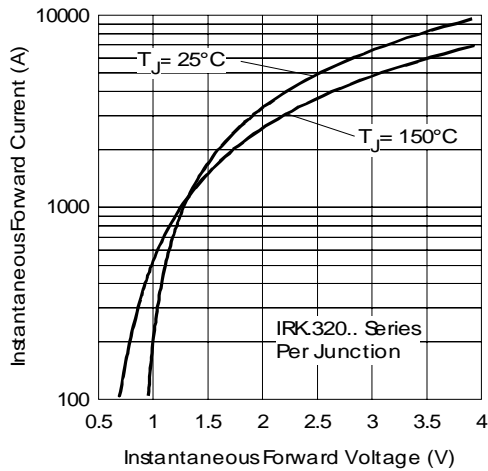

Fig. 32 - Forward Voltage Drop Characteristics

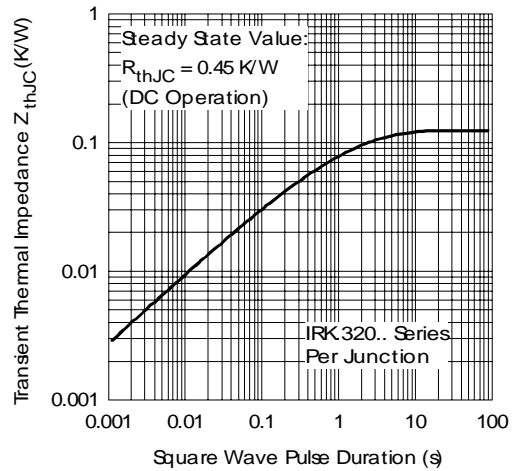

Fig. 33 - Thermal Impedance  $Z_{thJC}$  Characteristics

Data and specifications subject to change without notice. This product has been designed and qualified for Industrial Level. Qualification Standards can be found on IR's Web site.