

**9A, 200V, 0.400 Ohm, N-Channel Power MOSFETs**

These are N-Channel enhancement mode silicon gate power field effect transistors. They are advanced power MOSFETs designed, tested, and guaranteed to withstand a specified level of energy in the breakdown avalanche mode of operation. All of these power MOSFETs are designed for applications such as switching regulators, switching converters, motor drivers, relay drivers, and drivers for high power bipolar switching transistors requiring high speed and low gate drive power. These types can be operated directly from integrated circuits.

Formerly developmental type TA17412.

**Ordering Information**

PART NUMBER	PACKAGE	BRAND
IRF630	TO-220AB	IRF630
RF1S630SM	TO-263AB	RF1S630

NOTE: When ordering, use the entire part number. Add the suffix 9A to obtain the TO-263AB variant in the tape and reel, i.e., RF1S630SM9A.

**Features**

- 9A, 200V
- $r_{DS(ON)} = 0.400\Omega$
- Single Pulse Avalanche Energy Rated
- SOA is Power Dissipation Limited
- Nanosecond Switching Speeds
- Linear Transfer Characteristics
- High Input Impedance
- Related Literature
  - TB334 "Guidelines for Soldering Surface Mount Components to PC Boards"

**Symbol**

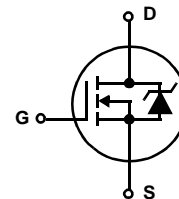

**Packaging**

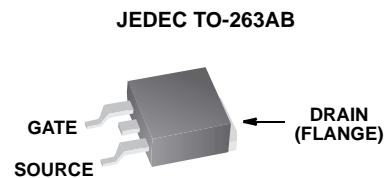
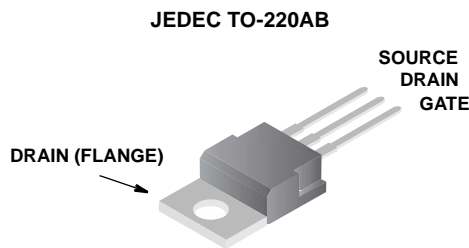

# IRF630, RF1S630SM

## Absolute Maximum Ratings $T_C = 25^\circ\text{C}$ , Unless Otherwise Specified

	IRF630, RF1S630SM	UNITS
Drain to Source Voltage (Note 1) . . . . .	200	V
Drain to Gate Voltage ( $R_{GS} = 20\text{k}\Omega$ ) (Note 1) . . . . .	200	V
Continuous Drain Current . . . . .	9	A
$T_C = 100^\circ\text{C}$ . . . . .	6	A
Pulsed Drain Current (Note 3) . . . . .	36	A
Gate to Source Voltage . . . . .	$\pm 20$	V
Maximum Power Dissipation . . . . .	75	W
Linear Derating Factor . . . . .	0.6	W/ $^\circ\text{C}$
Single Pulse Avalanche Energy Rating (Note 4) . . . . .	150	mJ
Operating and Storage Temperature . . . . .	-55 to 150	$^\circ\text{C}$
Maximum Temperature for Soldering		
Leads at 0.063in (1.6mm) from Case for 10s. . . . .	300	$^\circ\text{C}$
Package Body for 10s, See Techbrief 334 . . . . .	260	$^\circ\text{C}$

CAUTION: Stresses above those listed in "Absolute Maximum Ratings" may cause permanent damage to the device. This is a stress only rating and operation of the device at these or any other conditions above those indicated in the operational sections of this specification is not implied.

**NOTE:**

1.  $T_J = 25^\circ\text{C}$  to  $125^\circ\text{C}$ .

## Electrical Specifications $T_C = 25^\circ\text{C}$ , Unless Otherwise Specified

PARAMETER	SYMBOL	TEST CONDITIONS	MIN	TYP	MAX	UNITS
Drain to Source Breakdown Voltage	$BV_{DSS}$	$I_D = 250\mu\text{A}$ , $V_{GS} = 0\text{V}$ (Figure 10)	200	-	-	V
Gate Threshold Voltage	$V_{GS(TH)}$	$V_{GS} = V_{DS}$ , $I_D = 250\mu\text{A}$	2	-	4	V
Zero Gate Voltage Drain Current	$I_{DSS}$	$V_{DS} = \text{Rated } BV_{DSS}$ , $V_{GS} = 0\text{V}$	-	-	25	$\mu\text{A}$
		$V_{DS} = 0.8 \times \text{Rated } BV_{DSS}$ , $V_{GS} = 0\text{V}$ , $T_J = 125^\circ\text{C}$	-	-	250	$\mu\text{A}$
On-State Drain Current (Note 2)	$I_{D(ON)}$	$V_{DS} > I_{D(ON)} \times r_{DS(ON)MAX}$ , $V_{GS} = 10\text{V}$	9	-	-	A
Gate to Source Leakage Current	$I_{GSS}$	$V_{GS} = \pm 20\text{V}$	-	-	$\pm 100$	nA
Drain to Source On Resistance (Note 2)	$r_{DS(ON)}$	$I_D = 5\text{A}$ , $V_{GS} = 10\text{V}$ (Figure 8, 9)	-	0.25	0.4	$\Omega$
Forward Transconductance (Note 2)	$g_{fs}$	$V_{DS} > I_{D(ON)} \times r_{DS(ON)MAX}$ , $I_D = 5\text{A}$ (Figure 12)	3	4.8	-	S
Turn-On Delay Time	$t_{d(ON)}$	$V_{DD} = 90\text{V}$ , $I_D \approx 9\text{A}$ , $R_{GS} = 9.1\Omega$ , $V_{GS} = 10\text{V}$ $R_L = 9.6\Omega$ MOSFET Switching Times are Essentially Independent of Operating Temperature	-	-	30	ns
Rise Time	$t_r$		-	-	50	ns
Turn-Off Delay Time	$t_{d(OFF)}$		-	-	50	ns
Fall Time	$t_f$		-	-	40	ns
Total Gate Charge (Gate to Source + Gate to Drain)	$Q_{g(TOT)}$	$V_{GS} = 10\text{V}$ , $I_D = 9\text{A}$ , $V_{DS} = 0.8 \times \text{Rated } BV_{DSS}$ $I_{g(REF)} = 1.5\text{mA}$ (Figure 14) Gate Charge is Essentially Independent of Operating Temperature	-	19	30	nC
Gate to Source Charge	$Q_{gs}$		-	10	-	nC
Gate to Drain "Miller" Charge	$Q_{gd}$		-	9	-	nC
Input Capacitance	$C_{ISS}$	$V_{DS} = 25\text{V}$ , $V_{GS} = 0\text{V}$ , $f = 1\text{MHz}$ (Figure 11)	-	600	-	pF
Output Capacitance	$C_{OSS}$		-	250	-	pF
Reverse Transfer Capacitance	$C_{RSS}$		-	80	-	pF
Internal Drain Inductance	$L_D$	Measured From the Contact Screw on Tab to Center of Die	-	3.5	-	nH
		Measured From the Drain Lead, 6mm (0.25in) From Package to Center of Die	-	4.5	-	nH
Internal Source Inductance	$L_S$	Measured From the Source Lead, 6mm (0.25in) From Header to Source Bonding Pad	-	7.5	-	nH
Thermal Resistance Junction to Case	$R_{\theta JC}$		-	-	1.67	$^\circ\text{C/W}$
Thermal Resistance Junction to Ambient	$R_{\theta JA}$	Free Air Operation	-	-	80	$^\circ\text{C/W}$

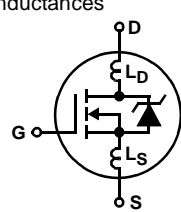

Source to Drain Diode Specifications

PARAMETER	SYMBOL	TEST CONDITIONS	MIN	TYP	MAX	UNITS
Continuous Source to Drain Current	$I_{SD}$	Modified MOSFET Symbol Showing the Integral Reverse P-N Junction Diode	-	-	9	A
Pulse Source to Drain Current (Note 3)	$I_{SDM}$		-	-	36	A
Source to Drain Diode Voltage (Note 2)	$V_{SD}$	$T_J = 25^{\circ}\text{C}$ , $I_{SD} = 9\text{A}$ , $V_{GS} = 0\text{V}$ (Figure 13)	-	-	2	V
Reverse Recovery Time	$t_{rr}$	$T_J = 150^{\circ}\text{C}$ , $I_{SD} = 9\text{A}$ , $dI_{SD}/dt = 100\text{A}/\mu\text{s}$	-	450	-	ns
Reverse Recovery Charge	$Q_{RR}$	$T_J = 150^{\circ}\text{C}$ , $I_{SD} = 9\text{A}$ , $dI_{SD}/dt = 100\text{A}/\mu\text{s}$	-	3	-	$\mu\text{C}$

NOTES:

2. Pulse Test: Pulse width  $\leq 300\mu\text{s}$ , Duty Cycle  $\leq 2\%$ .
3. Repetitive rating: Pulse width limited by maximum junction temperature. See Transient Thermal Impedance curve (Figure 3).
4.  $V_{DD} = 20\text{V}$ , starting  $T_J = 25^{\circ}\text{C}$ ,  $L = 3.37\text{mH}$ ,  $R_G = 50\Omega$ , peak  $I_{AS} = 9\text{A}$ .

Typical Performance Curves Unless Otherwise Specified

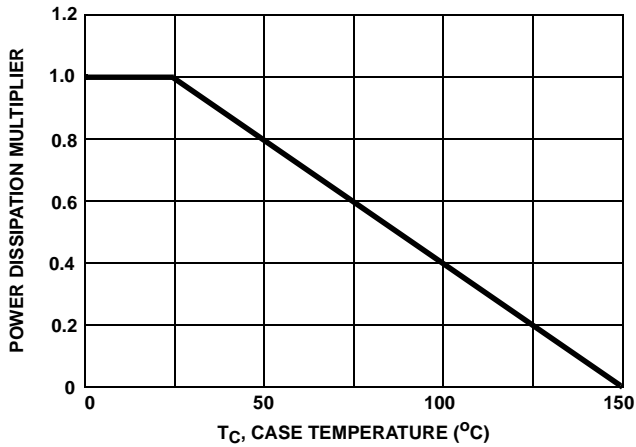

FIGURE 1. NORMALIZED POWER DISSIPATION vs CASE TEMPERATURE

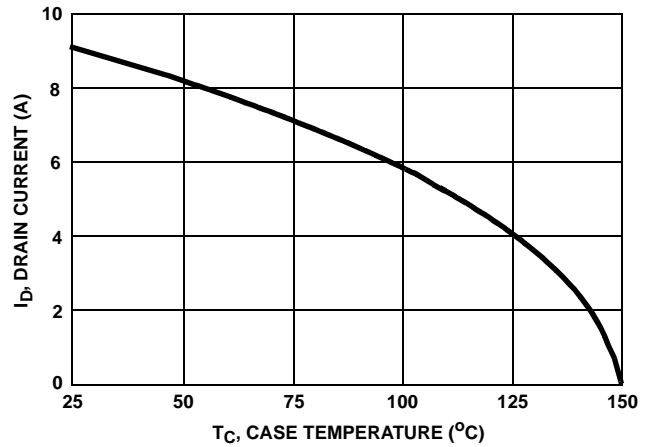

FIGURE 2. MAXIMUM CONTINUOUS DRAIN CURRENT vs CASE TEMPERATURE

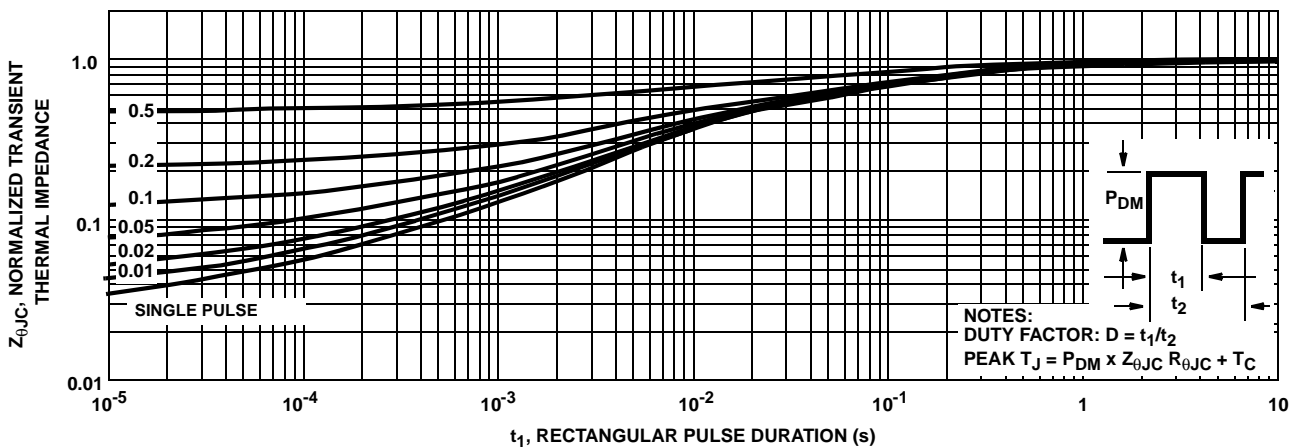

FIGURE 3. NORMALIZED TRANSIENT THERMAL IMPEDANCE

Typical Performance Curves Unless Otherwise Specified (Continued)

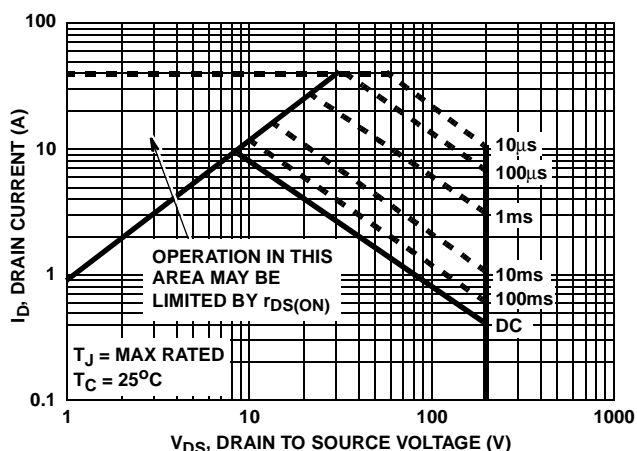

FIGURE 4. FORWARD BIAS SAFE OPERATING AREA

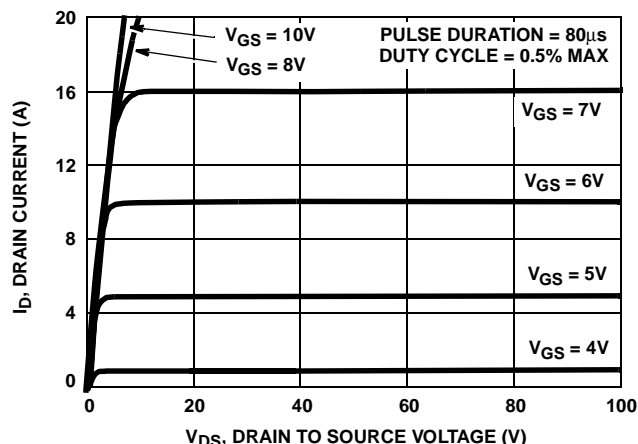

FIGURE 5. OUTPUT CHARACTERISTICS

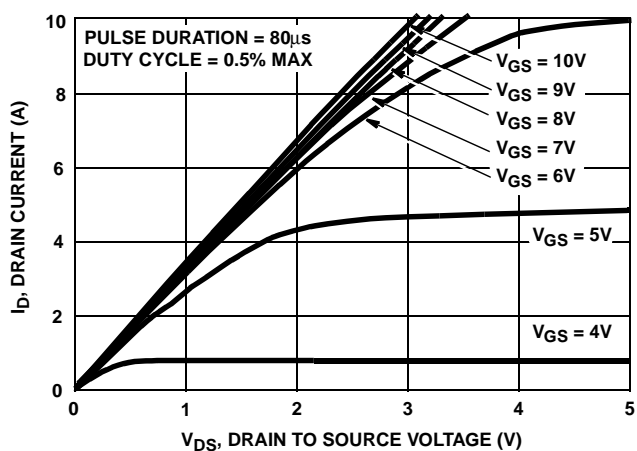

FIGURE 6. SATURATION CHARACTERISTICS

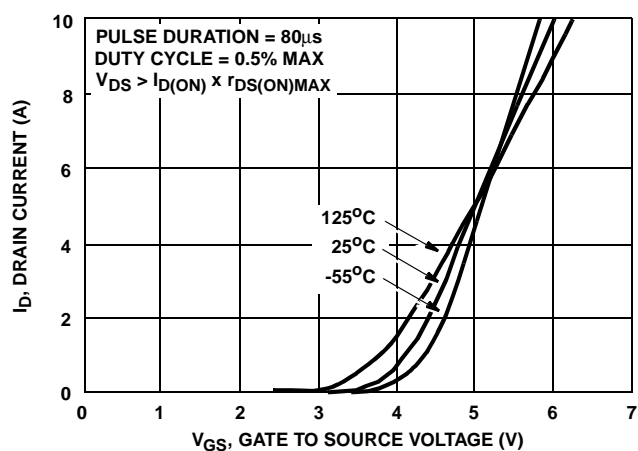

FIGURE 7. TRANSFER CHARACTERISTICS

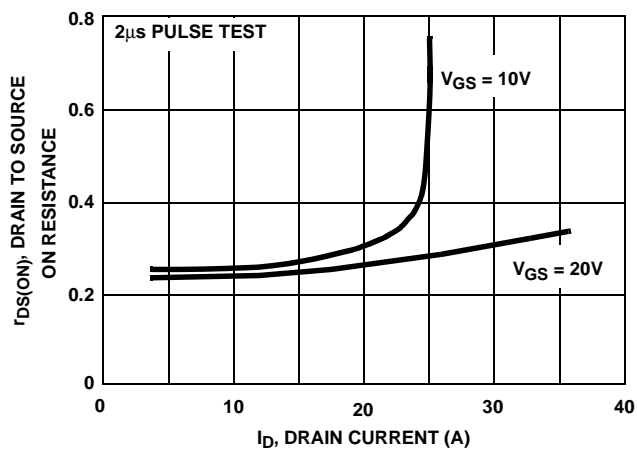

FIGURE 8. DRAIN TO SOURCE ON RESISTANCE vs GATE VOLTAGE AND DRAIN CURRENT

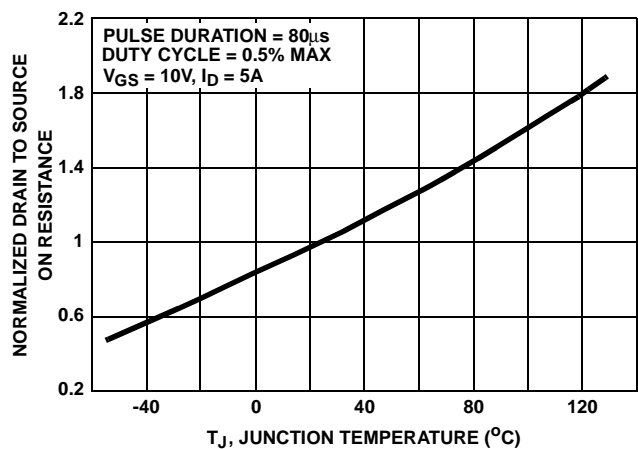

FIGURE 9. NORMALIZED DRAIN TO SOURCE ON RESISTANCE vs JUNCTION TEMPERATURE

Typical Performance Curves Unless Otherwise Specified (Continued)

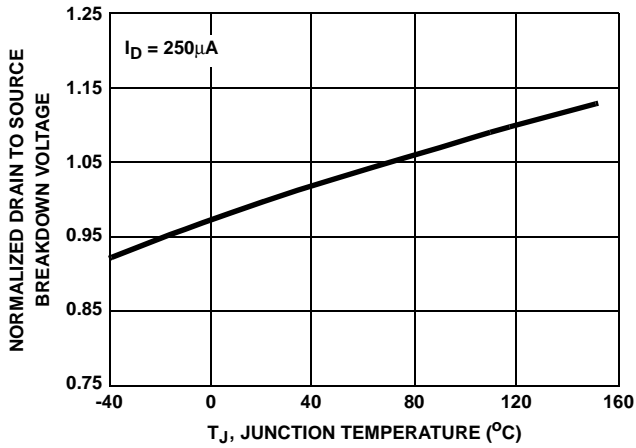

FIGURE 10. NORMALIZED DRAIN TO SOURCE BREAKDOWN VOLTAGE vs JUNCTION TEMPERATURE

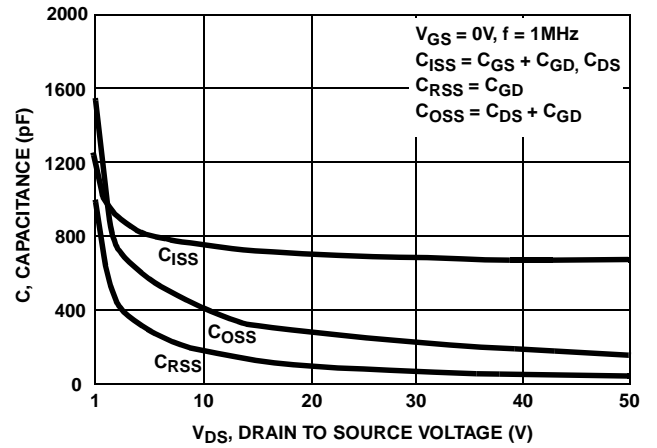

FIGURE 11. CAPACITANCE vs DRAIN TO SOURCE VOLTAGE

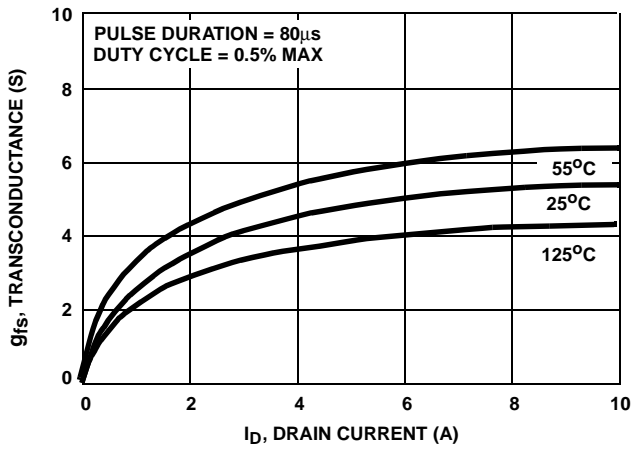

FIGURE 12. TRANSCONDUCTANCE vs DRAIN CURRENT

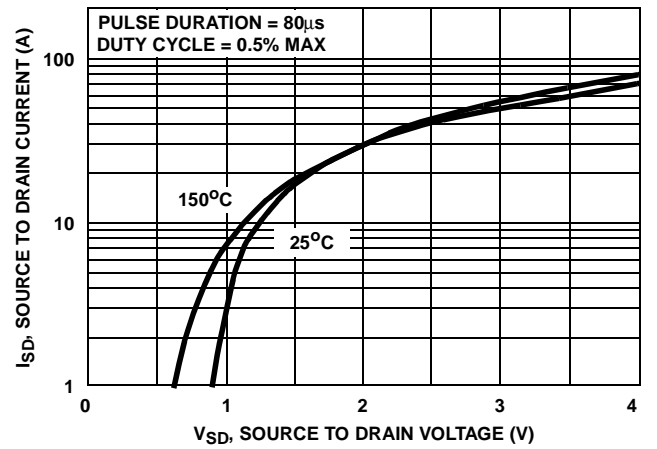

FIGURE 13. SOURCE TO DRAIN DIODE VOLTAGE

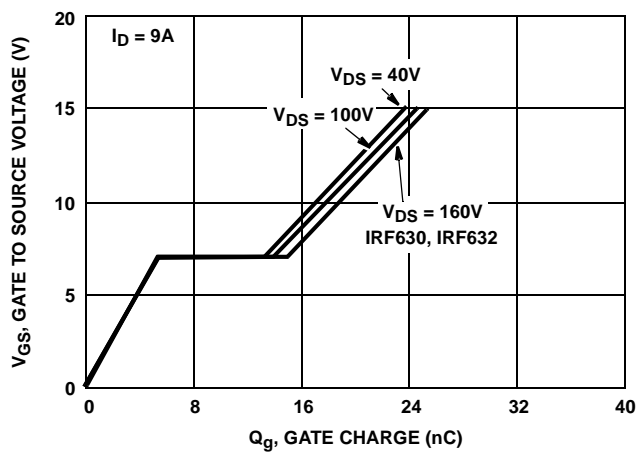

FIGURE 14. GATE TO SOURCE VOLTAGE vs GATE CHARGE

Test Circuits and Waveforms

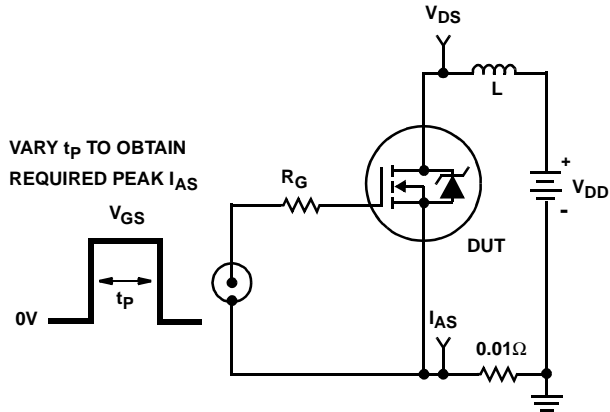

FIGURE 15. UNCLAMPED ENERGY TEST CIRCUIT

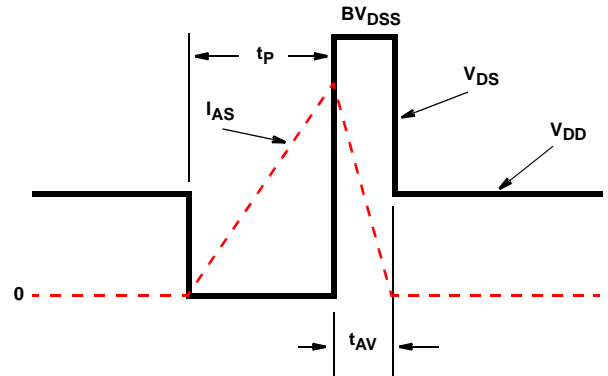

FIGURE 16. UNCLAMPED ENERGY WAVEFORMS

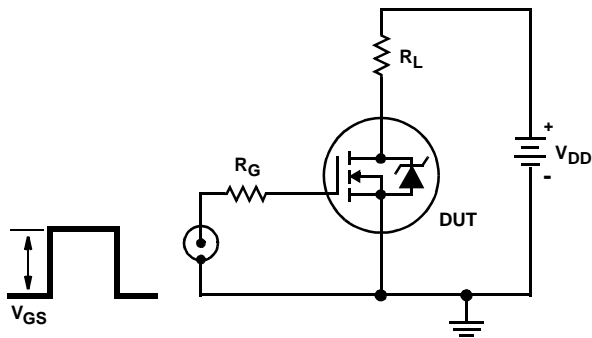

FIGURE 17. SWITCHING TIME TEST CIRCUIT

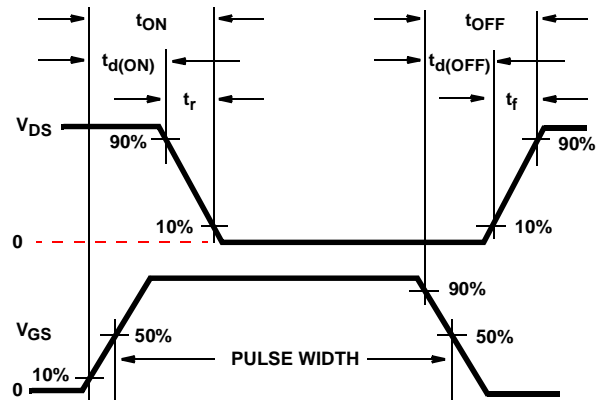

FIGURE 18. RESISTIVE SWITCHING WAVEFORMS

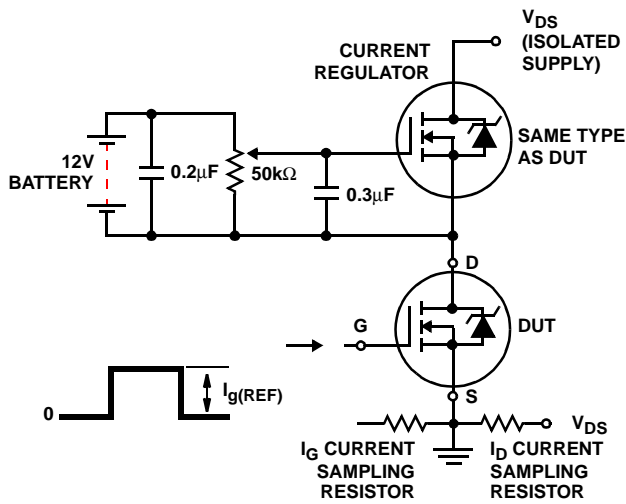

FIGURE 19. GATE CHARGE TEST CIRCUIT

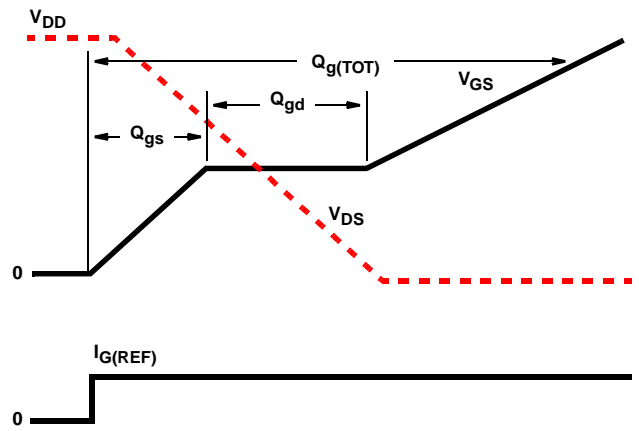

FIGURE 20. GATE CHARGE WAVEFORMS

## TRADEMARKS

The following are registered and unregistered trademarks Fairchild Semiconductor owns or is authorized to use and is not intended to be an exhaustive list of all such trademarks.

ACE <sub>x</sub> <sup>TM</sup>	FAST <sup>®</sup>	OPTOLOGIC <sup>TM</sup>	SMART START <sup>TM</sup>	VCX <sup>TM</sup>
Bottomless <sup>TM</sup>	FAST <sub>r</sub> <sup>TM</sup>	OPTOPLANAR <sup>TM</sup>	STAR*POWER <sup>TM</sup>	
CoolFET <sup>TM</sup>	FRFET <sup>TM</sup>	PACMAN <sup>TM</sup>	Stealth <sup>TM</sup>	
CROSSVOLT <sup>TM</sup>	GlobalOptoisolator <sup>TM</sup>	POP <sup>TM</sup>	SuperSOT <sup>TM</sup> -3	
DenseTrench <sup>TM</sup>	GTO <sup>TM</sup>	Power247 <sup>TM</sup>	SuperSOT <sup>TM</sup> -6	
DOMET <sup>TM</sup>	HiSeC <sup>TM</sup>	PowerTrench <sup>®</sup>	SuperSOT <sup>TM</sup> -8	
EcoSPARK <sup>TM</sup>	ISOPLANAR <sup>TM</sup>	QFET <sup>TM</sup>	SyncFET <sup>TM</sup>	
E <sup>2</sup> CMOS <sup>TM</sup>	LittleFET <sup>TM</sup>	QST <sup>TM</sup>	TinyLogic <sup>TM</sup>	
EnSigna <sup>TM</sup>	MicroFET <sup>TM</sup>	QT Optoelectronics <sup>TM</sup>	TruTranslation <sup>TM</sup>	
FACT <sup>TM</sup>	MicroPak <sup>TM</sup>	Quiet Series <sup>TM</sup>	UHC <sup>TM</sup>	
FACT Quiet Series <sup>TM</sup>	MICROWIRE <sup>TM</sup>	SILENT SWITCHER <sup>®</sup>	UltraFET <sup>®</sup>	

STAR\*POWER is used under license

## DISCLAIMER

FAIRCHILD SEMICONDUCTOR RESERVES THE RIGHT TO MAKE CHANGES WITHOUT FURTHER NOTICE TO ANY PRODUCTS HEREIN TO IMPROVE RELIABILITY, FUNCTION OR DESIGN. FAIRCHILD DOES NOT ASSUME ANY LIABILITY ARISING OUT OF THE APPLICATION OR USE OF ANY PRODUCT OR CIRCUIT DESCRIBED HEREIN; NEITHER DOES IT CONVEY ANY LICENSE UNDER ITS PATENT RIGHTS, NOR THE RIGHTS OF OTHERS.

## LIFE SUPPORT POLICY

FAIRCHILD'S PRODUCTS ARE NOT AUTHORIZED FOR USE AS CRITICAL COMPONENTS IN LIFE SUPPORT DEVICES OR SYSTEMS WITHOUT THE EXPRESS WRITTEN APPROVAL OF FAIRCHILD SEMICONDUCTOR CORPORATION.

As used herein:

1. Life support devices or systems are devices or systems which, (a) are intended for surgical implant into the body, or (b) support or sustain life, or (c) whose failure to perform when properly used in accordance with instructions for use provided in the labeling, can be reasonably expected to result in significant injury to the user.
2. A critical component is any component of a life support device or system whose failure to perform can be reasonably expected to cause the failure of the life support device or system, or to affect its safety or effectiveness.

## PRODUCT STATUS DEFINITIONS

### Definition of Terms

Datasheet Identification	Product Status	Definition
Advance Information	Formative or In Design	This datasheet contains the design specifications for product development. Specifications may change in any manner without notice.
Preliminary	First Production	This datasheet contains preliminary data, and supplementary data will be published at a later date. Fairchild Semiconductor reserves the right to make changes at any time without notice in order to improve design.
No Identification Needed	Full Production	This datasheet contains final specifications. Fairchild Semiconductor reserves the right to make changes at any time without notice in order to improve design.
Obsolete	Not In Production	This datasheet contains specifications on a product that has been discontinued by Fairchild semiconductor. The datasheet is printed for reference information only.