

HFA140MD60D

HEXFRED™

Ultrafast, Soft Recovery Diode

Features

- Reduced RFI and EMI
- Reduced Snubbing
- Extensive Characterization of Recovery Parameters

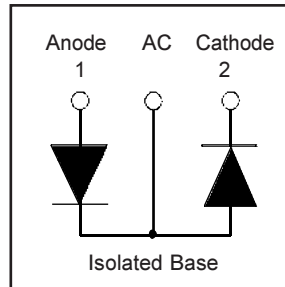

$V_R = 600V$
$V_F(\text{typ.})^{\textcircled{2}} = 1.2V$
$I_{F(AV)} = 140A$
$Q_{rr}(\text{typ.}) = 360nC$
$I_{RRM}(\text{typ.}) = 8.0A$
$t_{rr}(\text{typ.}) = 35ns$
$di_{(rec)}/dt(\text{typ.})^{\textcircled{2}} = 230A/\mu s$

Description

HEXFRED™ diodes are optimized to reduce losses and EMI/RFI in high frequency power conditioning systems. An extensive characterization of the recovery behavior for different values of current, temperature and di/dt simplifies the calculations of losses in the operating conditions. The softness of the recovery eliminates the need for a snubber in most applications. These devices are ideally suited for power converters, motors drives and other applications where switching losses are significant portion of the total losses.

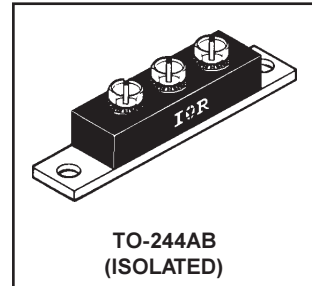

Absolute Maximum Ratings (per Leg)

	Parameter	Max.	Units
V_R	Cathode-to-Anode Voltage	600	V
$I_F @ T_C = 25^\circ C$	Continuous Forward Current	99	A
$I_F @ T_C = 100^\circ C$	Continuous Forward Current	48	
I_{FSM}	Single Pulse Forward Current ^①	600	
$P_D @ T_C = 25^\circ C$	Maximum Power Dissipation	227	W
$P_D @ T_C = 100^\circ C$	Maximum Power Dissipation	91	
T_J T_{STG}	Operating Junction and Storage Temperature Range	-55 to +150	C

Thermal - Mechanical Characteristics

	Parameter	Min.	Typ.	Max.	Units
R_{thJC}	Junction-to-Case, Single Leg Conducting	—	—	0.55	°CW K/W
	Junction-to-Case, Both Legs Conducting	—	—	0.275	
R_{thCS}	Case-to-Sink, Flat , Greased Surface	—	0.10	—	
Wt	Weight	—	79 (2.8)	—	g (oz)
	Mounting Torque ^③	30 (3.4)	—	40 (4.6)	lbf•in (N•m)
	Terminal Torque	30 (3.4)	—	40 (4.6)	
	Vertical Pull	—	—	80	lbf•in
	2 inch Lever Pull	—	—	35	

Note: ^① Limited by junction temperature
^② 125°C

^③ Mounting surface must be smooth, flat, free or burrs or other protrusions. Apply a thin even film or thermal grease to mounting surface. Gradually tighten each mounting bolt in 5-10 lbf•in steps until desired or maximum torque limits are reached. Module

HFA140MD60D

PD-40010 01/99

International
IOR Rectifier

Electrical Characteristics (per Leg) @ $T_J = 25^\circ\text{C}$ (unless otherwise specified)

	Parameter	Min.	Typ.	Max.	Units	Test Conditions
V_{BR}	Cathode Anode Breakdown Voltage	600	—	—	V	$I_R = 100\mu\text{A}$
V_{FM}	Max Forward Voltage	—	1.3	1.7	V	$I_F = 70\text{A}$ $I_F = 140\text{A}$ $I_F = 70\text{A}, T_J = 125^\circ\text{C}$ See Fig. 1
		—	1.5	2.0		
		—	1.2	1.5		
I_{RM}	Max Reverse Leakage Current	—	3.9	15	μA	$V_R = V_R$ Rated $T_J = 125^\circ\text{C}, V_R = 480\text{V}$ See Fig. 2
		—	1300	4300		
C_T	Junction Capacitance	—	200	300	pF	$V_R = 200\text{V}$ See Fig. 3
L_S	Series Inductance	—	6.0	—	nH	From top of terminal hole to mounting plane

Dynamic Recovery Characteristics (per Leg) @ $T_J = 25^\circ\text{C}$ (unless otherwise specified)

	Parameter	Min.	Typ.	Max.	Units	Test Conditions
t_{rr}	Reverse Recovery Time	—	35	—	ns	$I_F = 1.0\text{A}, di_F/dt = 200\text{A}/\mu\text{s}, V_R = 30\text{V}$ $T_J = 25^\circ\text{C}$ $T_J = 125^\circ\text{C}$ $I_F = 70\text{A}$ $V_R = 200\text{V}$ $di_F/dt = 200\text{A}/\mu\text{s}$
t_{rr1}	See Fig. 5, 10	—	90	140		
t_{rr2}		—	155	230		
I_{RRM1}	Peak Recovery Current	—	8.0	15	A	$T_J = 25^\circ\text{C}$ $T_J = 125^\circ\text{C}$ $V_R = 200\text{V}$
I_{RRM2}	See Fig. 6	—	14	25		
Q_{rr1}	Reverse Recovery Charge	—	360	1100	nC	$T_J = 25^\circ\text{C}$ $T_J = 125^\circ\text{C}$
Q_{rr2}	See Fig. 7	—	1100	2900		
$di_{(rec)M}/dt1$	Peak Rate of Fall of Recovery Current	—	300	—	A/ μs	$T_J = 25^\circ\text{C}$ $T_J = 125^\circ\text{C}$
$di_{(rec)M}/dt2$	During t_b See Fig. 8	—	230	—		

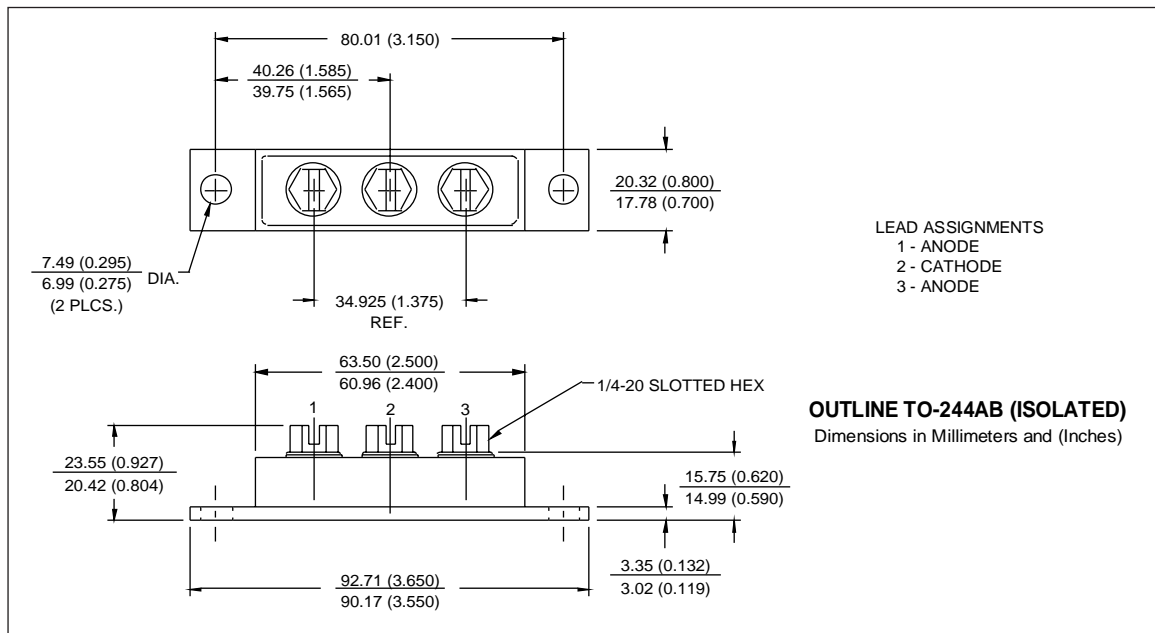

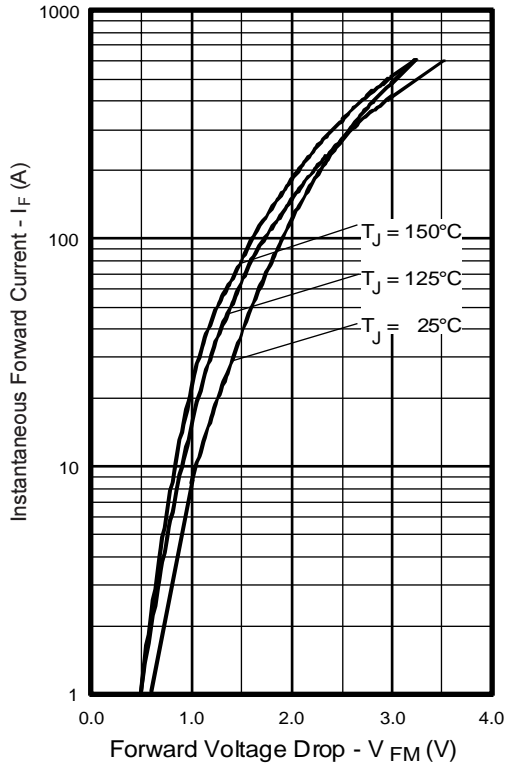

Fig. 1 - Maximum Forward Voltage Drop vs. Instantaneous Forward Current, (per Leg)

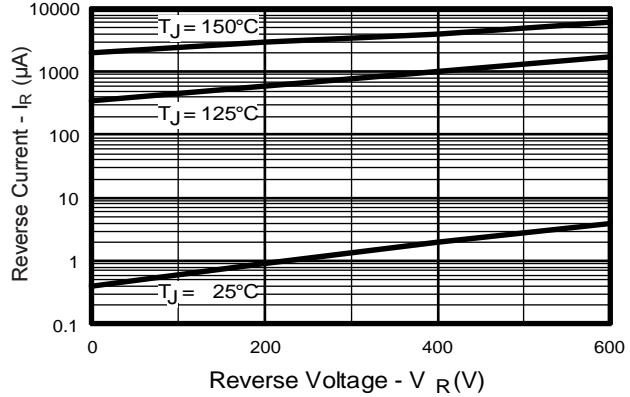

Fig. 2 - Typical Reverse Current vs. Reverse Voltage, (per Leg)

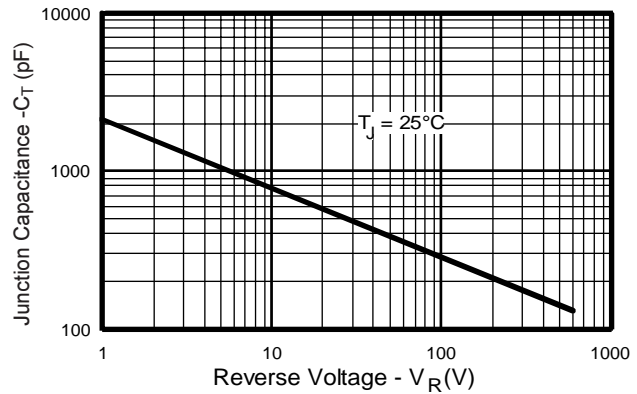

Fig. 3 - Typical Junction Capacitance vs. Reverse Voltage, (per Leg)

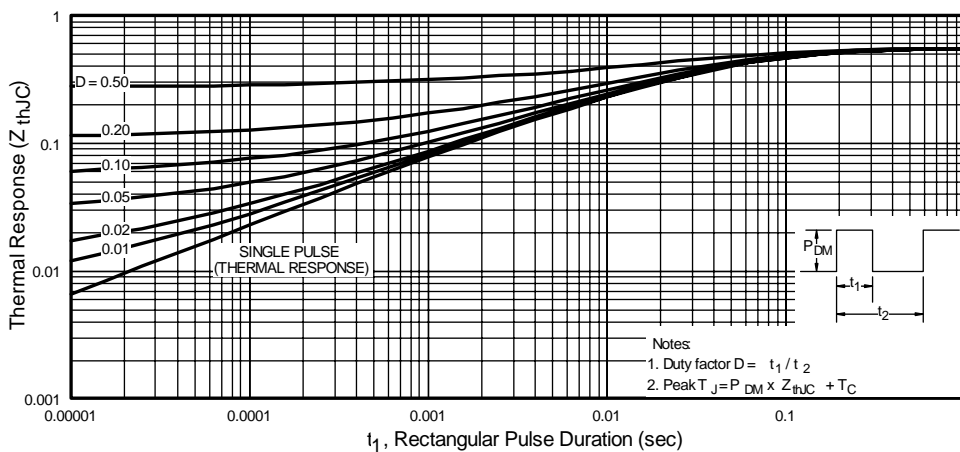

Fig. 4 - Maximum Thermal Impedance Z_{thJC} Characteristics, (per Leg)

HFA140MD60D

PD-40010 01/99

International
IOR Rectifier

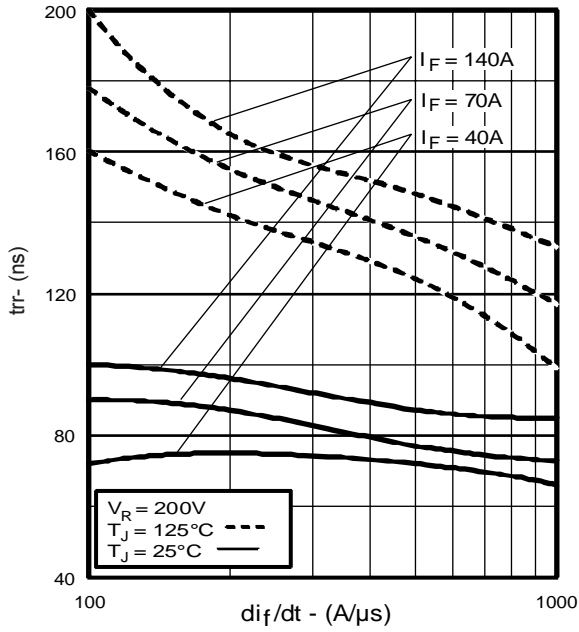

Fig. 5 - Typical Reverse Recovery Time vs. di_f/dt , (per Leg)

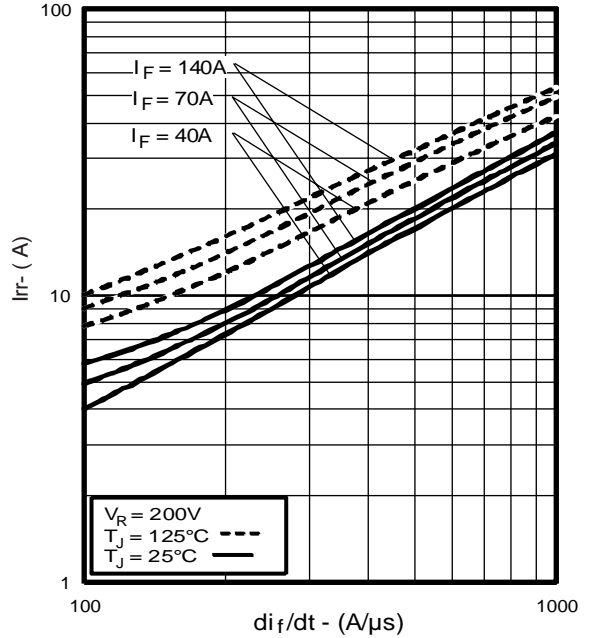

Fig. 6 - Typical Recovery Current vs. di_f/dt , (per Leg)

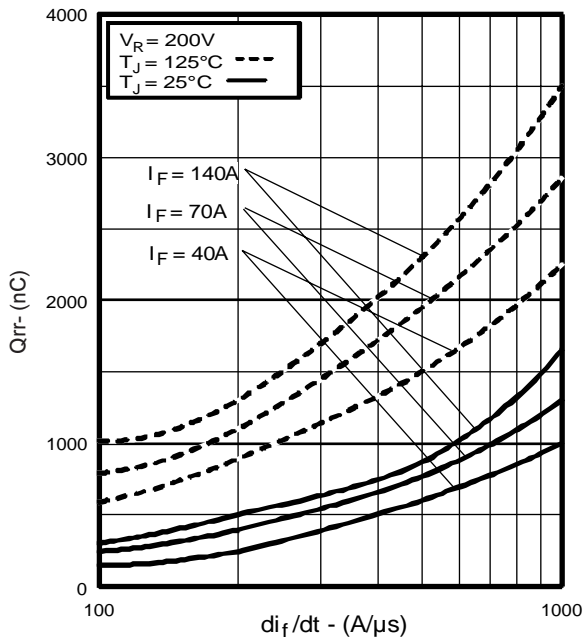

Fig. 7 - Typical Stored Charge vs. di_f/dt , (per Leg)

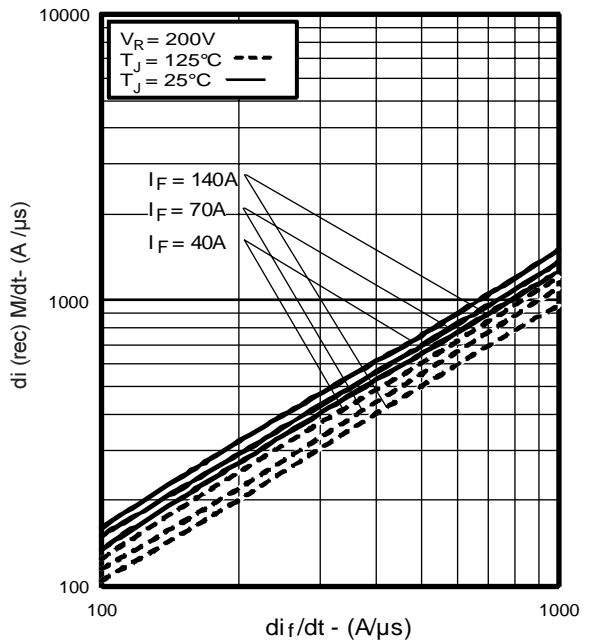

Fig. 8 - Typical $di_{(rec)}M/dt$ vs. di_f/dt , (per Leg)

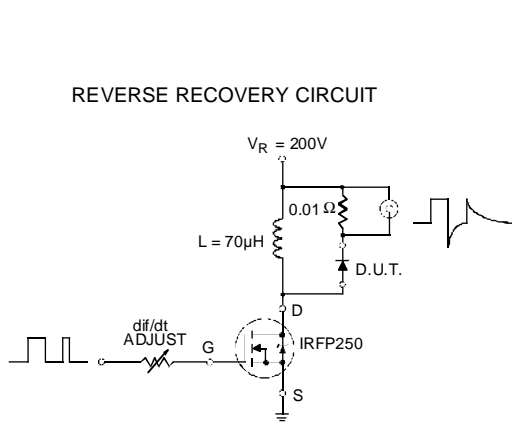
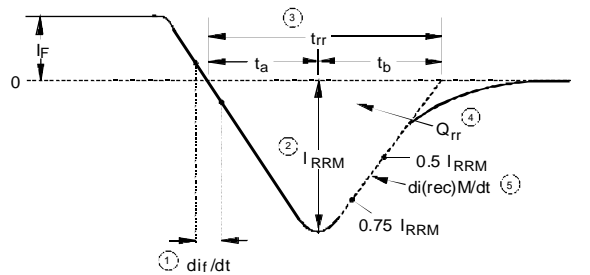

Fig. 9 - Reverse Recovery Parameter Test Circuit



1. di_r/dt - Rate of change of current through zero crossing
2. I_{RRM} - Peak reverse recovery current
3. t_{rr} - Reverse recovery time measured from zero crossing point of negative going I_F to point where a line passing through $0.75 I_{RRM}$ and $0.50 I_{RRM}$ extrapolated to zero current
4. Q_{rr} - Area under curve defined by t_{rr} and I_{RRM}
5. $di_{(rec)}/dt$ - Peak rate of change of current during t_b portion of t_{rr}

$$Q_{rr} = \frac{t_{rr} \times I_{RRM}}{2}$$

Fig. 10 - Reverse Recovery Waveform and Definitions

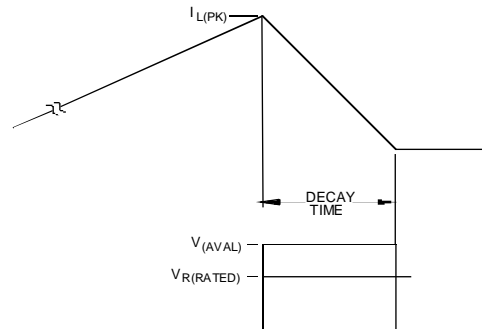
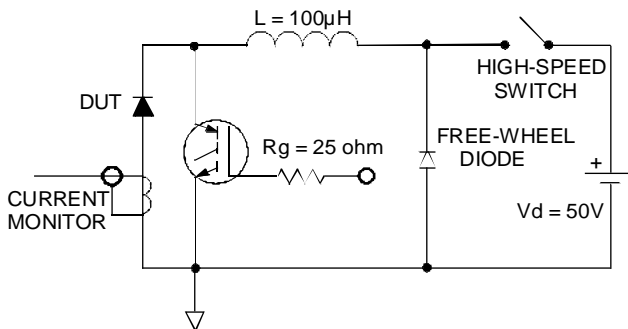

Fig. 11 - Avalanche Test Circuit and Waveforms