

**SERIES 1-HV**  
SCR Output  
Solid-State Relays

8 Thru 90 Amp  
High Voltage, AC Output

**GENERAL DESCRIPTION**

The Crydom high voltage line of solid state relays offers an extremely broad coverage of the high voltage switching market.

Long the leader in its field, the standard Crydom high voltage relays have been complemented with a series of IC driven relays that attain new levels of blocking voltage while offering the very high reliability and simplicity of IC drive circuitry.

The resulting ability to achieve standard load handling capabilities without employing a snubber allows for much lower off-state leakage and the elimination of an additional component.

The inherent zero-current turn-off characteristic of SSRs, and total absence of arcing mechanical contacts, substantially reduces electromagnetic interference and back EMF transients.

In the very high voltage line a wide range of operating voltages from 48 VAC to 660 VAC is available. In addition, blocking voltages of 1000V and 1200V peak are the norm. With current capability of 8 amperes to 90 amperes, the most difficult application problems can be overcome. Line transients caused by large equipment in electrically noisy environments are easily handled by the use of a metal oxide varistor (MOV).

The oversized output chips used, together with the Crydom optimized thermal management system, allows a narrower band of temperature excursions resulting in a significant reduction in thermal cycling fatigue, thereby extending relay life. These premium devices are recommended for use in high temperature, highly inductive load situations where the ultimate in thermal and surge performance is required.

**WIRING DIAGRAM**

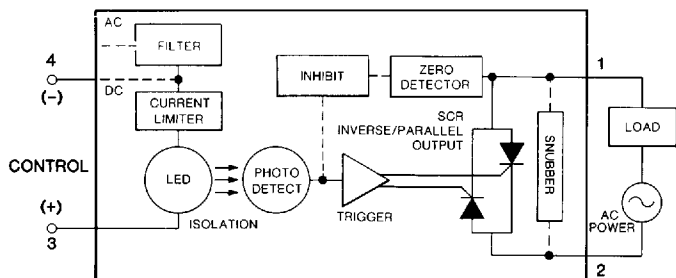

- Opto-Isolated 4000 VRMS ■
- Zero Voltage Switching (AC) ■
- 1000 & 1200V Blocking Voltage ■
- 530 & 660 Operating Voltage ■
- Superior Thermal & Surge, Ratings ■
- Wide Control Range ■
- AC & DC Input ■

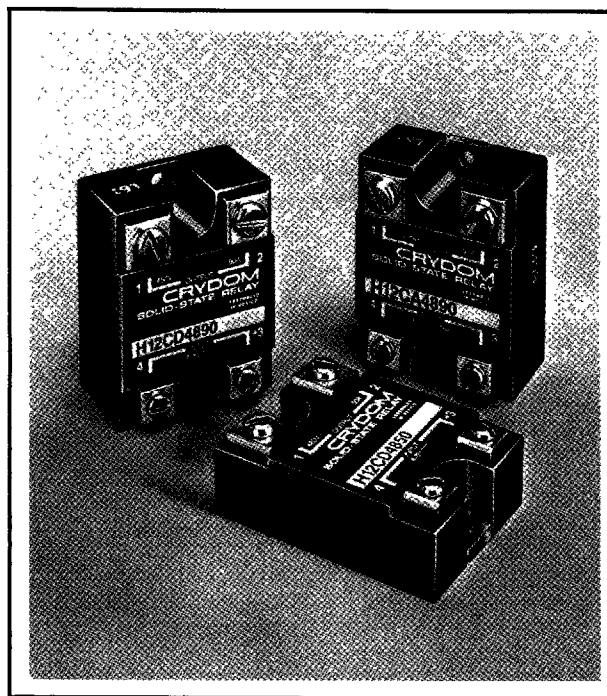

**Part Identification**

P/N Typical	Control Voltage	Continuous Volts rms	Models
H12D4850	4-32 Vdc	180-530	Standard with snubber 1 KV, 1.2 KV Blocking 50 and 90 amp
D4850C	4-32 Vdc	48-530	IC driven with snubber 1 KV Blocking 8 to 90 amp
H12CD4850	4- 8 Vdc	48-660	IC driven without snubber 1 KV, 1.2 KV Blocking 50 and 90 amp
H12WD4850	4-32 Vdc		
H12CA 4850	90-140 Vac		

# Crydom Series 1 HIGH VOLTAGE AC Power Relays

Electrical Specifications ( $0^{\circ}\text{C} \leq \text{TA} \leq 80^{\circ}\text{C}$ )

OUTPUT CHARACTERISTICS	MODEL NUMBERS				UNITS
	H10D4850	H12D4850	H10D4890	H12D4890	
Operating Voltage Range	47-63 Hz				V RMS
Max. Load Current (See derating curves)	50		90		A RMS
Min Load Current	1.0				A RMS
Transient Overvoltage (Non-repetitive)	1000	1200	1000	1200	V peak
Max. Surge Current (Non-Repetitive) 1.6 mS (See surge curves)	500		1000		A peak
Max. Over Current (Non-repetitive) 1 sec.	80		150		A RMS
Max. On-State Voltage Drop @ Rated Current	1.6				V peak
Max. I <sup>2</sup> T for Fusing (8.3 ms)	660		4150		A <sup>2</sup> sec
Thermal Resistance, Junction-to-Case, R <sub>θJC</sub> (T <sub>J</sub> Max. = 115°C)	0.63		0.31		°C/W
Power Dissipation @ Max. Current (See dissipation curves)	55		118		Watts
Max. Zero Voltage Turn-On	100				V peak
Max. Repetitive Turn-On Voltage	30				V peak
Max. Off-State Leakage Current @ Rated Voltage	12				mA RMS
Min. Off-State dv/dt (Static) @ Rated Voltage ②	200				V/μs
Power Factor Range	0.5 to 1.0				

INPUT CHARACTERISTICS		MODELS WITH H10D & H12D Prefix	UNITS
Control Voltage Range		4-32	VDC
Max. Reverse Voltage		-32	VDC
Max. Turn-On Voltage		4.0	VDC
Min. Turn-Off Voltage		1.0	VDC
Max. Input Current	5 VDC	15	mA
	32 VDC	30	
Turn-On Time (60 Hz)		8.3	mSec
Turn-Off Time (60 Hz)		8.3	mSec

GENERAL CHARACTERISTICS		ALL MODELS	UNITS
Dielectric Strength ① 50/60 Hz	Input to Output	4000	V RMS
	Input & Output to Case	4000	
Insulation Resistance @ 500 V dc		10 <sup>9</sup>	Ohms
Max. Capacitance Input/Output		16	pF
Ambient Temperature Range	Operating	-30 to 80	°C
	Storage	-40 to 125	°C

**GENERAL NOTES**

- ① Voltage applied for 1 minute.
- ② Off-state dv/dt test method per EIA/NARM standard RS-433, par. 13.11.1.
- ③ Relays will switch inductive loads from 0.5 to 1.0 power factor over temperature range.

**Mechanical Specifications**

- Weight:** 4 oz Max, 75 & 90 Amp: 5 oz Max.
- Case Material:** Fire retardant polyester
- Encapsulant:** Alumina filled epoxy
- Case Color:** Black
- Base Plate:** Aluminum, nickel plated
- Terminals:** Tin-plated Brass, Nickel-plated screws & saddle clamps supplied unmounted

**Dimensional Drawing**

**Tolerances:** ± 0.02 (0.50) (unless otherwise noted)  
**Dimensions:** Inches (mm)

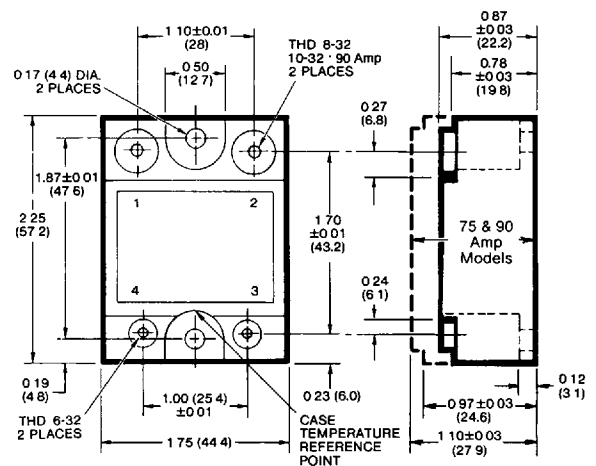

IC Driven High Voltage Models.

OUTPUT CHARACTERISTICS		IC DRIVEN HIGH VOLTAGE WITH OUTPUT SNUBBER ("C" Suffix)								IC DRIVEN VERY HIGH VOLTAGE WITHOUT SNUBBER								UNITS
MODEL NUMBERS	DC CONTROL	D4808C	D4812C	D4825C	D4850C	D4875C	D4890C	H10 CD4850	H10 CD4890	H12 CD4850	H12 CD4890	H10 WD4850	H10 WD4890	H12 WD4850	H12 WD4890	V		
	AC CONTROL	8	12	25	50	75	90	50	90	50	90	50	90	50	90			
Operating Voltage Range 47-63 Hz																		
Max. Load Current (see Derating Curves)																		
Min. Load Current																		
Transient Overvoltage																		
Max. Surge Current (Non-Repetitive) 16.6 ms (See Surge Curves)																		
Max. Over Current (Non-Repetitive) 1 sec.																		
Max. On-State Voltage Drop @ Rated Current																		
Max. I <sup>2</sup> t for Fusing (8.3 ms)																		
Thermal Resistance, Junction to Case, R <sub>θJC</sub> (T <sub>J</sub> Max = 115°C)																		
Power Dissipation @ Max. Current (See Dissipation Curves)																		
Max. Zero Voltage Turn-On																		
Max. Peak Repetitive Turn-On Voltage																		
Max. Off-State Leakage Current @ Rated Operating Volt (-30°C ≤ T <sub>A</sub> ≤ 80°C)																		
Min. Off-State dv/dt (Static) @ Max. Rated Voltage																		
Power Factor Range																		

INPUT CHARACTERISTICS	DC INPUT MODELS WITH "C" Suffix, H10WD & H12WD Prefix		DC INPUT MODELS WITH H10CD & H12CD Prefix		DC INPUT MODELS WITH H10CA & H12CA Prefix	
	4-32 VDC	32 VDC	4 VDC	1 VDC	4-8 VDC	8 VDC
Control Voltage Range	4-32 VDC	32 VDC	4 VDC	1 VDC	4-8 VDC	8 VDC
Max. Reverse Voltage	32 VDC	4 VDC	1 VDC	250 Ohms	8 VDC	90 V(RMS)
Max. Turn-On Voltage (-30°C ≤ T <sub>A</sub> ≤ 80°C)	4 VDC	1 VDC	250 Ohms	10 K Ohms	90 V(RMS)	90 V(RMS)
Min. Turn-Off Voltage (-30°C ≤ T <sub>A</sub> ≤ 80°C)	1000 Ohms @ 32 VDC	15mA (@ 5 VDC)	18mA (@ 5 VDC)	10 V(RMS)	10 V(RMS)	10 V(RMS)
Min. Input Impedance	15mA (@ 5 VDC)	8.3ms	8.3ms	15mA (@ 140 VAC)	15mA (@ 140 VAC)	15mA (@ 140 VAC)
Max. Input Current	8.3ms	8.3ms	8.3ms	25ms	25ms	25ms
Max. Turn-On Time (60 Hz)	8.3ms	8.3ms	8.3ms	50ms	50ms	50ms
Max. Turn-Off Time (60 Hz)	8.3ms	8.3ms	8.3ms	50ms	50ms	50ms

Data and specifications subject to change without notice.

# Thermal Characteristics

## THERMAL CHARACTERISTICS

A major consideration in the use of solid-state relays is the thermal design. It is essential that the user provide adequate heat sinking for the application.

The simplified thermal model (Figure 1) indicates the basic elements to be considered in the thermal design. The values to be chosen or determined by the user are the case-to-heatsink interface thermal resistance ( $R_{\theta CS}$ ) and the heatsink-to-ambient thermal resistance ( $R_{\theta SA}$ ).

Referring to Figures 4, 5, 6 & 11 the left halves show power dissipation versus load current. The right halves are families of curves which are used in selecting the required heatsink to maintain a maximum case temperature for a given ambient. It is important to note that the thermal resistance values ( $^{\circ}\text{C}/\text{W}$ ) shown include both case-to-heatsink interface ( $R_{\theta CS}$ ) as well as the heatsink-to-ambient thermal resistance ( $R_{\theta CA}$ ). Thus, when selecting a heatsink, the value of ( $R_{\theta CS}$ ) must be subtracted from the number indicated by the curve in order to determine the ( $R_{\theta CA}$ ).

As a point of information, if the SSR is firmly mounted on a smooth heatsink surface using thermally conductive grease, the value of  $R_{\theta CS}$  (case-to-heatsink interface) will typically be  $0.1^{\circ}\text{C}/\text{W}$  or less. Examples of how the curves are used are explained in conjunction with (Figure 5).

### EXAMPLE 1

If a D4825C is mounted on a heatsink with a thermal resistance of  $1^{\circ}\text{C}/\text{W}$  (including the  $R_{\theta CS}$ ) and must operate in an ambient of  $60^{\circ}\text{C}$ , the allowable current of 23A may be determined by following the route A,B,C,D (Figure 5). Additional information on power dissipation and maximum allowable case temperature can be found by extending line C,B to points E and F where the values of 26W and  $89^{\circ}\text{C}$  are read.

### EXAMPLE 2

If a current of 16A is required for a D4825C in an ambient of  $55^{\circ}\text{C}$ , the necessary heatsink, plus interface, thermal resistance of  $2.7^{\circ}\text{C}/\text{W}$  may be determined by following the route I,J,K,L (Figure 5). Additional information on power dissipation and case temperature can be determined from the route I,J to the power dissipation curve, then run line M,N parallel to the x axis through point J. By then following the route K,L the required thermal impedance of the heatsink can be determined. M and N are now the points where the values of 16W and  $99^{\circ}\text{C}$  are read.

This information can be used in heatsink selection from manufacturer's dissipation versus thermal resistance curves such as those shown in Figure 2 and 3. The thermal resistance of curve (a) at 16 watts is  $2.5^{\circ}\text{C}/\text{W}$ . This is better than the required  $2.7^{\circ}\text{C}/\text{W}$  in example 2, allowing  $0.2^{\circ}\text{C}/\text{W}$  for  $R_{\theta CS}$ , and is therefore suitable for this application.

Alternatively, heatsink (b) at 16 watts is  $1.9^{\circ}\text{C}/\text{W}$ . Adding  $0.1^{\circ}\text{C}/\text{W}$  for  $R_{\theta CS}$  and returning to Figure 5, it would allow operation at a maximum ambient of  $65^{\circ}\text{C}$  instead of  $55^{\circ}\text{C}$ .

Confirmation of proper heatsink selection can be achieved by actual temperature measurement under worse case conditions. The measurement can be taken on the metal baseplate in the area of the mounting screw, and should not exceed the maximum allowable case temperature shown in the graphs.

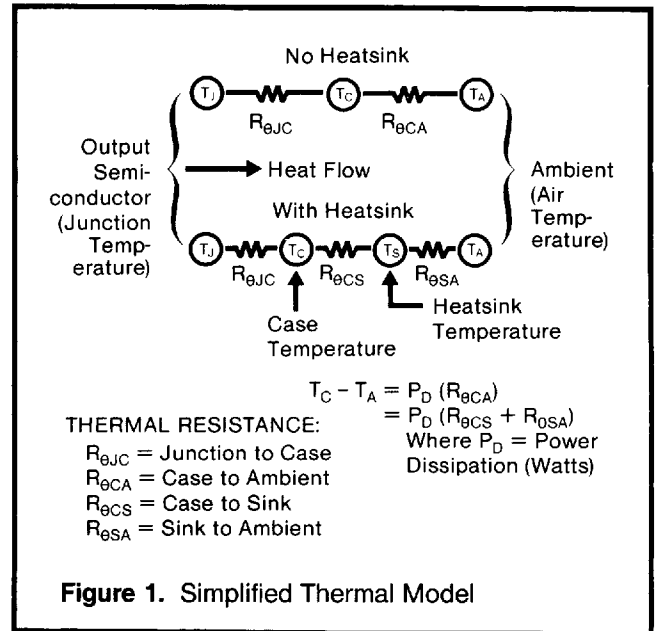

Figure 1. Simplified Thermal Model

## TYPICAL HEAT SINK CHARACTERISTICS

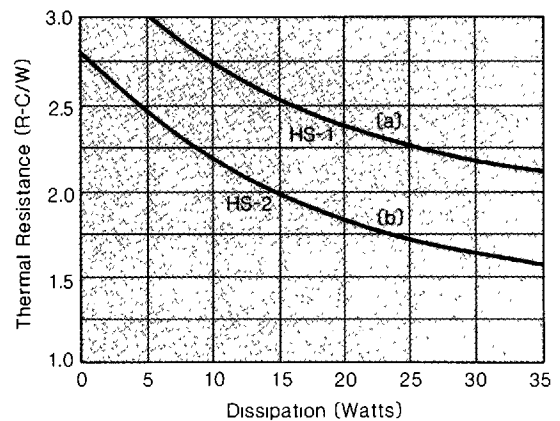

Figure 2. Thermal Resistance Models HS-1 & HS-2

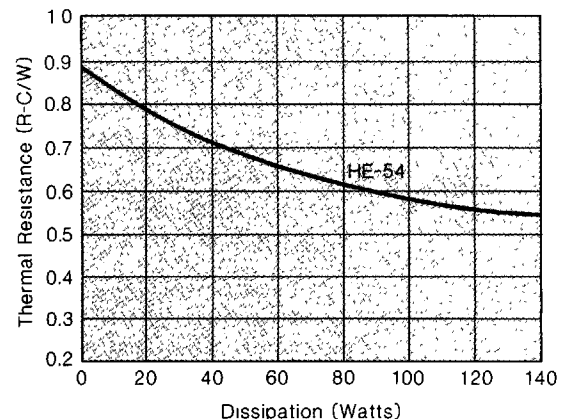

Figure 3. Thermal Resistance Model HE-54

# Thermal Characteristics

# Surge Characteristics

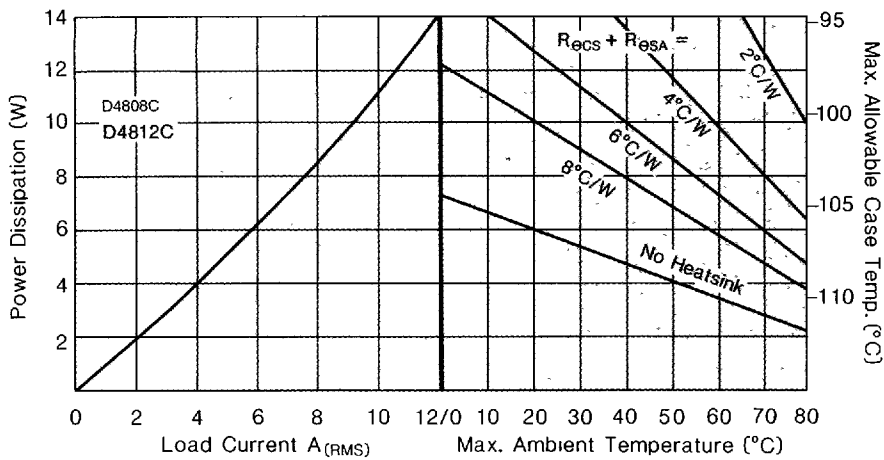

Figure 4. Thermal Derating Curves: 8 & 12 Amp., 480V

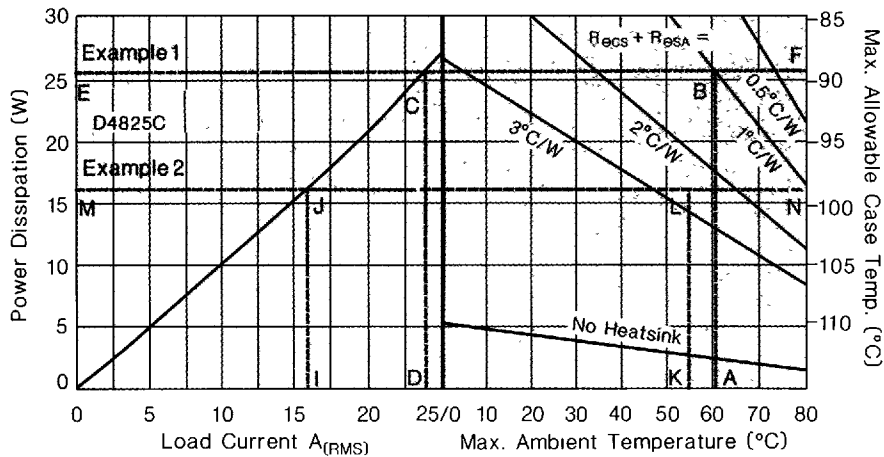

Figure 5. Thermal Derating Curves: 25 Amp., 480V

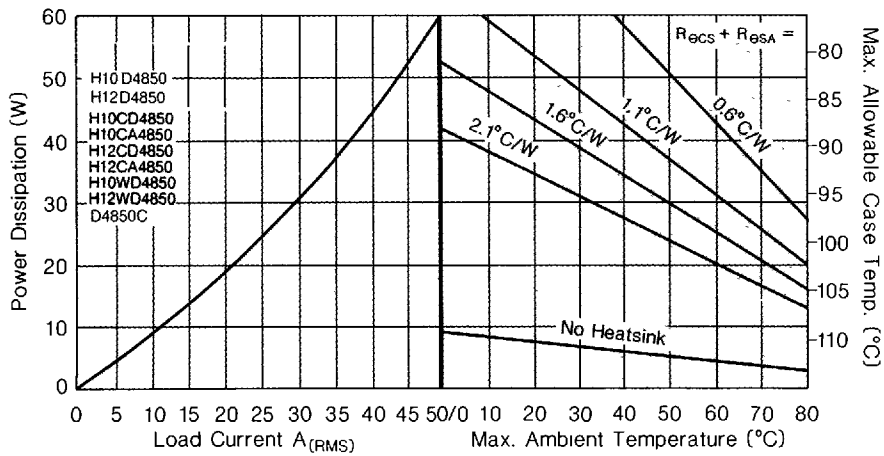

Figure 6. Thermal Derating Curves: 50 Amp., 480V

The curves in figures 7, 8, 9 and 10 apply to a non-repetitive uniform amplitude surge of a given time and peak current, preceded and followed by any rated load condition. Also shown is the number of these surge occurrences that can be tolerated before device damage. For example, for a D4812, a life of  $10^8$  surge occurrences can be estimated for a 24 Amp peak surge (200% of steady-state), of 0.6 seconds duration (Figure 8). The junction temperature must be allowed to return to its steady-state value before reapplication of surge current. Control of conduction may be momentarily lost if currents exceed  $10^4$  curve values from initial junction temperatures greater than  $40^\circ\text{C}$ .

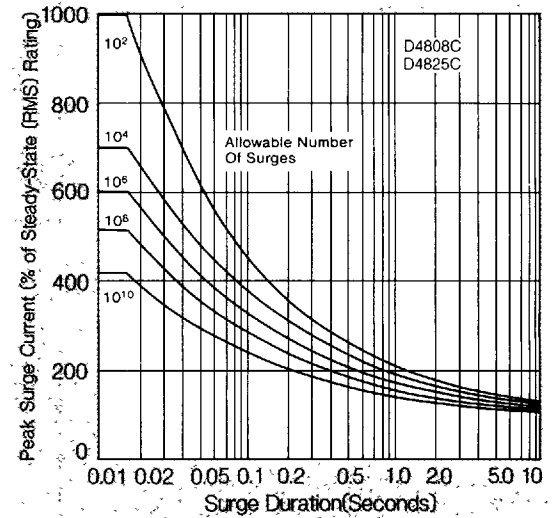

Figure 7. Peak Surge Current vs. Duration: 8 and 25 Amp Models.

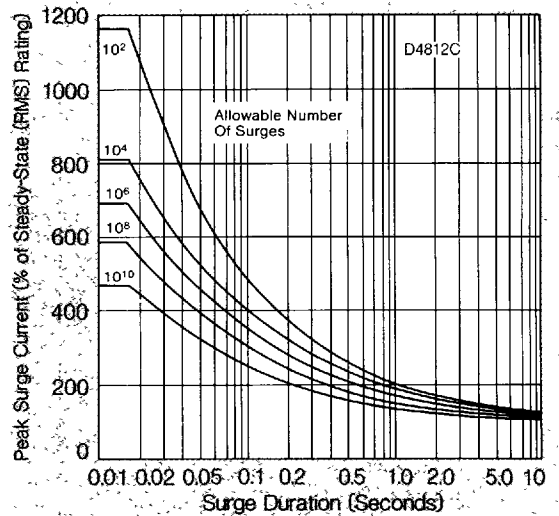
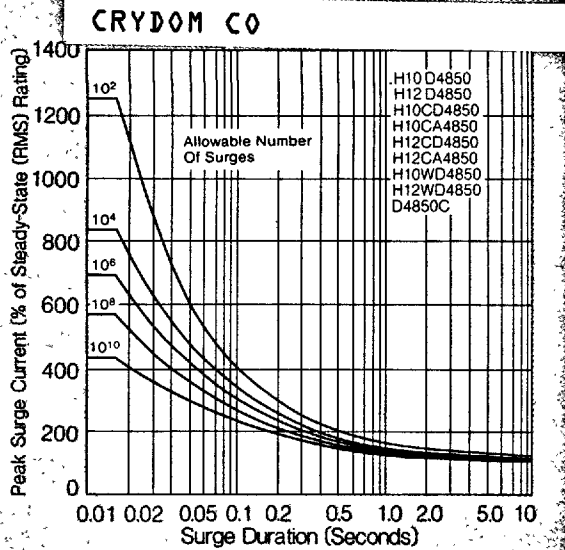
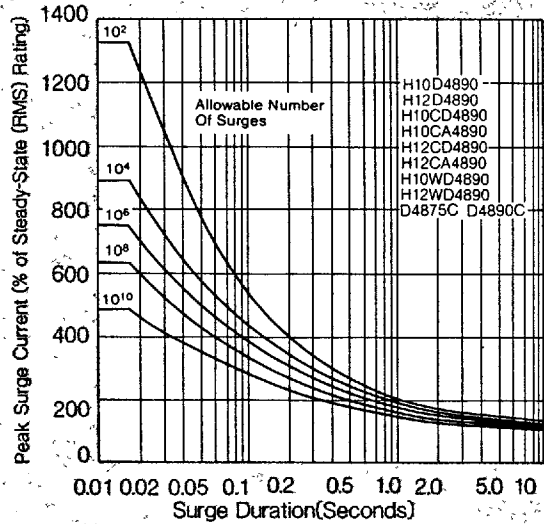

Figure 8. Peak Surge Current vs. Duration: 12 Amp Models.

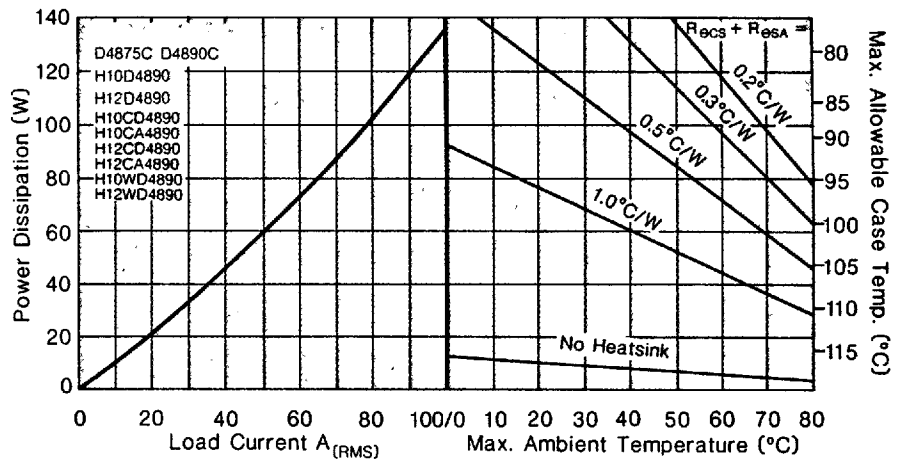

**Figure 9. Peak Surge Current vs. Duration: 50 Amp Models.**



**Figure 10. Peak Surge Current vs. Duration: 75 and 90 Amp Models.**

31E D ■ 2542537 0000645 6 ■ CRY T-25-31



**Figure 11. Thermal Derating Curves: 75 & 90 Amp., 480V**

**CRYDOM**  
COMPANY

**CRYDOM**  
WORLD HEADQUARTERS

P.O. Box 3699  
Lakewood, CA 90711-3699  
TELEPHONE: (213) 865-3536  
FAX: (213) 865-3318 TELEX: 910 250-5756

**U.S.A.**  
Crydom Company  
17215 Studebaker Road  
Cerritos, CA 90701  
Phone: (213) 865-3536  
FAX: (213) 865-3318  
Telex: 910 250 5756

**CANADA**  
International Rectifier  
101 Bentley Street  
Markham, Ontario L3R 311  
Phone: (416) 475-1897  
FAX: (416) 475-8801  
Telex: 06 966 650

**WEST GERMANY**  
Crydom GMBH  
Quellenweg 9  
D6935 Waldbrunn 2  
Phone: 6274 6437  
FAX: 6274 1472  
Telex: 17627492

**ENGLAND**  
Crydom UK  
42 Station Road East  
Oxted Surrey RH 8 OPG  
Phone: 0883 717250  
FAX: 0883 717253  
Telex: 957 440

Sales Offices, Agents and Distributors in Major Cities throughout the World.