



vorläufige Daten  
 preliminary data

### Höchstzulässige Werte / maximum rated values

#### Elektrische Eigenschaften / electrical properties

Kollektor Emitter Sperrspannung collector emitter voltage	$T_{vj} = 25^{\circ}\text{C}$	$V_{CES}$	1200	V
Kollektor Dauergleichstrom DC collector current	$T_c = 80^{\circ}\text{C}$ $T_c = 25^{\circ}\text{C}$	$I_{C, nom}$ $I_C$	600 850	A A
Periodischer Kollektor Spitzenstrom repetitive peak collector current	$t_p = 1\text{ms}, T_c = 80^{\circ}\text{C}$	$I_{CRM}$	1200	A
Gesamt Verlustleistung total power dissipation	$T_c = 25^{\circ}\text{C};$ Transistor	$P_{tot}$	2,8	kW
Gate Emitter Spitzenspannung gate emitter peak voltage		$V_{GES}$	+/- 20	V
Dauergleichstrom DC forward current		$I_F$	600	A
Periodischer Spitzenstrom repetitive peak forward current	$t_p = 1\text{ms}$	$I_{FRM}$	1200	A
Grenzlastintegral $I^2t$ value	$V_R = 0\text{V}, t_p = 10\text{ms}, T_{vj} = 125^{\circ}\text{C}$	$I^2t$	75	k A <sup>2</sup> s
Isolations Prüfspannung insulation test voltage	RMS, f= 50Hz, t= 1min.	$V_{ISOL}$	2,5	kV

### Charakteristische Werte / characteristic values

#### Transistor Wechselrichter / transistor inverter

			min.	typ.	max.	
Kollektor Emitter Sättigungsspannung collector emitter saturation voltage	$I_C = 600\text{A}, V_{GE} = 15\text{V}, T_{vj} = 25^{\circ}\text{C},$ $I_C = 600\text{A}, V_{GE} = 15\text{V}, T_{vj} = 125^{\circ}\text{C},$	$V_{CEsat}$	-	1,7	2,15	V
Gate Schwellenspannung gate threshold voltage	$I_C = 24\text{mA}, V_{CE} = V_{GE}, T_{vj} = 25^{\circ}\text{C},$	$V_{GE(th)}$	5	5,8	6,5	V
Gateladung gate charge	$V_{GE} = -15\text{V} \dots +15\text{V}; V_{CE} = \dots\text{V}$	$Q_G$	-	5,8	-	$\mu\text{C}$
Eingangskapazität input capacitance	f= 1MHz, $T_{vj} = 25^{\circ}\text{C}, V_{CE} = 25\text{V}, V_{GE} = 0\text{V}$	$C_{ies}$	-	43	-	nF
Rückwirkungskapazität reverse transfer capacitance	f= 1MHz, $T_{vj} = 25^{\circ}\text{C}, V_{CE} = 25\text{V}, V_{GE} = 0\text{V}$	$C_{res}$	-	2	-	nF
Kollektor Emitter Reststrom collector emitter cut off current	$V_{GE} = 0\text{V}, T_{vj} = 25^{\circ}\text{C}, V_{CE} = 1200\text{V}$	$I_{CES}$	-	-	5	mA
Gate Emitter Reststrom gate emitter leakage current	$V_{CE} = 0\text{V}, V_{GE} = 20\text{V}, T_{vj} = 25^{\circ}\text{C}$	$I_{GES}$	-	-	400	nA

prepared by: MOD-D2; Mark Münzer

date of publication: 2002-07-30

approved: SM TM; Christoph Lübke

revision: 2.0



**vorläufige Daten**  
**preliminary data**

### Charakteristische Werte / characteristic values

#### Transistor Wechselrichter / transistor inverter

			min.	typ.	max.	
Einschaltverzögerungszeit (ind. Last) turn on delay time (inductive load)	$I_C = 600A, V_{CC} = 600V$ $V_{GE} = \pm 15V, R_{Gon} = 3,6\Omega, T_{vj} = 25^\circ C$	$t_{d,on}$	-	0,60	-	$\mu s$
	$V_{GE} = \pm 15V, R_{Gon} = 3,6\Omega, T_{vj} = 125^\circ C$		-	0,66	-	$\mu s$
Anstiegszeit (induktive Last) rise time (inductive load)	$I_C = 600A, V_{CC} = 600V$ $V_{GE} = \pm 15V, R_{Gon} = 3,6\Omega, T_{vj} = 25^\circ C$	$t_r$	-	0,23	-	$\mu s$
	$V_{GE} = \pm 15V, R_{Gon} = 3,6\Omega, T_{vj} = 125^\circ C$		-	0,22	-	$\mu s$
Abschaltverzögerungszeit (ind. Last) turn off delay time (inductive load)	$I_C = 600A, V_{CC} = 600V$ $V_{GE} = \pm 15V, R_{Goff} = 1,2\Omega, T_{vj} = 25^\circ C$	$t_{d,off}$	-	0,82	-	$\mu s$
	$V_{GE} = \pm 15V, R_{Goff} = 1,2\Omega, T_{vj} = 125^\circ C$		-	0,96	-	$\mu s$
Fallzeit (induktive Last) fall time (inductive load)	$I_C = 600A, V_{CC} = 600V$ $V_{GE} = \pm 15V, R_{Goff} = 1,2\Omega, T_{vj} = 25^\circ C$	$t_f$	-	0,15	-	$\mu s$
	$V_{GE} = \pm 15V, R_{Goff} = 1,2\Omega, T_{vj} = 125^\circ C$		-	0,18	-	$\mu s$
Einschaltverlustenergie pro Puls turn on energy loss per pulse	$I_C = 600A, V_{CC} = 600V, L_\sigma = 120nH$ $V_{GE} = \pm 15V, R_{Gon} = 3,6\Omega, T_{vj} = 125^\circ C$	$E_{on}$	-	120	-	mJ
Ausschaltverlustenergie pro Puls turn off energy loss per pulse	$I_C = 600A, V_{CC} = 600V, L_\sigma = 120nH$ $V_{GE} = \pm 15V, R_{Goff} = 1,2\Omega, T_{vj} = 125^\circ C$	$E_{off}$	-	95	-	mJ
Kurzschlussverhalten SC data	$t_p \leq 10\mu s, V_{GE} \leq 15V, T_{vj} \leq 125^\circ C$ $V_{CC} = 900V, V_{CEmax} = V_{CES} - L_{\sigma CE} \cdot  di/dt $	$I_{SC}$	-	2400	-	A
Modulinduktivität stray inductance module		$L_{\sigma CE}$	-	20	-	nH
Leitungswiderstand, Anschluss-Chip lead resistance, terminal-chip	$T_c = 25^\circ C$	$R_{CC/EE}$	-	0,18	-	m $\Omega$

### Charakteristische Werte / characteristic values

#### Diode Wechselrichter / diode inverter

Durchlassspannung forward voltage	$I_F = I_{C, nom}, V_{GE} = 0V, T_{vj} = 25^\circ C$	$V_F$	-	2,0	2,5	V
	$I_F = I_{C, nom}, V_{GE} = 0V, T_{vj} = 125^\circ C$		-	1,8	-	V
Rückstromspitze peak reverse recovery current	$I_F = I_{C, nom}, -di_f/dt = 2400A/\mu s$ $V_R = 600V, V_{GE} = -15V, T_{vj} = 25^\circ C$	$I_{RM}$	-	170	-	A
	$V_R = 600V, V_{GE} = -15V, T_{vj} = 125^\circ C$		-	265	-	A
Sperrverzögerungsladung recovered charge	$I_F = I_{C, nom}, -di_f/dt = 2400A/\mu s$ $V_R = 600V, V_{GE} = -15V, T_{vj} = 25^\circ C$	$Q_r$	-	25	-	$\mu C$
	$V_R = 600V, V_{GE} = -15V, T_{vj} = 125^\circ C$		-	60	-	$\mu C$
Ausschaltenergie pro Puls reverse recovery energy	$I_F = I_{C, nom}, -di_f/dt = 2400A/\mu s$ $V_R = 600V, V_{GE} = -15V, T_{vj} = 25^\circ C$	$E_{rec}$	-	6	-	mJ
	$V_R = 600V, V_{GE} = -15V, T_{vj} = 125^\circ C$		-	17	-	mJ

# Technische Information / technical information

eupec

IGBT-Module  
IGBT-Modules

FF600R12KE3



**vorläufige Daten**  
**preliminary data**

## Thermische Eigenschaften / thermal properties

			min.	typ.	max.	
Innerer Wärmewiderstand thermal resistance, junction to case	Transistor, DC, pro Modul / per module	$R_{thJC}$	-	-	0,022	K/W
	Transistor, DC, pro Zweig / per arm		-	-	0,044	K/W
	Diode/Diode, DC, pro Modul / per module		-	-	0,040	K/W
	Diode/Diode, DC, pro Zweig / per arm		-	-	0,080	K/W
Übergangs Wärmewiderstand thermal resistance, case to heatsink	pro Modul / per module	$R_{thCK}$	-	0,006	-	K/W
	pro Zweig/ per arm $\lambda_{\text{Paste}}/\lambda_{\text{grease}} = 1\text{W/m}^2\text{K}$		-	0,012	-	K/W
Höchstzulässige Sperrschichttemp. maximum junction temperature		$T_{vj\max}$	-	-	150	°C
Betriebstemperatur operation temperature		$T_{vj\text{op}}$	-40	-	125	°C
Lagertemperatur storage temperature		$T_{stg}$	-40	-	125	°C

## Mechanische Eigenschaften / mechanical properties

Gehäuse, siehe Anlage case, see appendix						
Innere Isolation internal insulation				$\text{Al}_2\text{O}_3$		
Kriechstrecke creepage distance				17		mm
Luftstrecke clearance				10		mm
CTI comperative tracking index				>400		
Anzugsdrehmoment, mech. Befestigung mounting torque	Schraube / screw M5	M	4,25	-	5,75	Nm
Anzugsdrehmoment, elektr. Anschlüsse terminal connection torque	Anschlüsse / terminal M4	M	1,7	-	2,3	Nm
	Anschlüsse / terminal M8	M	8	-	10	Nm
Gewicht weight		G		1500		g

Mit dieser technischen Information werden Halbleiterbauelemente spezifiziert, jedoch keine Eigenschaften zugesichert. Sie gilt in Verbindung mit den zugehörigen technischen Erläuterungen.

This technical information specifies semiconductor devices but promises no characteristics. It is valid with the belonging technical notes.



vorläufige Daten  
preliminary data

**Ausgangskennlinie (typisch)**  
**output characteristic (typical)**

$I_C = f(V_{CE})$   
 $V_{GE} = 15V$

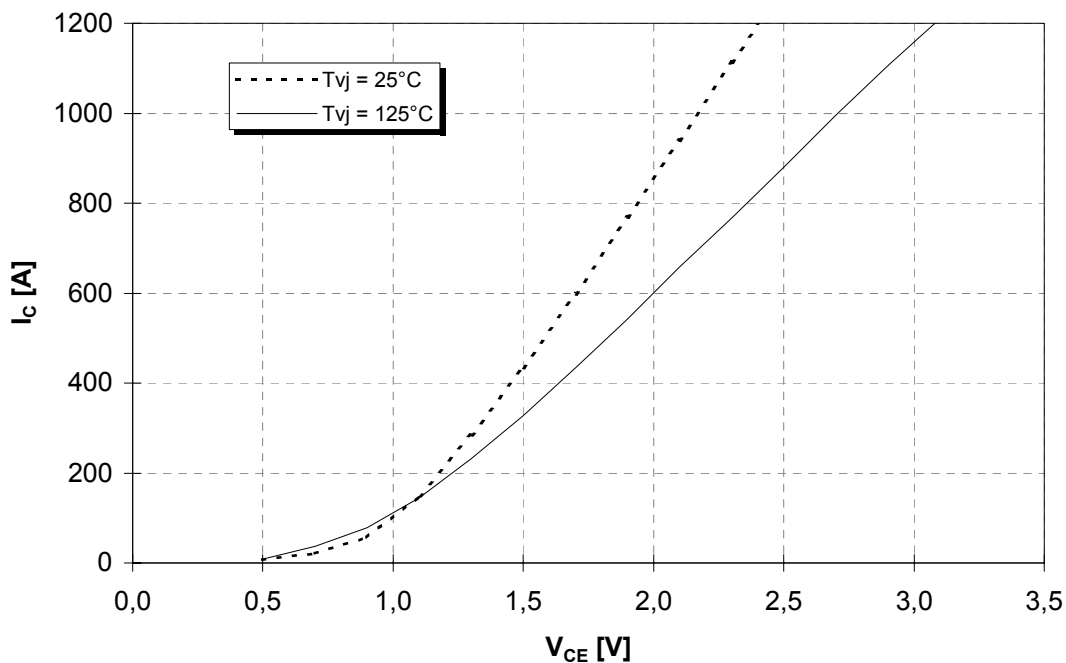

**Ausgangskennlinienfeld (typisch)**  
**output characteristic (typical)**

$I_C = f(V_{CE})$   
 $T_{vj} = 125^\circ C$

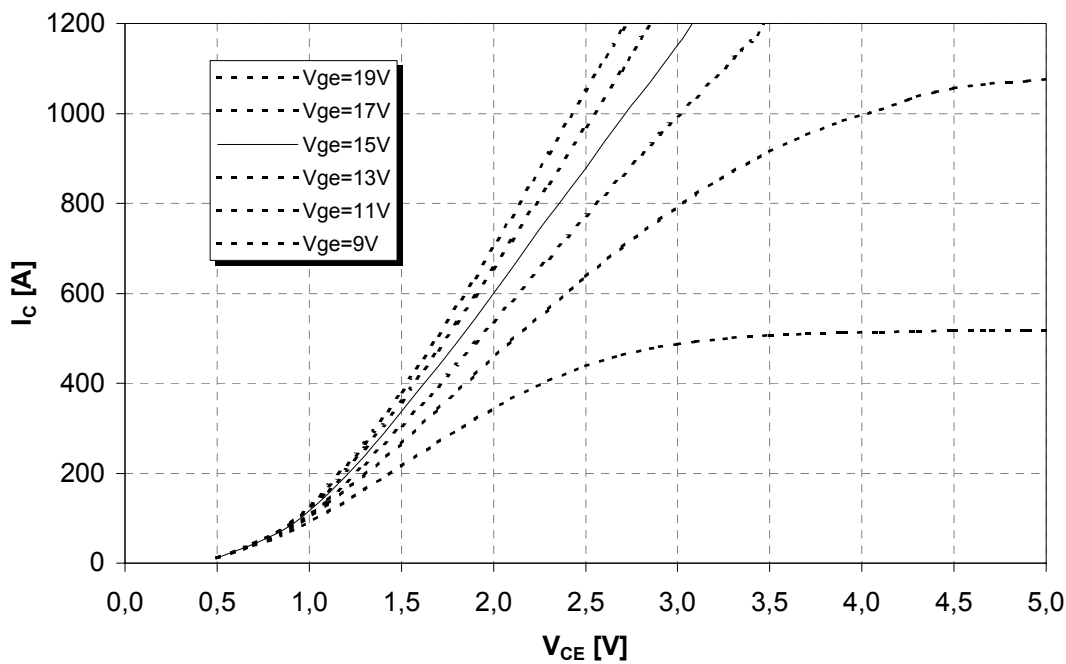



vorläufige Daten  
preliminary data

Übertragungscharakteristik (typisch)  
transfer characteristic (typical)

$I_C = f(V_{GE})$   
 $V_{CE} = 20V$

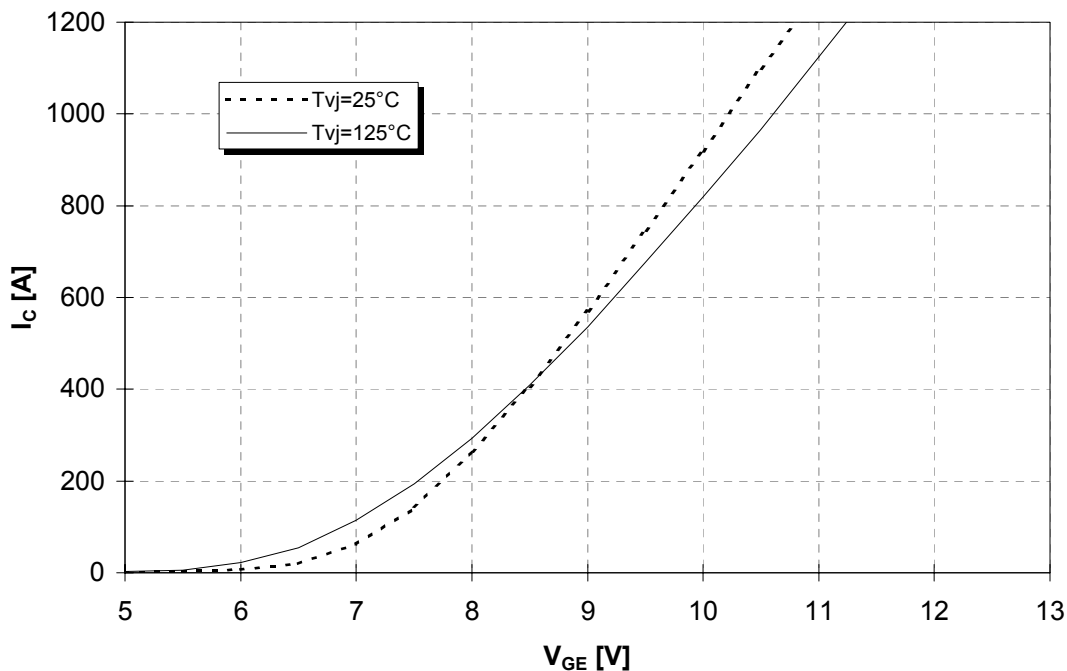

Durchlasskennlinie der Inversdiode (typisch)  
forward characteristic of inverse diode (typical)

$I_F = f(V_F)$

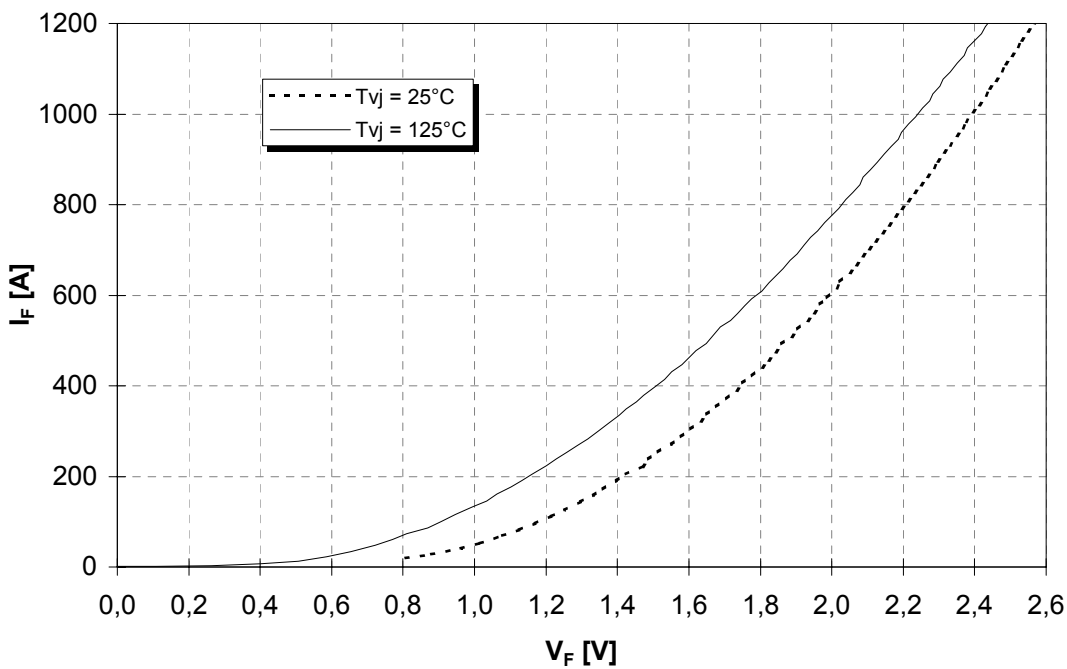



vorläufige Daten  
preliminary data

**Schaltverluste (typisch)**  
**Switching losses (typical)**

$$E_{on} = f(I_C), E_{off} = f(I_C), E_{rec} = f(I_C)$$

$V_{GE} = \pm 15V, R_{\theta on} = 3,6\Omega, R_{\theta off} = 1,2\Omega, V_{CE} = 600V, T_{vi} = 125^\circ C$

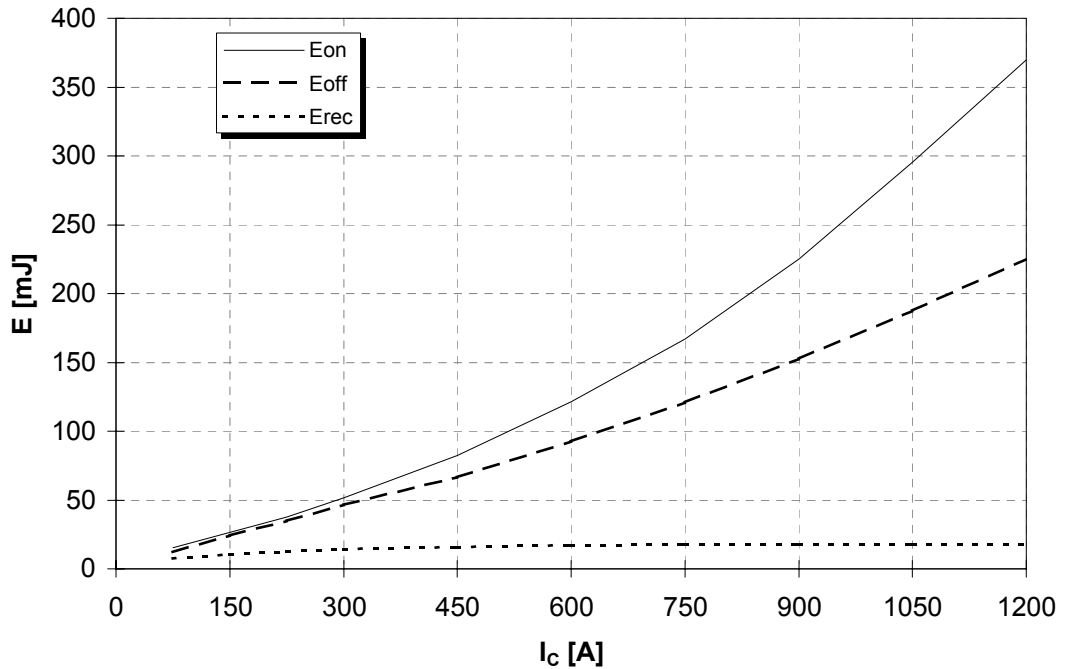

**Schaltverluste (typisch)**  
**Switching losses (typical)**

$$E_{on} = f(R_G), E_{off} = f(R_G), E_{rec} = f(R_G)$$

$V_{GE} = \pm 15V, I_C = 600A, V_{CE} = 600V, T_{vi} = 125^\circ C$

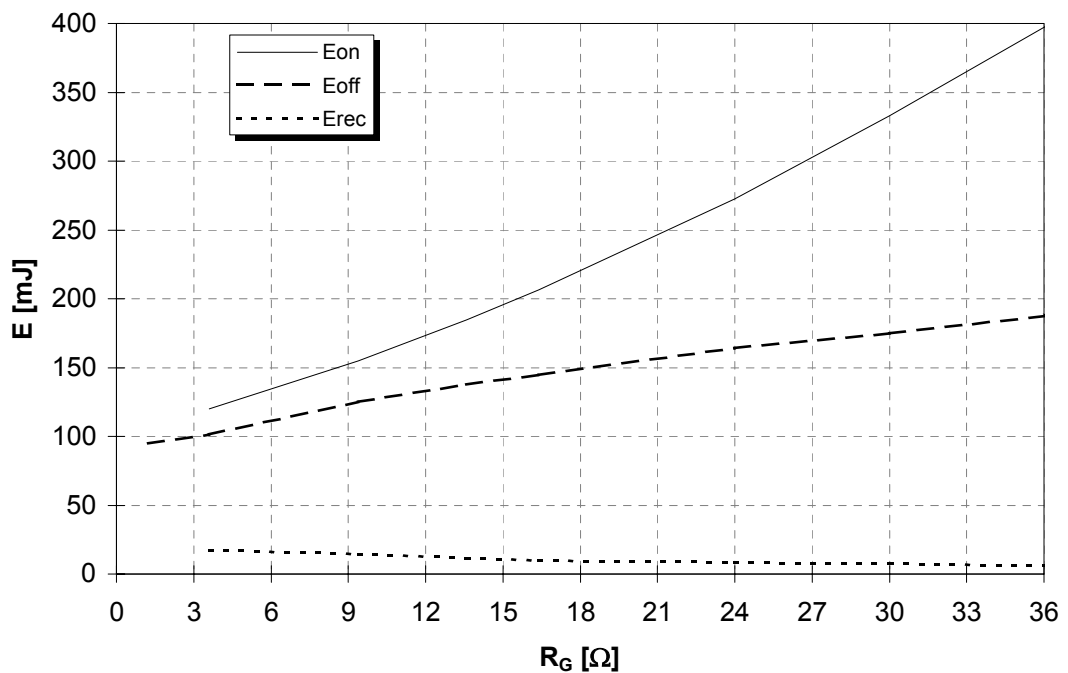



vorläufige Daten  
preliminary data

Transienter Wärmewiderstand  
Transient thermal impedance

$$Z_{thJC} = f(t)$$

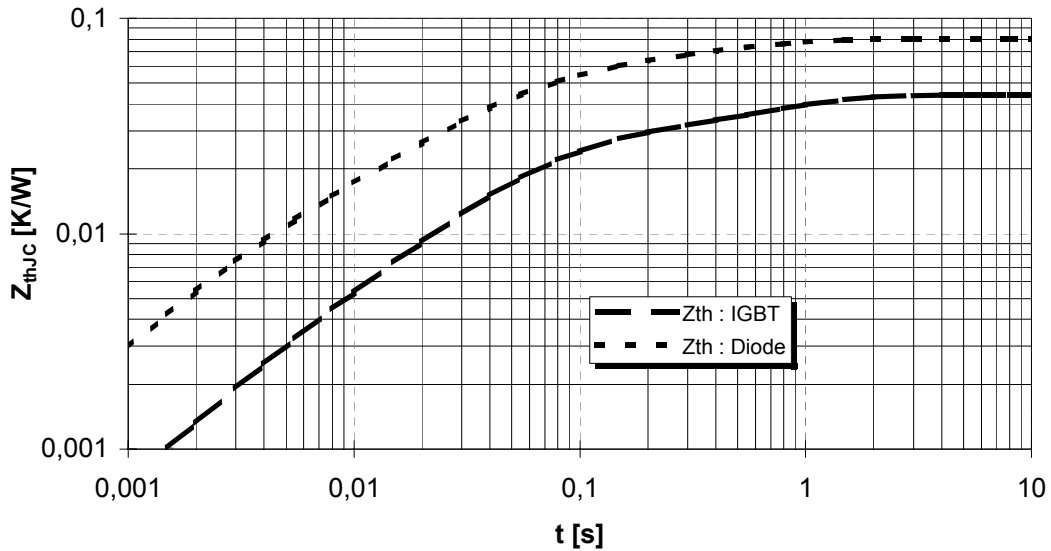

i	1	2	3	4
$r_i$ [K/kW] : IGBT	18,49	22,17	2,51	0,83
$\tau_i$ [s] : IGBT	6,897E-01	5,634E-02	2,997E-02	3,820E-03
$r_i$ [K/kW] : Diode	22,96	25,20	26,46	5,38
$\tau_i$ [s] : Diode	4,452E-01	7,451E-02	2,647E-02	2,850E-03

Sicherer Arbeitsbereich (RBSOA)

Reverse bias safe operation area (RBSOA)

$$V_{GE} = \pm 15V, T_{vj} = 125^\circ C$$

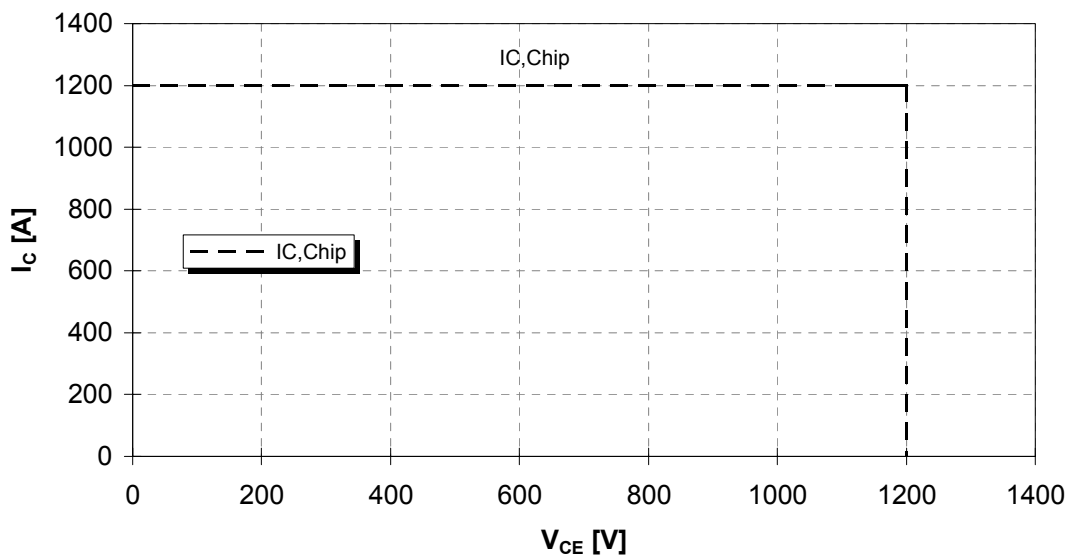

IGBT-Module  
IGBT-Modules

## FF600R12KE3



vorläufige Daten  
preliminary data

### Gehäusemaße / Schaltbild Package outline / Circuit diagram

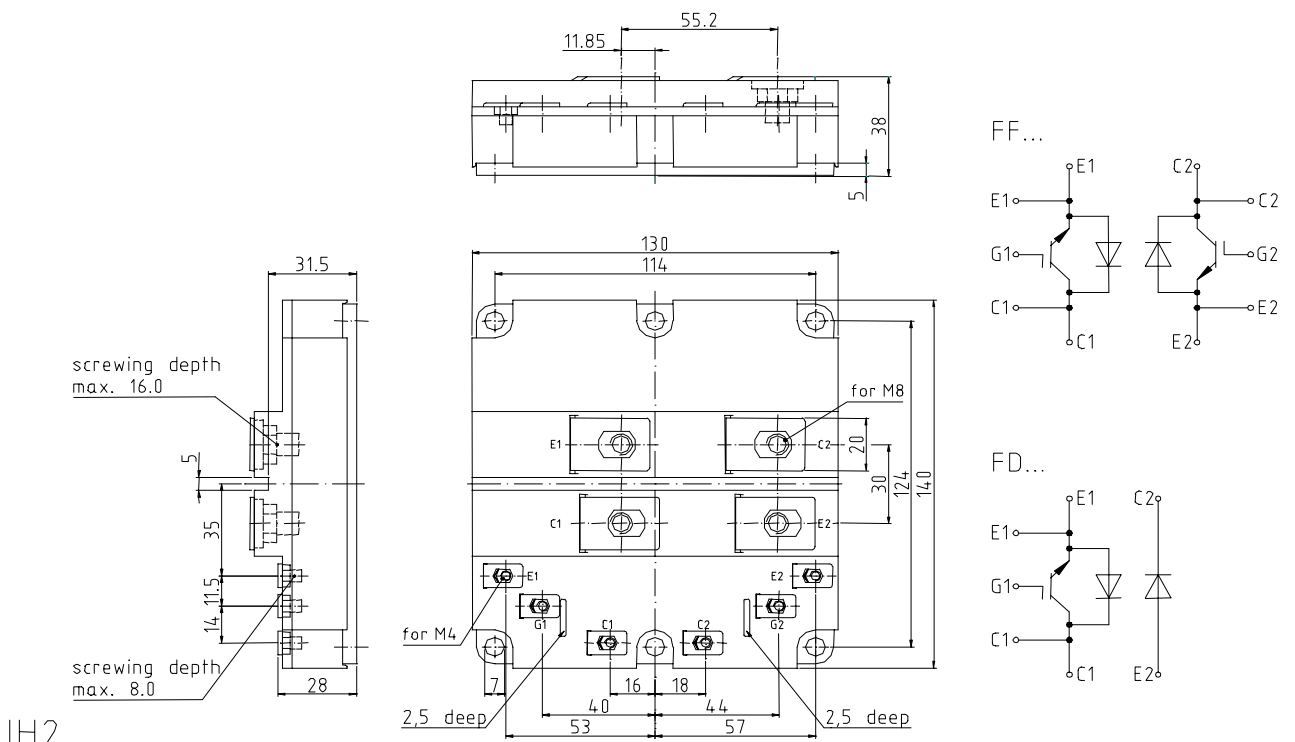

IH2



## **Terms & Conditions of Usage**

### **Attention**

The present product data is exclusively subscribed to technically experienced staff. This Data Sheet is describing the specification of the products for which a warranty is granted exclusively pursuant the terms and conditions of the supply agreement. There will be no guarantee of any kind for the product and its specifications. Changes to the Data Sheet are reserved.

You and your technical departments will have to evaluate the suitability of the product for the intended application and the completeness of the product data with respect to such application. Should you require product information in excess of the data given in the Data Sheet, please contact your local Sales Office via "[www.eupec.com / sales & contact](http://www.eupec.com / sales & contact)".

### **Warning**

Due to technical requirements the products may contain dangerous substances. For information on the types in question please contact your local Sales Office via "[www.eupec.com / sales & contact](http://www.eupec.com / sales & contact)".