

FA57SA50LC

HEXFET® Power MOSFET

- Fully Isolated Package
- Easy to Use and Parallel
- Low On-Resistance
- Dynamic dv/dt Rating
- Fully Avalanche Rated
- Simple Drive Requirements
- Low Gate Charge Device
- Low Drain to Case Capacitance
- Low Internal Inductance

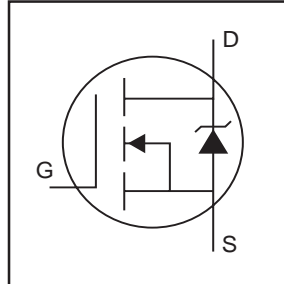

$V_{DSS} = 500V$
$R_{DS(on)} = 0.08\Omega$
$I_D = 57A$

Description

Third Generation HEXFETs from International Rectifier provide the designer with the best combination of fast switching, ruggedized device design, low on-resistance and cost-effectiveness.

The SOT-227 package is universally preferred for all commercial-industrial applications at power dissipation levels to approximately 500 watts. The low thermal resistance of the SOT-227 contribute to its wide acceptance throughout the industry.

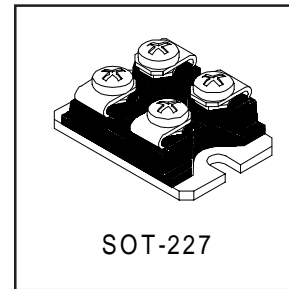

Absolute Maximum Ratings

	Parameter	Max.	Units
$I_D @ T_C = 25^\circ C$	Continuous Drain Current, $V_{GS} @ 10V$	57	A
$I_D @ T_C = 100^\circ C$	Continuous Drain Current, $V_{GS} @ 10V$	36	
I_{DM}	Pulsed Drain Current ①	228	
$P_D @ T_C = 25^\circ C$	Power Dissipation	625	W
	Linear Derating Factor	5.0	W/°C
V_{GS}	Gate-to-Source Voltage	± 20	V
E_{AS}	Single Pulse Avalanche Energy②	725	mJ
I_{AR}	Avalanche Current③	57	A
E_{AR}	Repetitive Avalanche Energy④	62.5	mJ
dv/dt	Peak Diode Recovery dv/dt ⑤	3.0	V/ns
T_J	Operating Junction and	-55 to + 150	°C
T_{STG}	Storage Temperature Range		
V_{ISO}	Insulation Withstand Voltage (AC-RMS)	2.5	kV
	Mounting torque, M4 screw	1.3	N•m

Thermal Resistance

	Parameter	Typ.	Max.	Units
$R_{\theta JC}$	Junction-to-Case	—	0.20	°C/W
$R_{\theta CS}$	Case-to-Sink, Flat, Greased Surface	0.05	—	

Electrical Characteristics @ $T_J = 25^\circ\text{C}$ (unless otherwise specified)

	Parameter	Min.	Typ.	Max.	Units	Conditions
$V_{(BR)DSS}$	Drain-to-Source Breakdown Voltage	500	—	—	V	$V_{GS} = 0V, I_D = 1.0mA$
$\Delta V_{(BR)DSS}/\Delta T_J$	Breakdown Voltage Temp. Coefficient	—	0.62	—	V/°C	Reference to 25°C , $I_D = 1mA$
$R_{DS(on)}$	Static Drain-to-Source On-Resistance	—	—	0.08	Ω	$V_{GS} = 10V, I_D = 34A$ ④
$V_{GS(th)}$	Gate Threshold Voltage	2.0	—	4.0	V	$V_{DS} = V_{GS}, I_D = 250\mu A$
g_{fs}	Forward Transconductance	43	—	—	S	$V_{DS} = 50V, I_D = 34A$
I_{DSS}	Drain-to-Source Leakage Current	—	—	50	μA	$V_{DS} = 500V, V_{GS} = 0V$
		—	—	500		$V_{DS} = 400V, V_{GS} = 0V, T_J = 125^\circ\text{C}$
I_{GSS}	Gate-to-Source Forward Leakage	—	—	200	nA	$V_{GS} = 20V$
	Gate-to-Source Reverse Leakage	—	—	-200		$V_{GS} = -20V$
Q_g	Total Gate Charge	—	225	338	nC	$I_D = 57A$
Q_{gs}	Gate-to-Source Charge	—	51	77		$V_{DS} = 400V$
Q_{gd}	Gate-to-Drain ("Miller") Charge	—	98	147		$V_{GS} = 10V$, See Fig. 6 and 13 ④
$t_{d(on)}$	Turn-On Delay Time	—	32	—	ns	$V_{DD} = 250V$
t_r	Rise Time	—	152	—		$I_D = 57A$
$t_{d(off)}$	Turn-Off Delay Time	—	108	—		$R_G = 2.0\Omega$ (Internal)
t_f	Fall Time	—	118	—		$R_D = 4.3\Omega$, See Fig. 10 ④
L_s	Internal Source Inductance	—	5.0	—	nH	Between lead, and center of die contact
C_{iss}	Input Capacitance	—	10000	—	pF	$V_{GS} = 0V$
C_{oss}	Output Capacitance	—	1500	—		$V_{DS} = 25V$
C_{rss}	Reverse Transfer Capacitance	—	50	—		$f = 1.0MHz$, See Fig. 5

Source-Drain Ratings and Characteristics

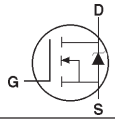
	Parameter	Min.	Typ.	Max.	Units	Conditions
I_S	Continuous Source Current (Body Diode)	—	—	57	A	MOSFET symbol showing the integral reverse p-n junction diode. 
I_{SM}	Pulsed Source Current (Body Diode) ①	—	—	228		
V_{SD}	Diode Forward Voltage	—	—	1.3	V	$T_J = 25^\circ\text{C}, I_S = 57A, V_{GS} = 0V$ ④
t_{rr}	Reverse Recovery Time	—	901	1351	ns	$T_J = 25^\circ\text{C}, I_F = 57A$
Q_{rr}	Reverse Recovery Charge	—	15	23	μC	$di/dt = 100A/\mu s$ ④
t_{on}	Forward Turn-On Time	Intrinsic turn-on time is negligible (turn-on is dominated by $L_S + L_D$)				

Notes:

- ① Repetitive rating; pulse width limited by max. junction temperature. (See fig. 11)
- ② Starting $T_J = 25^\circ\text{C}$, $L = 446\mu H$
 $R_G = 25\Omega$, $I_{AS} = 57A$. (See Figure 12)
- ③ $I_{SD} \leq 57A$, $di/dt \leq 200A/\mu s$, $V_{DD} \leq V_{(BR)DSS}$,
 $T_J \leq 150^\circ\text{C}$
- ④ Pulse width $\leq 300\mu s$; duty cycle $\leq 2\%$.

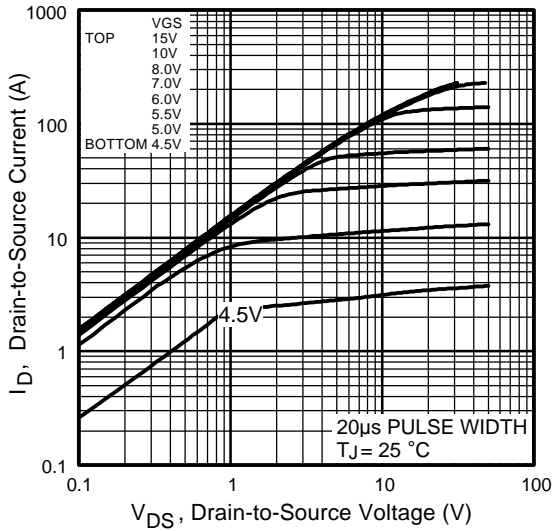

Fig 1. Typical Output Characteristics

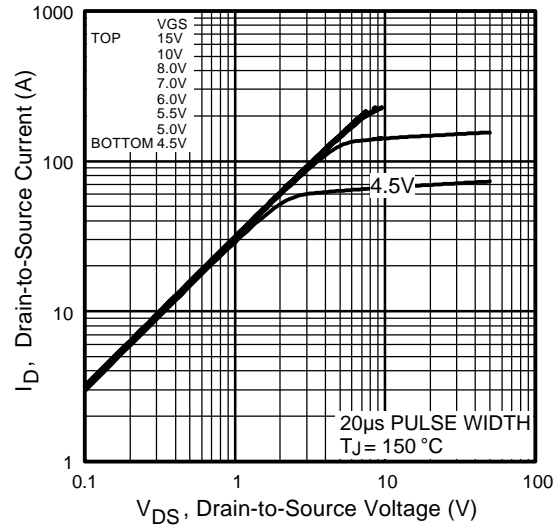

Fig 2. Typical Output Characteristics

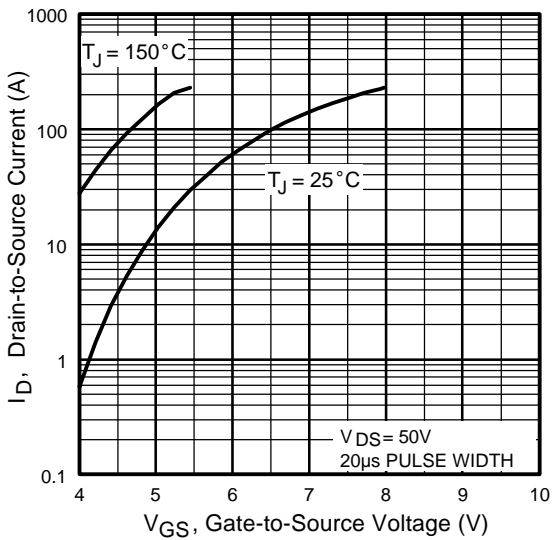

Fig 3. Typical Transfer Characteristics

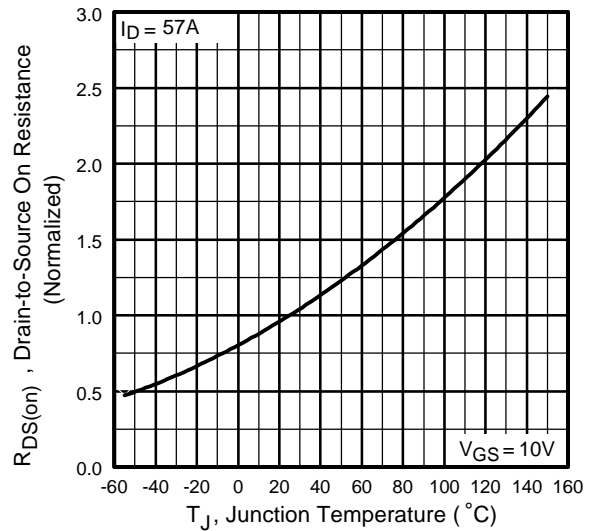

Fig 4. Normalized On-Resistance Vs. Temperature

FA57SA50LC

International
IR Rectifier

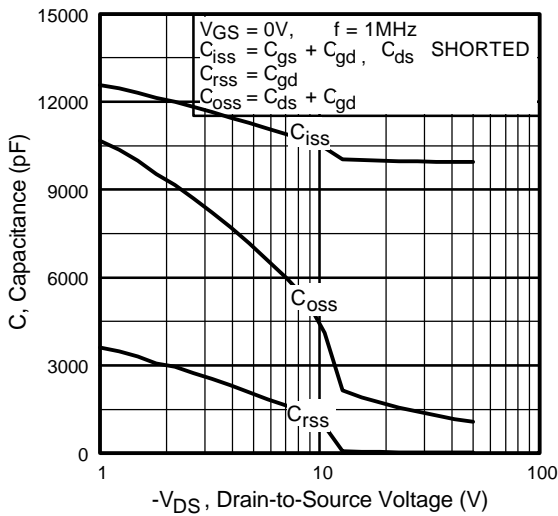

Fig 5. Typical Capacitance Vs. Drain-to-Source Voltage

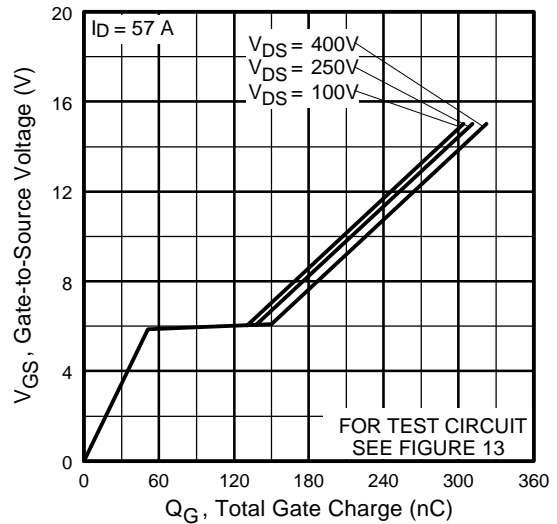

Fig 6. Typical Gate Charge Vs. Gate-to-Source Voltage

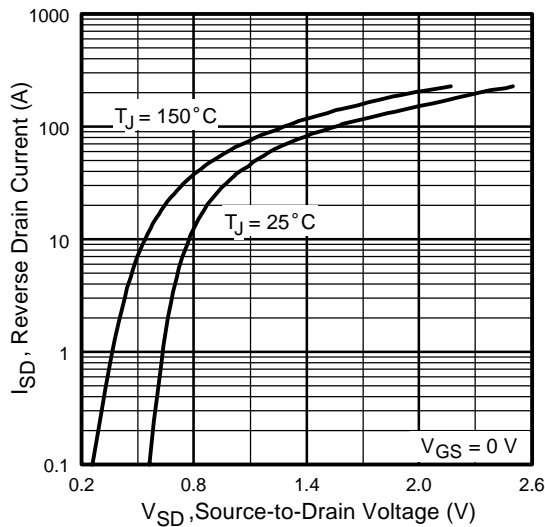

Fig 7. Typical Source-Drain Diode Forward Voltage

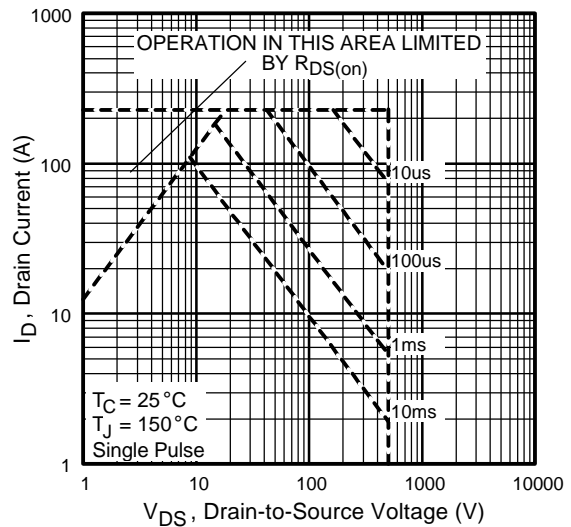

Fig 8. Maximum Safe Operating Area

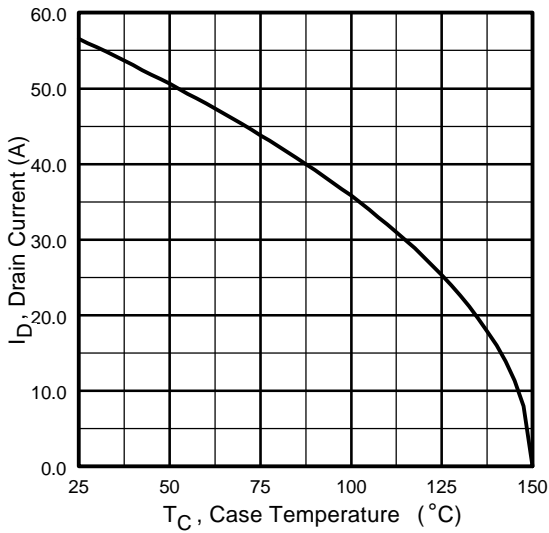

Fig 9. Maximum Drain Current Vs. Case Temperature



Fig 10a. Switching Time Test Circuit



Fig 10b. Switching Time Waveforms

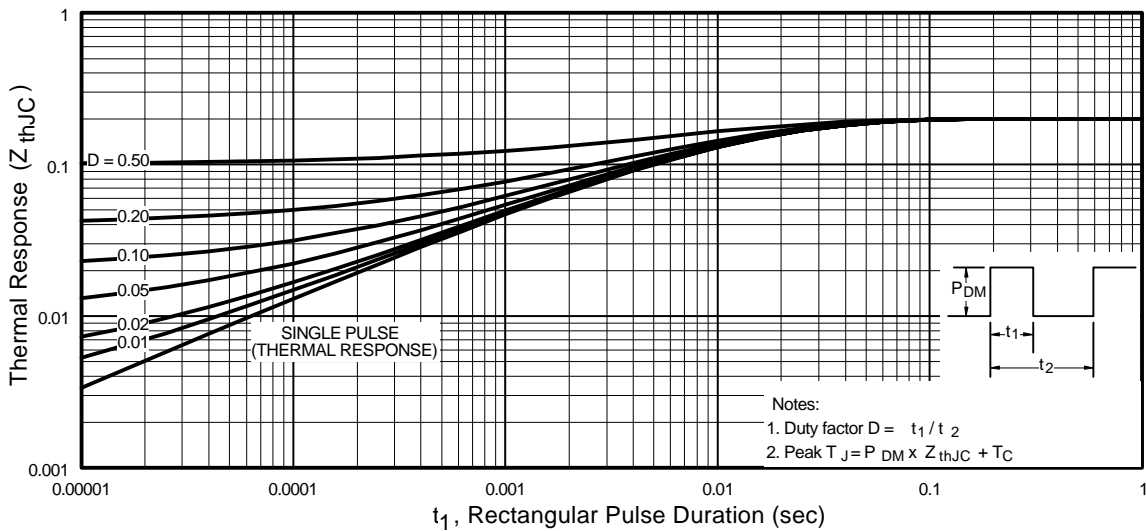

Fig 11. Maximum Effective Transient Thermal Impedance, Junction-to-Case

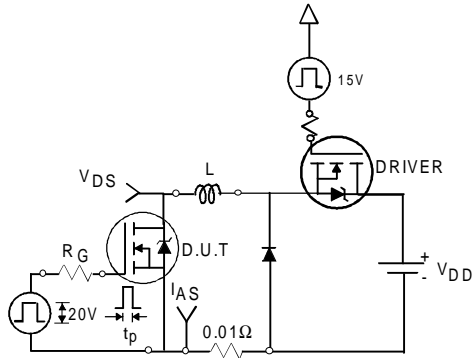

Fig 12a. Unclamped Inductive Test Circuit

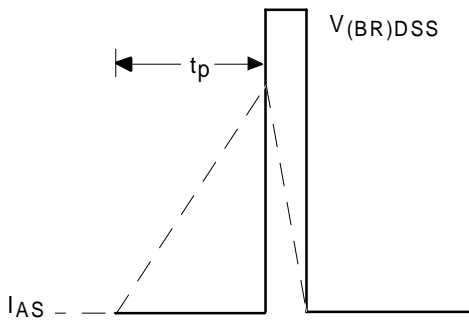

Fig 12b. Unclamped Inductive Waveforms



Fig 13a. Basic Gate Charge Waveform

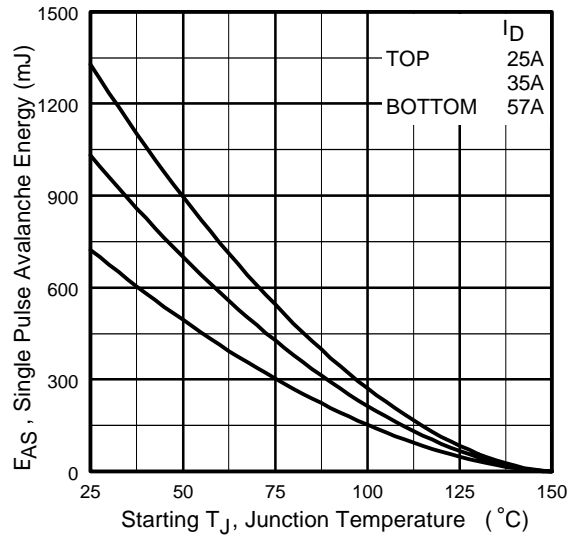

Fig 12c. Maximum Avalanche Energy Vs. Drain Current



Fig 13b. Gate Charge Test Circuit

Peak Diode Recovery dv/dt Test Circuit



* $V_{GS} = 5V$ for Logic Level Devices

Fig 14. For N-Channel HEXFETS

FA57SA50LC

International
IR Rectifier

SOT-227 Package Details

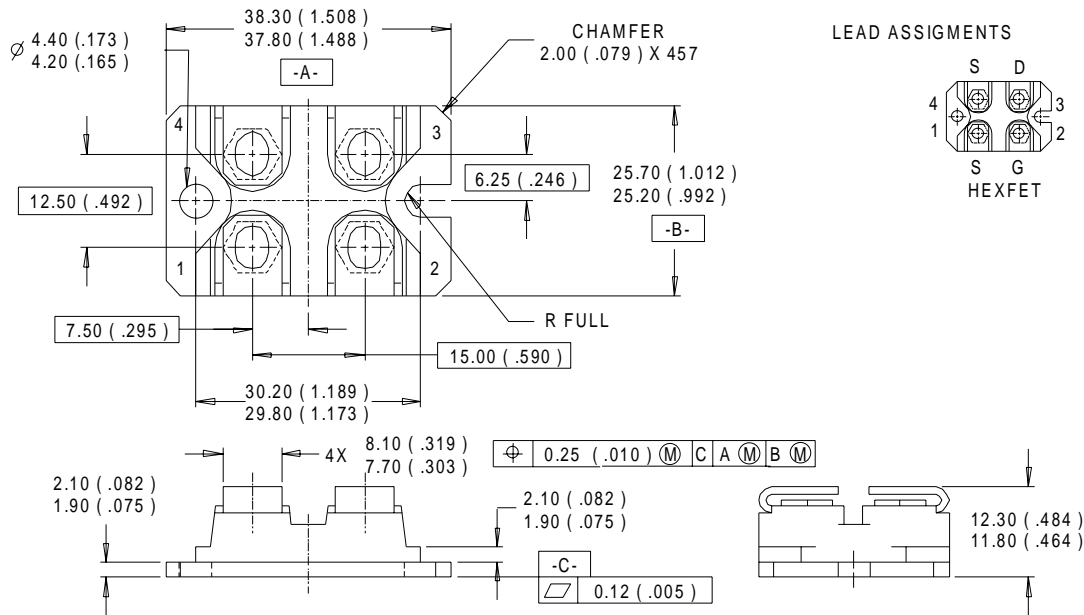

Tube

QUANTITY PER TUBE IS 10
M4 SREW AND WASHER INCLUDED

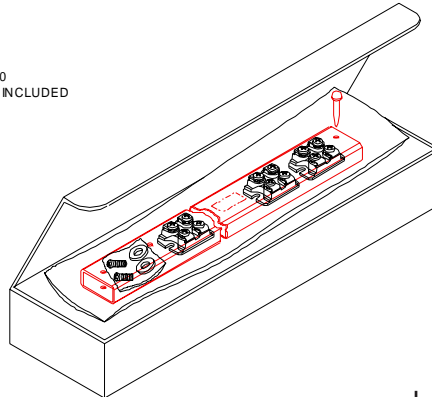

International
IR Rectifier

WORLD HEADQUARTERS: 233 Kansas St., El Segundo, California 90245, Tel: (310) 322 3331

IR GREAT BRITAIN: Hurst Green, Oxted, Surrey RH8 9BB, UK Tel: ++ 44 1883 732020

IR CANADA: 15 Lincoln Court, Brampton, Ontario L6T3Z2, Tel: (905) 453 2200

IR GERMANY: Saalburgstrasse 157, 61350 Bad Homburg Tel: ++ 49 6172 96590

IR ITALY: Via Liguria 49, 10071 Borgaro, Torino Tel: ++ 39 11 451 0111

IR FAR EAST: K&H Bldg., 2F, 30-4 Nishi-Ikebukuro 3-Chome, Toshima-Ku, Tokyo Japan 171 Tel: 81 3 3983 0086

IR SOUTHEAST ASIA: 1 Kim Seng Promenade, Great World City West Tower, 13-11, Singapore 237994 Tel: ++ 65 838 4630

IR TAIWAN: 16 Fl. Suite D. 207, Sec. 2, Tun Haw South Road, Taipei, 10673, Taiwan Tel: 886-2-2377-9936

<http://www.irf.com/> Data and specifications subject to change without notice. 2/99