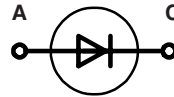
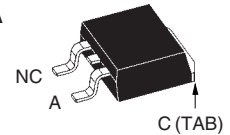

Fast Recovery Epitaxial Diode (FRED)

$V_{RRM} = 600\text{ V}$
 $I_{FAVM} = 20\text{ A}$
 $t_{rr} = 35\text{ ns}$

V_{RSM}	V_{RRM}	Type
V	V	
600	600	DSEI 19-06AS

TO-263 AA

A = Anode, C = Cathode,
NC = No connection, TAB = Cathode

Symbol	Conditions	Maximum Ratings	
I_{FRMS}	$T_{VJ} = T_{VJM}$	25	A
I_{FAVM} ①	$T_C = 65^\circ\text{C}$; rectangular, $d = 0.5$	20	A
I_{FRM}	$t_p < 10\ \mu\text{s}$; rep. rating, pulse width limited by T_{VJM}	150	A
I_{FSM}	$T_{VJ} = 45^\circ\text{C}$; $t = 10\text{ ms}$ (50 Hz), sine	100	A
	$t = 8.3\text{ ms}$ (60 Hz), sine	110	A
	$T_{VJ} = 150^\circ\text{C}$; $t = 10\text{ ms}$ (50 Hz), sine	85	A
	$t = 8.3\text{ ms}$ (60 Hz), sine	95	A
I^2t	$T_{VJ} = 45^\circ\text{C}$ $t = 10\text{ ms}$ (50 Hz), sine	50	A^2s
	$t = 8.3\text{ ms}$ (60 Hz), sine	50	A^2s
	$T_{VJ} = 150^\circ\text{C}$; $t = 10\text{ ms}$ (50 Hz), sine	36	A^2s
	$t = 8.3\text{ ms}$ (60 Hz), sine	37	A^2s
T_{VJ}		-40...+150	$^\circ\text{C}$
T_{VJM}		150	$^\circ\text{C}$
T_{stg}		-40...+150	$^\circ\text{C}$
P_{tot}	$T_C = 25^\circ\text{C}$	61	W
Weight		2	g

Features

- International standard surface mount package JEDEC TO-263 AA
- Planar passivated chips
- Very short recovery time
- Extremely low switching losses
- Low I_{RM} -values
- Soft recovery behaviour
- Epoxy meets UL 94V-0

Symbol	Conditions	Characteristic Values	
		typ.	max.
I_R	$T_{VJ} = 25^\circ\text{C}$; $V_R = V_{RRM}$	50	μA
	$T_{VJ} = 25^\circ\text{C}$; $V_R = 0.8 \cdot V_{RRM}$	25	μA
	$T_{VJ} = 125^\circ\text{C}$; $V_R = 0.8 \cdot V_{RRM}$	3	mA
V_F	$I_F = 16\text{ A}$; $T_{VJ} = 150^\circ\text{C}$	1.5	V
	$T_{VJ} = 25^\circ\text{C}$	1.7	V
V_{T0}	For power-loss calculations only	1.12	V
r_T	$T_{VJ} = T_{VJM}$	23.2	m Ω
R_{thJC}		2	K/W
t_{rr}	$I_F = 1\text{ A}$; $-di/dt = 50\text{ A}/\mu\text{s}$; $V_R = 30\text{ V}$; $T_{VJ} = 25^\circ\text{C}$	35	50 ns
I_{RM}	$V_R = 350\text{ V}$; $I_F = 12\text{ A}$; $-di_F/dt = 100\text{ A}/\mu\text{s}$ $L \leq 0.05\ \mu\text{H}$; $T_{VJ} = 100^\circ\text{C}$	4	4.4 A

① I_{FAVM} rating includes reverse blocking losses at T_{VJM} , $V_R = 0.8 V_{RRM}$, duty cycle $d = 0.5$
Data according to IEC 60747

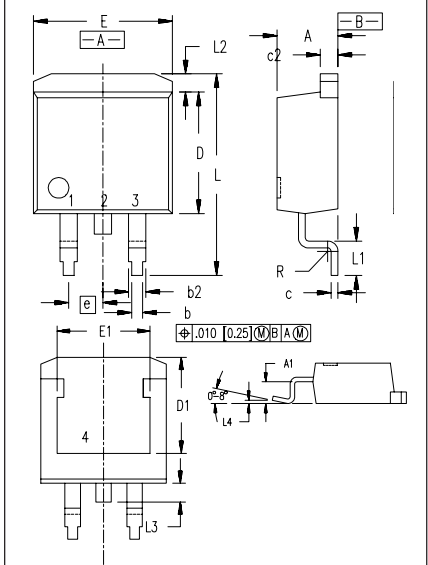
TO-263 AA Outline

Dim.	Millimeter		Inches	
	Min.	Max.	Min.	Max.
A	4.06	4.83	.160	.190
A1	2.03	2.79	.080	.110
b	0.51	0.99	.020	.039
b2	1.14	1.40	.045	.055
c	0.46	0.74	.018	.029
c2	1.14	1.40	.045	.055
D	8.64	9.65	.340	.380
D1	7.11	8.13	.280	.320
E	9.65	10.29	.380	.405
E1	6.86	8.13	.270	.320
e	2.54	BSC	.100	BSC
L	14.61	15.88	.575	.625
L1	2.29	2.79	.090	.110
L2	1.02	1.40	.040	.055
L3	1.27	1.78	.050	.070
L4	0	0.38	0	.015
R	0.46	0.74	.018	.029

IXYS reserves the right to change limits, test conditions and dimensions

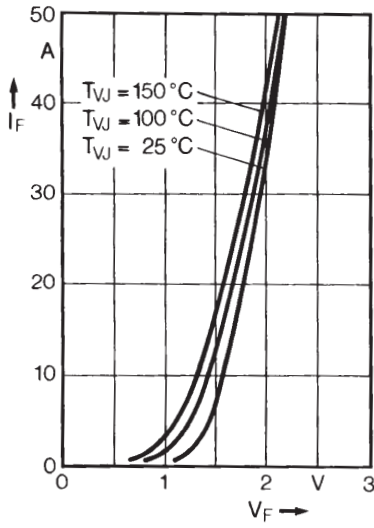

Fig. 1 Forward current versus voltage drop.

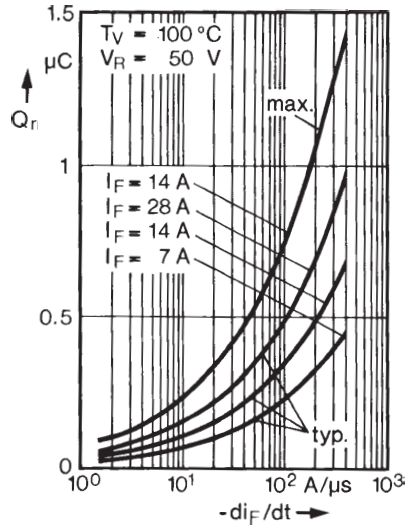

Fig. 2 Recovery charge versus $-di_F/dt$.

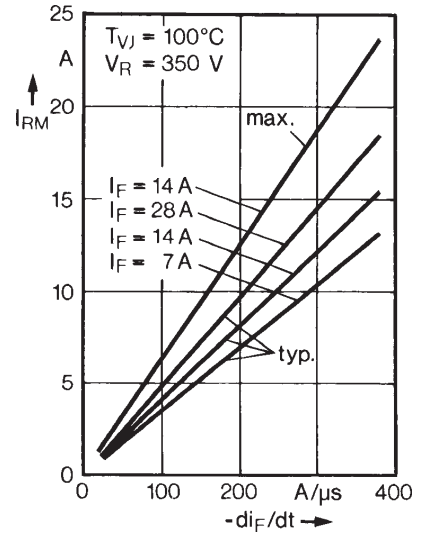

Fig. 3 Peak reverse current versus $-di_F/dt$.

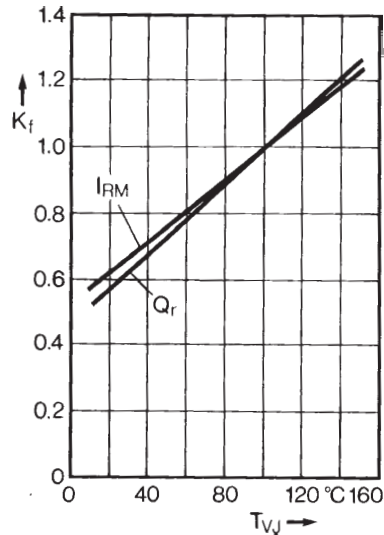

Fig. 4 Dynamic parameters versus junction temperature.

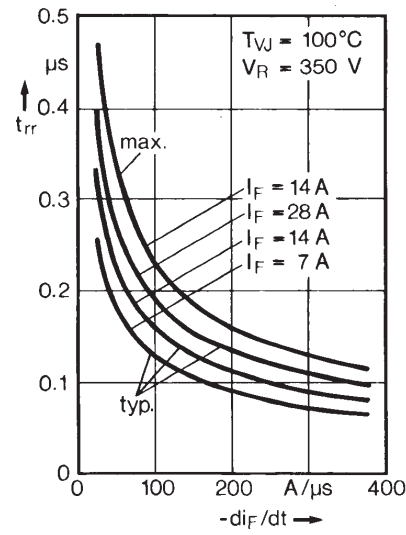

Fig. 5 Recovery time versus $-di_F/dt$.

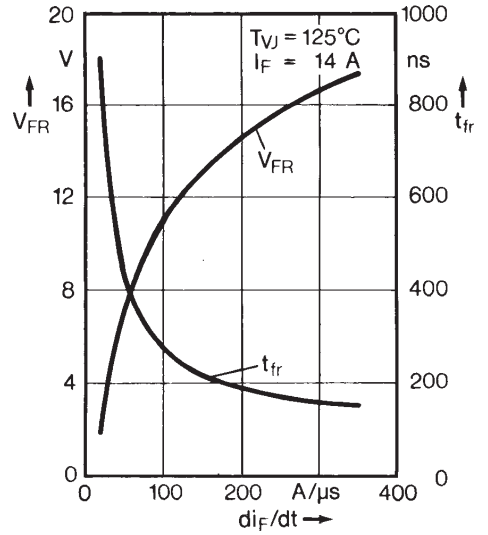

Fig. 6 Peak forward voltage versus di_F/dt .

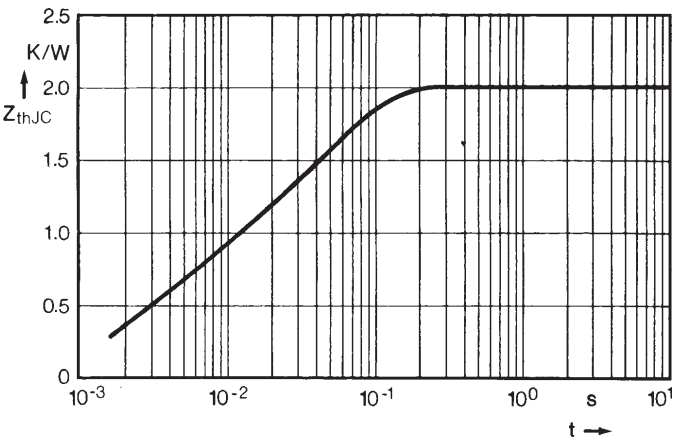

Fig. 7 Transient thermal impedance junction to case.