



HIGH SPEED NPN POWER DARLINGTON TRANSISTORS

D67DE5,6,7

**500-700 VOLTS
100 AMP, 312.5 WATTS**

The General Electric D67DE is a high current power darlington. It features collector isolation from the heat sink, an internal construction designed for stress-free operation at temperature extremes, hefty screw terminals for emitter and collector connection and quick electrical terminals for B1 and B2. The device is designed to meet UL creep, strike and isolation voltage. Major applications are for motor controls, switching power supplies and UPS systems.

Features:

- High Voltage: 400-500 V_{CEO(sus)}; 500-700 V_{CEV}
- High Current: 150 Amperes, I_C (Peak)
- High Gain: h_{FE} 50 Minimum @ 100 Amperes I_C (h_{FE} 200 typical)
- Both Base 1 and Base 2 connections are available
- UL recognized industrial package

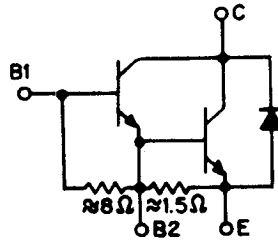

DEVICE CIRCUIT

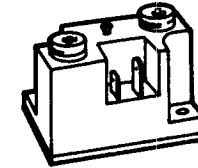

CASE STYLE D67
DIMENSIONS ARE IN INCHES AND
(MILLIMETERS)

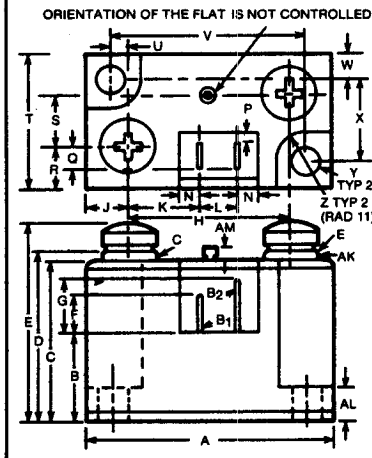

SYMBOL	INCHES		METRIC	
	MIN	MAX	MIN	MAX
A	1.785	1.815	45.33	45.10
B	.815	.885	18.82	17.40
C	11.48	11.58	28.15	29.43
D	1.215	1.270	30.88	32.26
E	—	1.470	—	37.34
F	.245	—	6.20	—
G	.335	—	8.50	—
H	1.170	1.190	29.71	30.23
J	.295	.325	7.50	8.26
K	.518	REF.	13.16	REF.
L	.280	.290	6.90	7.37
N	.190	REF.	3.81	REF.
P	.070	REF.	1.80	REF.
Q	.170	REF.	4.30	REF.
R	.300	.320	7.60	8.13
S	.370	.390	9.40	9.90
T	.885	1.016	25.00	25.80
U	.110	.130	2.80	3.30
V	1.418	1.430	35.80	36.32
W	.178	.205	4.44	5.20
X	.610	.630	15.50	16.00
Y	.189	.221	4.80	5.61
Z	.190	.230	4.82	5.84
AA	.047	REF.	1.20	REF.
AB	.312	REF.	7.93	REF.
AC	N63 (MED FIT)	N63 (MED FIT)	—	—
AD	.191	.193	4.87	4.90
AE	.051	.054	.78	.86
AF	.118	.132	3.02	3.35
AG	.090	.090	1.27	1.62
AH	.068	.076	1.68	1.90
AJ	.204	.211	5.18	5.28
AK	.385	.395	9.77	9.90
AL	.238	.285	5.98	6.73
AM	—	.125	—	3.20

maximum ratings (T_C = 25°C) (unless otherwise noted)

RATING	SYMBOL	D67DE5	D67DE6	D67DE7	UNITS
Collector-Base Voltage	V _{CBO}	500	600	700	Volts
Collector-Emitter Voltage	V _{CEO}	400	450	500	Volts
Emitter Base Voltage	V _{EBO}	8	8	8	Volts
Collector Current — Continuous	I _C	100	100	100	A
Peak (Repetitive)	I _{CM}	150	150	150	
Peak (Non-Repetitive)	I _{CSM}	250	250	250	
Base Current — Continuous	I _B	10	10	10	A
Peak (Non-Repetitive)	I _{BM}	20	20	20	
Total Power Dissipation @ T _C = 25°C	P _D	312.5	312.5	312.5	Watts
Operating and Storage Junction Temperature Range	T _J , T _{STG}	-40 to +150	-40 to +150	-40 to +150	°C
Isolation Voltage	V _{ISOL}	2500	2500	2500	V(rms)

thermal characteristics

Thermal Resistance, Junction to Case	R _{θJC}	4	4	4	°C/W
--------------------------------------	------------------	---	---	---	------

See page 845 for mounting and handling considerations.

electrical characteristics ($T_C = 25^\circ\text{C}$) (unless otherwise specified)

CHARACTERISTIC	SYMBOL	MIN	TYP	MAX	UNIT
----------------	--------	-----	-----	-----	------

off characteristics

Collector-Emitter Sustaining Voltage ($I_C = 1\text{A}$) ($V_{\text{clamp}} = V_{\text{CEO}}$, $R_{\text{BE}} = 10\Omega$)	D67DE5 D67DE6 D67DE7	$V_{\text{CEO(sus)}}$	400 450 500	— — —	— — —	Volts
Collector Cutoff Current ($V_{\text{CEV}} = \text{Rated Value}$, $V_{\text{BE(off)}} = 1.5\text{V}$)	$T_J = 25^\circ\text{C}$ $T_J = 150^\circ\text{C}$	I_{CEV}	— —	— —	1.0 2.5	mA
Emitter Cutoff Current ($V_{\text{EB}} = 3.5\text{V}$, $I_C = 0$)		I_{EBO}	—	—	500	mA

second breakdown

Second Breakdown with Base Forward Biased	FBSOA	SEE FIGURE 16
---	-------	---------------

on characteristics

DC Current Gain ($I_C = 150\text{A}$, $V_{\text{CE}} = 5\text{V}$) ($I_C = 100\text{A}$, $V_{\text{CE}} = 5\text{V}$) ($I_C = 40\text{A}$, $V_{\text{CE}} = 5\text{V}$)	h_{FE}	25 50 100	90 200 275	— — —	—
Collector-Emitter Saturation Voltage ($I_C = 150\text{A}$, $I_B = 10\text{A}$) ($I_C = 100\text{A}$, $I_B = 8\text{A}$) ($I_C = 40\text{A}$, $I_B = 4\text{A}$)	$V_{\text{CE(sat)}}$	— — —	1.9 1.4 1.0	3.0 2.0 1.5	V
Base-Emitter Saturation Voltage ($I_C = 150\text{A}$, $I_B = 10\text{A}$) ($I_C = 100\text{A}$, $I_B = 8\text{A}$)	$V_{\text{BE(sat)}}$	— —	2.75 2.3	3.5 3.0	V

switching characteristics

Resistive Load						
Delay Time	$V_{\text{CC}} = 250\text{V}$ $I_C = 100\text{A}$ $I_{\text{B1}} = 5\text{A}$, $I_{\text{B2}} = 10\text{A}$	t_d	—	.105	0.5	μs
Rise Time		t_r	—	.45	1.0	
Storage Time		t_s	—	3.2	5.0	
Fall Time		t_f	—	1.1	3.0	

emitter-collector diode characteristics

Forward Voltage ($I_F = 100\text{A}$) ($T_J = 25^\circ\text{C}$) ($T_J = 150^\circ\text{C}$)	V_F V_F	— —	1.9 1.75	3.25 3.00	Volts Volts
Reverse Recovery Time ($I_F = 100\text{A}$, $di/dt = 25\text{A}/\mu\text{sec}$, $R_{\text{B1E}} = .25\Omega$) ($T_J = 25^\circ\text{C}$)	T_{rr}	—	4.5	10.0	μsec
Forward Turn-On Time ($I_F = 100\text{A}$, $di/dt = 100\text{A}/\mu\text{sec}$) ($T_J = 25^\circ\text{C}$)	T_{ON}	—	1.7	2.5	μsec
Thermal Resistance	$R_{\theta\text{JC}}$	—	—	0.4	$^\circ\text{C}/\text{Watt}$

TYPICAL CHARACTERISTICS

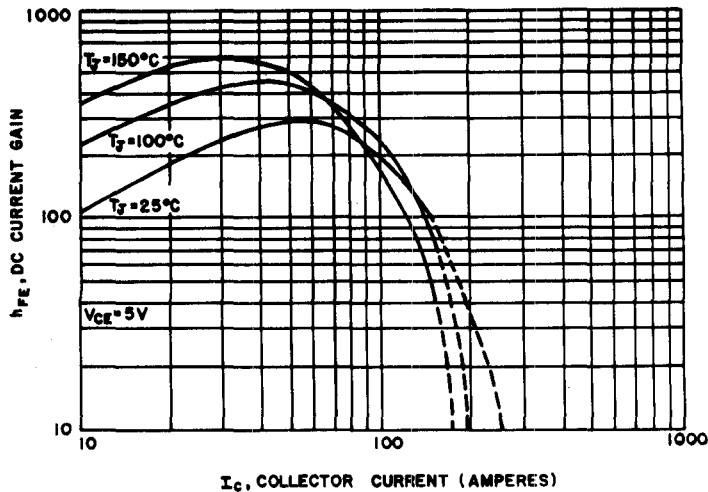

FIGURE 1: DC CURRENT GAIN ($V_{CE} = 5V$)

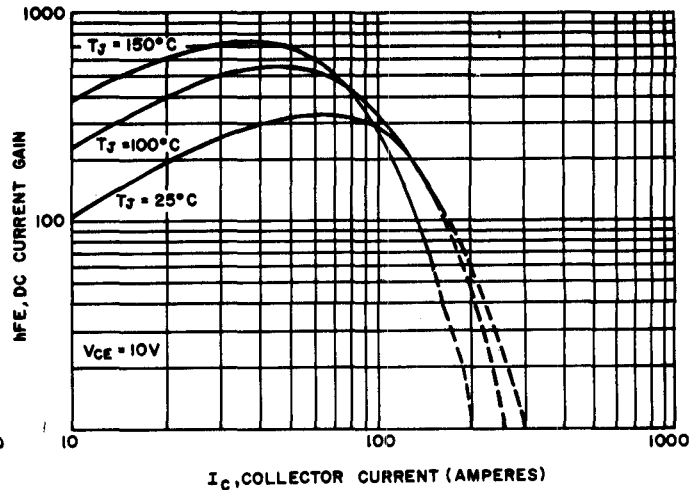

FIGURE 2: DC CURRENT GAIN ($V_{CE} = 10V$)

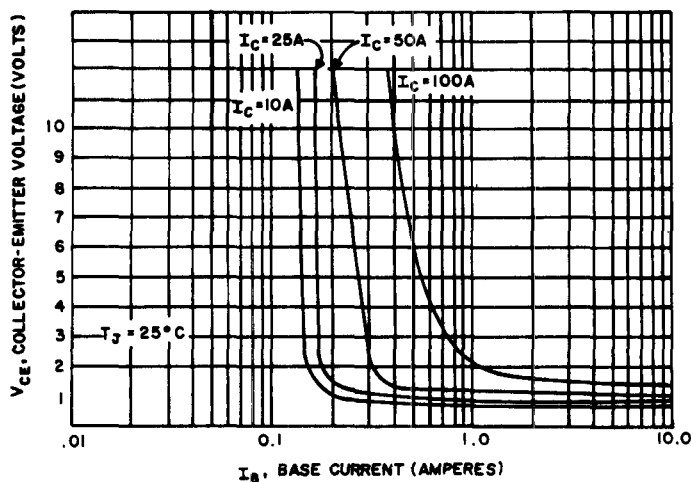

FIGURE 3: COLLECTOR SATURATION REGION

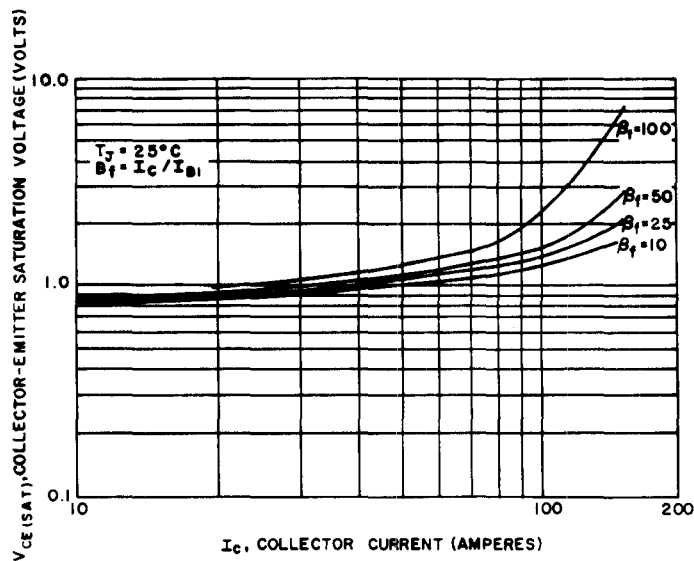

FIGURE 4: $V_{CE(SAT)}$ VS I_C , $T_J = 25^\circ C$

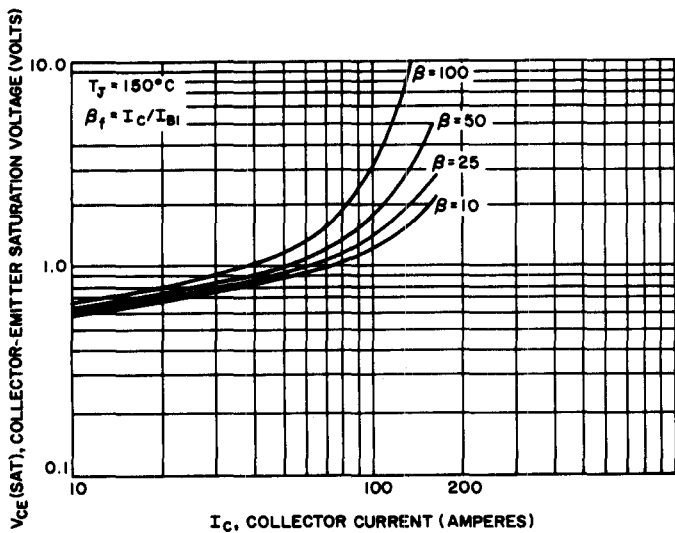

FIGURE 5: $V_{CE(SAT)}$ VS I_C , $T_J = 150^\circ C$

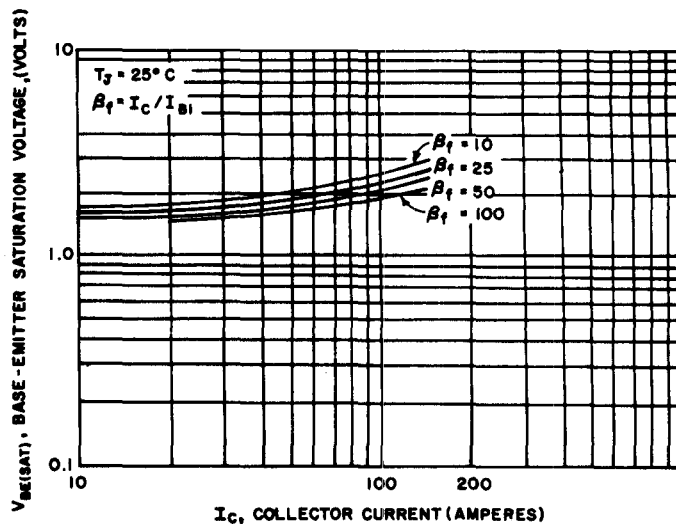

FIGURE 6: $V_{BE(SAT)}$ VS I_C , $T_J = 25^\circ C$

TYPICAL CHARACTERISTICS

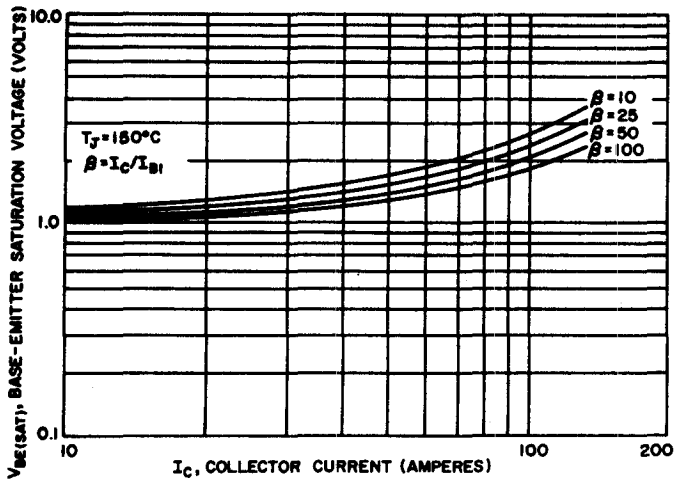

FIGURE 7: $V_{BE(SAT)}$ VS I_C , $T_J=150^\circ\text{C}$

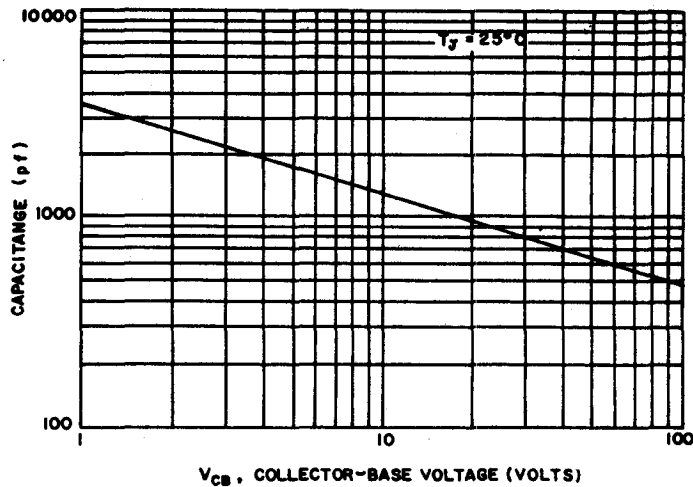

FIGURE 8: CAPACITANCE (C_{CBO})

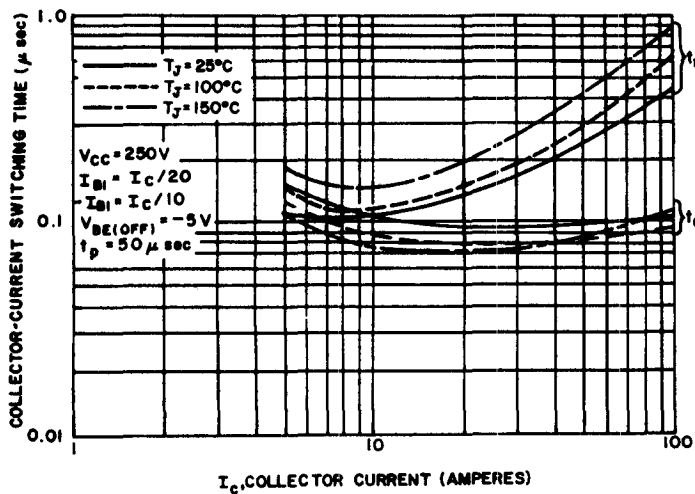

FIGURE 9: TURN-ON TIME (RESISTIVE LOAD)

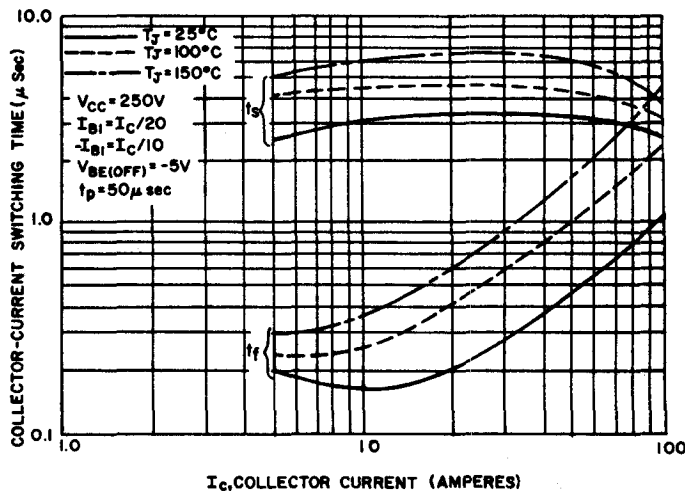

FIGURE 10: TURN-OFF TIME (RESISTIVE LOAD)

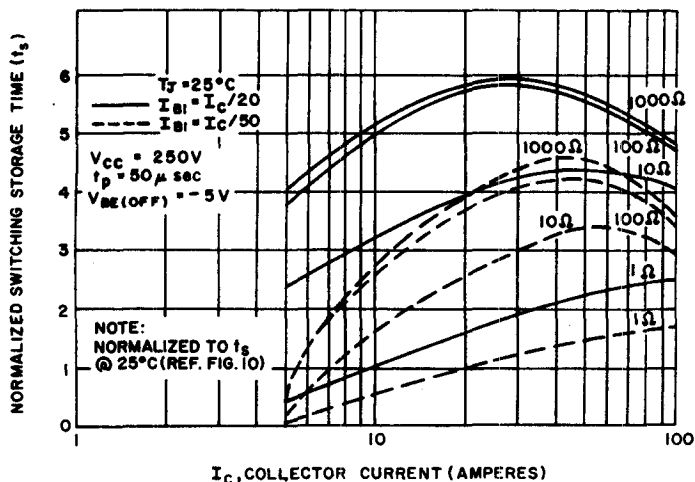

FIGURE 11: NORMALIZED RESISTIVE SWITCHING STORAGE TIME (R_{BE} VARIATIONS) VS COLLECTOR CURRENT

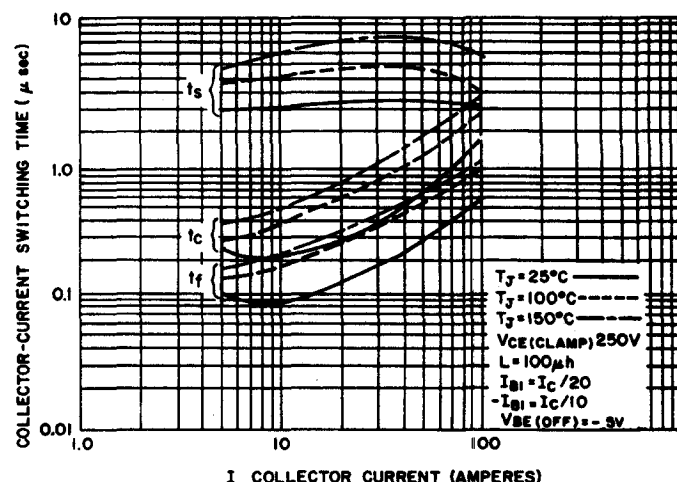

FIGURE 12: CLAMPED INDUCTIVE TURN-OFF TIME

TYPICAL CHARACTERISTICS

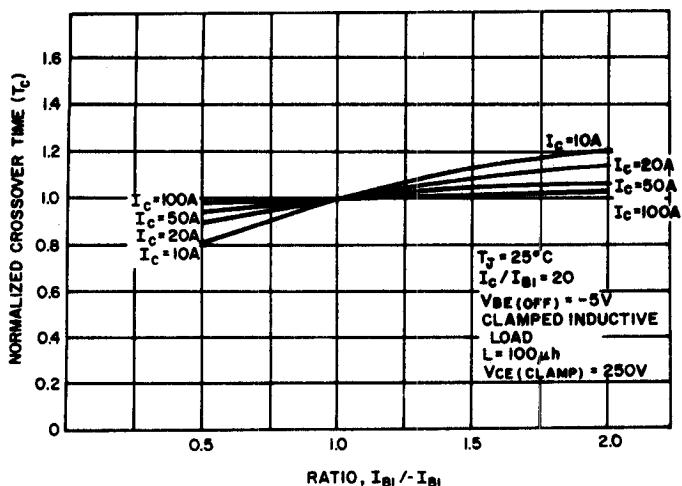

FIGURE 13: CROSSOVER TIME VARIATION WITH $-I_{B1}$

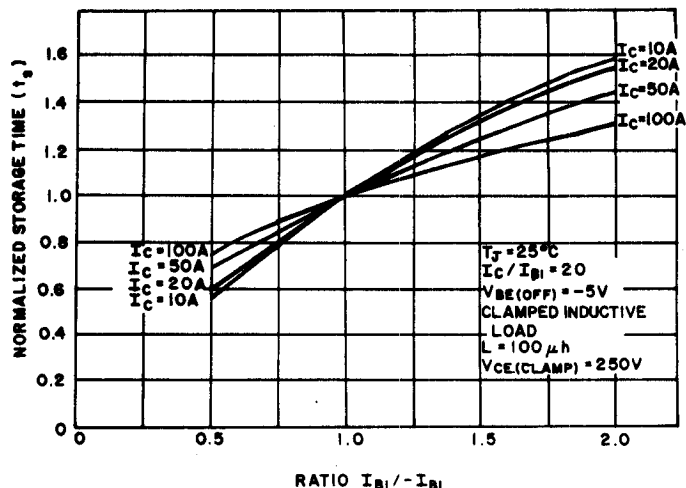

FIGURE 14: STORAGE TIME VARIATION WITH $-I_{B1}$

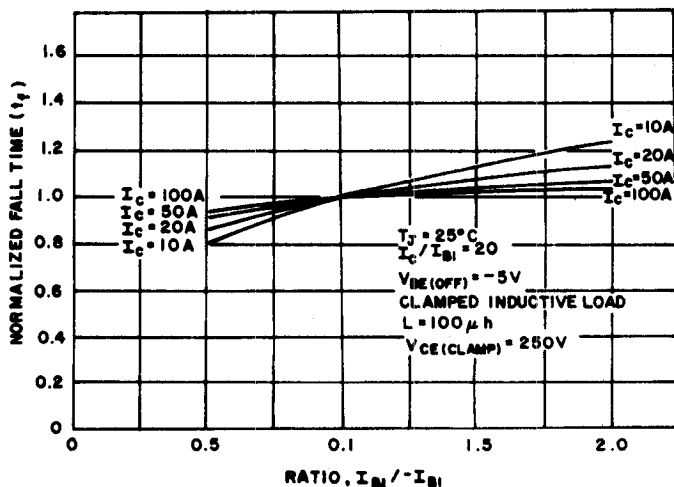

FIGURE 15: FALL TIME VARIATION WITH $-I_{B1}$

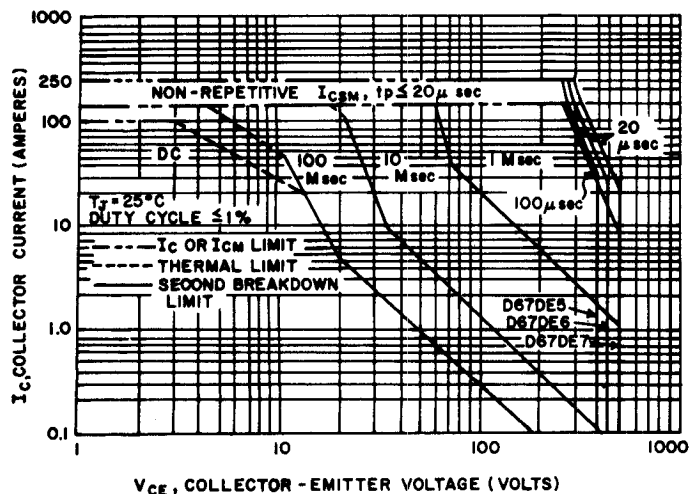

FIGURE 16: FORWARD BIAS SAFE OPERATING AREA

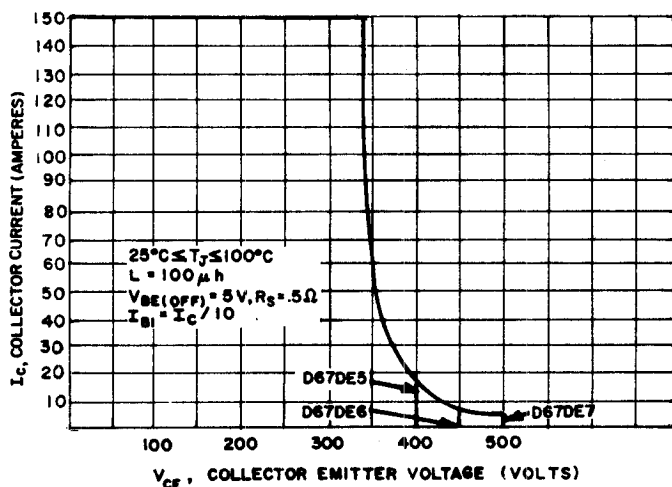

FIGURE 17: REVERSE BIAS SAFE OPERATING AREA (CLAMPED)

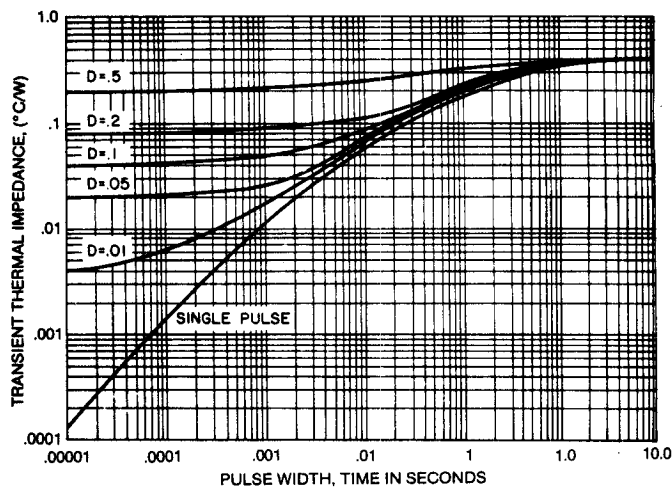

FIGURE 18: TRANSIENT THERMAL RESPONSE

TYPICAL CHARACTERISTICS

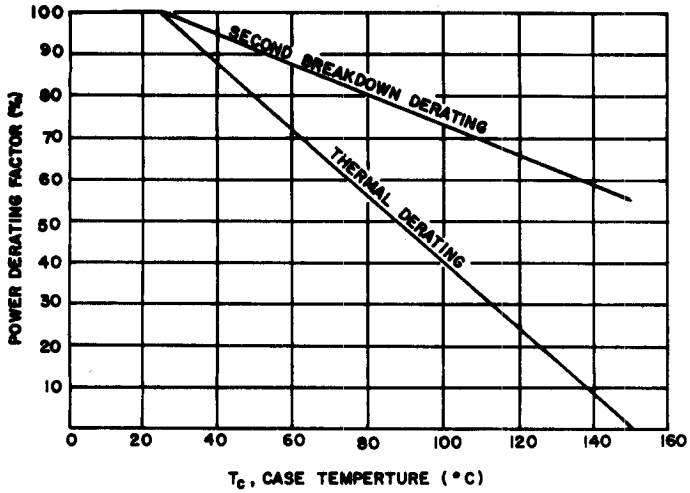

FIGURE 19: POWER DERATING

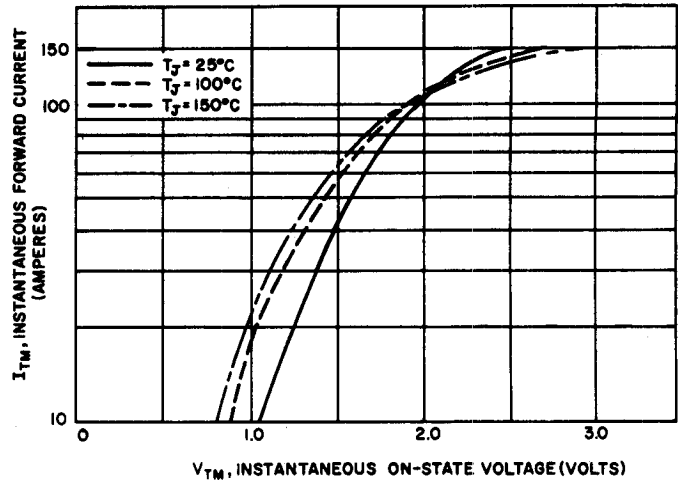

FIGURE 20: DIODE FORWARD CHARACTERISTICS

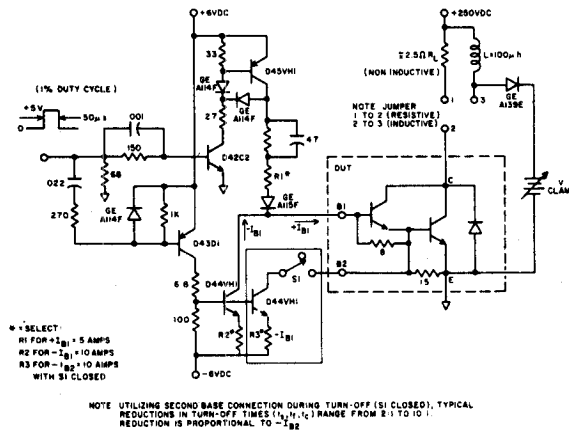

FIGURE 21: SWITCHING TIME TEST CIRCUITS FOR:
 • RESISTIVE & INDUCTIVE SWITCHING
 • USING BASE 1 ONLY
 • USING BASE 1 AND BASE 2