



Applications

- Motor Control
- Overvoltage Crowbar Protection
- Capacitive Discharge Ignition
- Voltage Regulation
- Welding Equipment
- Capacitive Filter Soft Start (Inrush Current Control)

- > Suitable for General Purpose AC Switching
- > IGT 40mA Max.
- > Isolated and Non-Isolated Tab
- > VDRM/VRMM 400, 600, 800, 1000V

CYNA/CYNB25

25Amp - 400/600/800/1000V - SCR

Absolute Maximum Ratings

	CONDITIONS	SYMBOL	RATING
RMS On-State Current (full sine wave)	$T_c = 100^\circ\text{C}$ $T_c = 75^\circ\text{C}$	TO-220AB TO-220AB Iso $I_{T(RMS)}$	25A
Average On-State Current	$T_c = 100^\circ\text{C}$ $T_c = 75^\circ\text{C}$	TO-220AB TO-220AB Iso $I_{T(AV)}$	16A
Non Repetitive Surge Peak On-State Current (Full Cycle, T_j Initial = 25°C)	F = 50 Hz F = 60 Hz	I_{TSM}	320A 350A
I^2t Value for fusing	$t_p = 10$ ms	I^2t	510A ² s
Critical rate of rise of on-state current $I_G = 2 \times I_{GT}$, $t_r < 100$ ns, $T_j = 125^\circ\text{C}$		di/dt	100A/ μ s
Peak Gate Current @ $T_j = 125^\circ\text{C}$	$t_p = 20$ μ s	I_{GM}	4A
Average Gate Power Dissipation @ $T_j = 125^\circ\text{C}$		PG(AV)	1W
Storage Temperature Range		T_{stg}	-40 to +150 $^\circ\text{C}$
Operating Junction Temperature Range		T_j	-40 to +125 $^\circ\text{C}$
Isolation Voltage (CYNA Series only)		V_{ISO}	2500V _{RMS}
Maximum Peak Reverse Gate Voltage		V_{RGM}	5V

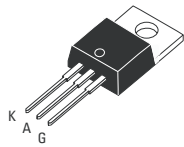

TO-220AB Isolated (CYNA25)

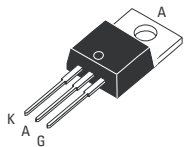

TO-220AB Non-Isolated (CYNB25)

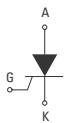

Electrical Characteristics ^{NOTE 1}

I_{GT} MAX @ $V_D = 12$ V, $R_L = 30\Omega$		40mA
V_{GT} MAX @ $V_D = 12$ V, $R_L = 30\Omega$		1.3V
V_{GD} MIN @ $V_D = V_{DRM}$, $R_L = 3.3k\Omega$	$T_j = 125^\circ\text{C}$	0.2V
I_H MAX @ $I_T = 500$ mA (gate open)		50mA
I_L MAX @ $I_G = 1.2 I_{GT}$		90mA
dv/dt MIN @ $V_D = 67\%V_{DRM}$ (gate open)	$T_j = 125^\circ\text{C}$	1000V/ μ s
V_{TM} MAX @ $I_{TM} = 50$ A, $t_p = 380\mu$ s	$T_j = 25^\circ\text{C}$	1.6V
I_{DRM} MAX @ $V_{DRM} = V_{RRM}$	$T_j = 25^\circ\text{C}$	5 μ A
I_{RRM} MAX @ $V_{DRM} = V_{RRM}$	$T_j = 125^\circ\text{C}$	4mA

GENERAL NOTES

1. All parameters at 25 degrees C unless otherwise specified.

Thermal Resistances

		SYMBOL	RATING
Junction to Case (AC)	TO-220AB	$R_{th(j-c)}$	1.0°C/W
Junction to Case (AC)	TO-220AB Isolated	$R_{th(j-c)}$	1.9°C/W
Junction to Ambient	TO-220AB	$R_{th(j-a)}$	60°C/W
Junction to Ambient	TO-220AB Isolated	$R_{th(j-a)}$	60°C/W

Part Number Designation

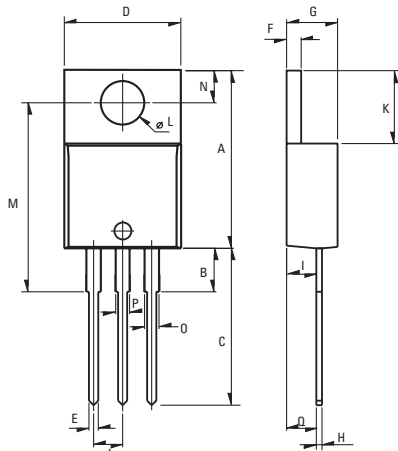

Weight: 2.3g (0.08 oz)

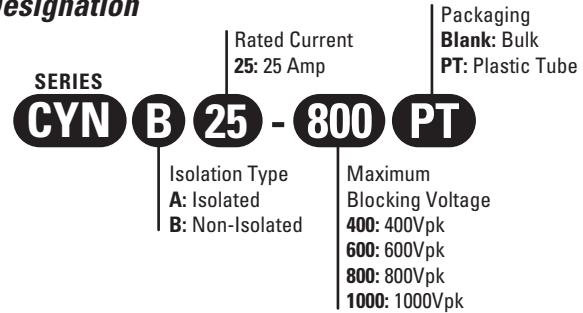

Dimensions

REF.	Millimeters			Inches		
	Min.	Typ.	Max.	Min.	Typ.	Max.
A	15.24		15.75	0.6		0.62
B		3.23			0.127	
C	12.78		13.79	0.503		0.543
D	9.96		10.36	0.392		0.408
E	0.69		0.94	0.027		0.037
F	1.22		1.32	0.048		0.052
G	4.62		4.83	0.182		0.19
H	0.46		0.61	0.018		0.024
I	2.49		2.84	0.098		0.112
J	2.39		2.69	0.094		0.106
K	6.48		6.88	0.255		0.271
L	3.78		3.89	0.149		0.153
M	15.49	16	16.51	0.61	0.63	0.65
N	2.59		2.9	0.102		0.114
O	0.99		1.55	0.039		0.061
P	0.99		1.55	0.039		0.061
Q		2.67			0.105	

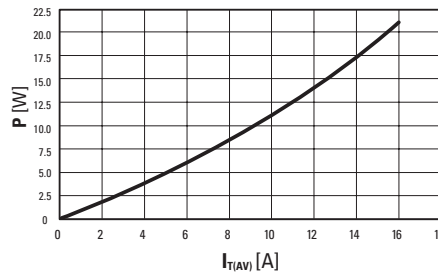

Fig. 1: Power dissipation versus average on-state current.

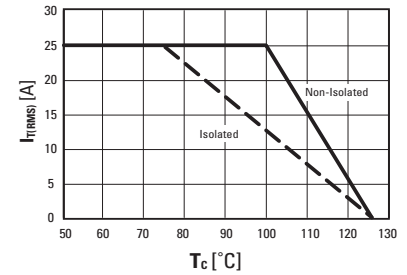

Fig. 2: RMS on-state current versus case temperature (full cycle)

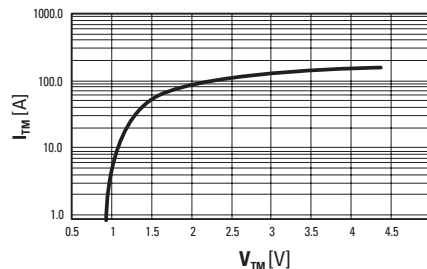

Fig. 3: On-state current versus on-state voltage (instantaneous values)

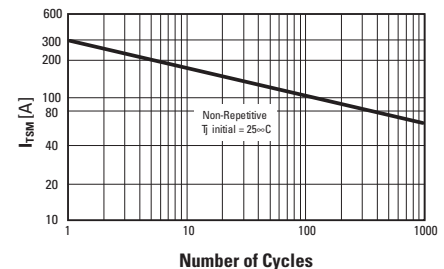

Fig. 4: Non-repetitive surge peak on-state current versus number of cycles.

ISO9001 Certified

Approvals

UL Recognized Component - E72445
(For CYNA series)

USA

Sales Support (877) 502-5500
Tech Support (877) 702-7700
Fax (619) 710-8540
Email: sales@crydom.com
Crydom Corp
2320 Paseo de las Americas, Suite 201
San Diego, CA 92154

EUROPE - UK

Telephone +44 (0) 1202 365070
Fax +44 (0) 1202 365090
Email: intsales@crydom.com
Crydom International Ltd.
7 Cobham Road
Ferndown Industrial Estate
Wimborne, Dorset BH21 7PE

Germany

Telephone +49 (0) 180 3000 506

ASIA - Thailand

Telephone +66 (0)2 665 2517
Fax +66 (0)2 665 2588
Crydom Asia
18/8 Fico Place 12th Floor
Soi Sukhumvit 21 (Asoke)
Klongtoey Nua, Wattana
Bangkok, Thailand 10110