



CTA/CTB12

12Amp - 400/600/800/1000V - TRIAC

Applications

- Phase Control
- Static Switching
- Light Dimming
- Motor Speed Control
- Kitchen Equipment
- Power Tools
- Solenoid Valve Controls:
 - Dishwashers
 - Washing Machines

- > Suitable for General Purpose AC Switching
- > Alternistor/No Snubber Versions for Inductive Loads
- > Logic Level Available for use with Microcontrollers and Low Level Devices
- > IGT Range 5-50 mA (Q1)
- > V_{DRM}/V_{RMM} 400, 600, 800, 1000V

Absolute Maximum Ratings

	CONDITIONS	SYMBOL	RATING
RMS On-State Current (full sine wave)	T _c = 105°C T _c = 90°C	T0-220AB T0-220AB Iso	I _{T(RMS)} 12A
Non Repetitive Surge Peak On-State Current (Full Cycle, T _j Initial = 25°C)	F = 50 Hz F = 60 Hz	I _{TSM}	120A 126A
I ² t Value for fusing	tp = 10 ms	I ² t	78A ² s
Critical rate of rise of on-state current I _G = 2 x I _{GT} , tr < 100ns, T _j = 125°C		di/dt	100A/μs
Peak Gate Current @ T _j = 125°C	tp = 20 μs	I _{GM}	4A
Average Gate Power Dissipation @ T _j = 125°C		P _{G(AV)}	1W
Storage Temperature Range		T _{stg}	-40 to +150°C
Operating Junction Temperature Range		T _j	-40 to +125°C
Isolation Voltage (CTA Series only)		V _{ISO}	2500 V _{RMS}

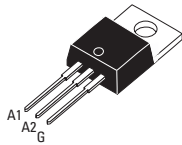

TO-220AB Isolated (CTA12)

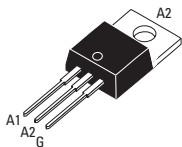

TO-220AB Non-Isolated (CTB12)



Electrical Characteristics

ALTERNISTOR/NO SNUBBER AND LOGIC LEVEL (3 Quadrants)	TW	SW	CW	BW		
I _{GT} MAX @ V _D = 12 V, R _L = 30Ω NOTE 1	QI-II-III	5mA	10mA	35mA	50mA	
V _{GT} MAX @ V _D = 12 V, R _L = 30Ω	QI-II-III	1.3V	1.3V	1.3V	1.3V	
V _{GD} MIN @ V _D = V _{DRM} , R _L = 3.3kΩ	T _j = 125°C	QI-II-III	0.2V	0.2V	0.2V	
I _H MAX @ I _T = 500 mA NOTE 2			10mA	15mA	35mA	50mA
I _L MAX @ I _G = 1.2 I _{GT}	QI-III	10mA	25mA	50mA	70mA	
I _L MAX @ I _G = 1.2 I _{GT}	Q-II	15mA	30mA	60mA	80mA	
dv/dt MIN @ V _D = 67%V _{DRM} (gate open) NOTE 2	T _j = 125°C		20V/μs	40V/μs	400V/μs	1000V/μs
(di/dt) _c MIN @ (dv/dt) _c = 0.1 V/ms NOTE 2	T _j = 125°C		3.5A/ms	5.4A/ms		
(di/dt) _c MIN @ (dv/dt) _c = 10 V/ms NOTE 2	T _j = 125°C		1A/ms	2.9A/ms		
(di/dt) _c MIN without Snubber NOTE 2	T _j = 125°C				6.5A/ms	12A/ms

STANDARD (4 Quadrants)	C	B		
I _{GT} MAX @ V _D = 12 V, R _L = 30Ω NOTE 1	QI-II-III	25mA	50mA	
I _{GT} MAX @ V _D = 12 V, R _L = 30Ω NOTE 1	QIV	50mA	100mA	
V _{GT} MAX @ V _D = 12 V, R _L = 30Ω	Q-All		1.3V	
V _{GD} MIN @ V _D = V _{DRM} , R _L = 3.3kΩ	T _j = 125°C	Q-All	0.2V	
I _H MAX @ I _T = 500 mA NOTE 2			25mA	50mA
I _L MAX @ I _G = 1.2 I _{GT}	QI-III-IV		40mA	50mA
I _L MAX @ I _G = 1.2 I _{GT}	Q-II		80mA	100mA
dv/dt MIN @ V _D = 67%V _{DRM} (gate open) NOTE 2	T _j = 125°C		200V/μs	400V/μs
(dv/dt) _c MIN @ (di/dt) _c = 2.7 A/ms NOTE 2	T _j = 125°C		5V/μs	10V/μs

GENERAL NOTES

1. Minimum IGT is guaranteed at 5% of IGT max.
2. For both polarities of A2 referenced to A1
3. All parameters at 25 degrees C unless otherwise specified.

Static Characteristics

V_T MAX @ $I_{TM}=17$ A, $t_p = 380\mu s$ NOTE 2	$T_j = 25^\circ C$	1.55V
V_{TO} MAX @ Threshold Voltage NOTE 2	$T_j = 125^\circ C$	0.85V
R_d MAX @ Dynamic Resistance NOTE 2	$T_j = 125^\circ C$	35mΩ
I_{DRM} MAX @ $V_{DRM} = V_{RRM}$	$T_j = 25^\circ C$	5μA
I_{RRM} MAX @ $V_{DRM} = V_{RRM}$	$T_j = 125^\circ C$	1mA

Thermal Resistances

	SYMBOL	RATING
Junction to Case (AC)	TO-220AB $R_{th(j-c)}$	1.4°C/W
Junction to Case (AC)	TO-220AB Isolated $R_{th(j-c)}$	2.3°C/W
Junction to Ambient	TO-220AB $R_{th(j-a)}$	60°C/W
Junction to Ambient	TO-220AB Isolated $R_{th(j-a)}$	60°C/W

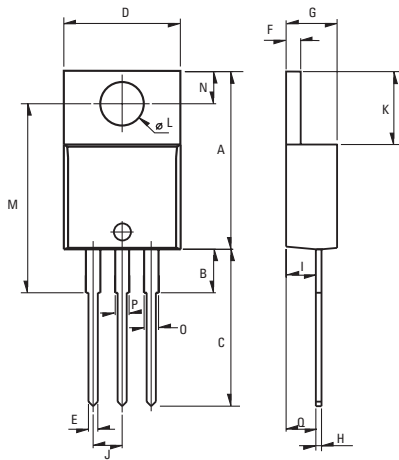

Weight: 2.3g (0.08 oz)

Dimensions

REF.	Millimeters			Inches		
	Min.	Typ.	Max.	Min.	Typ.	Max.
A	15.24		15.75	0.6		0.62
B		3.23			0.127	
C	12.78		13.79	0.503		0.543
D	9.96		10.36	0.392		0.408
E	0.69		0.94	0.027		0.037
F	1.22		1.32	0.048		0.052
G	4.62		4.83	0.182		0.19
H	0.46		0.61	0.018		0.024
I	2.49		2.84	0.098		0.112
J	2.39		2.69	0.094		0.106
K	6.48		6.88	0.255		0.271
L	3.78		3.89	0.149		0.153
M	15.49	16	16.51	0.61	0.63	0.65
N	2.59		2.9	0.102		0.114
O	0.99		1.55	0.039		0.061
P	0.99		1.55	0.039		0.061
Q		2.67			0.105	

Part Number Selection

Part Number	Voltage [Vpk]	I_{GT} [mA]	Type	Package
CTA/CTB12-xxxB	400, 600, 800, 1000	50mA	Standard	TO-220AB
CTA/CTB12-xxxBW	400, 600, 800, 1000	50mA	Alternistor/No Snubber	TO-220AB
CTA/CTB12-xxxC	400, 600, 800, 1000	25mA	Standard	TO-220AB
CTA/CTB12-xxxCW	400, 600, 800, 1000	35mA	Alternistor/No Snubber	TO-220AB
CTA/CTB12-xxxSW	400, 600, 800, 1000	10mA	Logic Level	TO-220AB
CTA/CTB12-xxxTW	400, 600, 800	5mA	Logic Level	TO-220AB

Part Number Designation

SERIES
CT **B** **12** - **800** **CW** **PT**

Rated Current
12: 12 Amp

Type
B: Standard ($I_{GT}=50$ mA)
BW: Alternistor/No Snubber ($I_{GT}=50$ mA)
C: Standard ($I_{GT}=25$ mA)
CW: Alternistor/No Snubber ($I_{GT}=35$ mA)
SW: Logic Level ($I_{GT}=10$ mA)
TW: Logic Level ($I_{GT}=5$ mA)

Maximum Blocking Voltage
400: 400Vpk
600: 600Vpk
800: 800Vpk
1000: 1000Vpk

Packaging
Blank: Bulk
PT: Plastic Tube

Isolation Type
A: Isolated
B: Non-Isolated

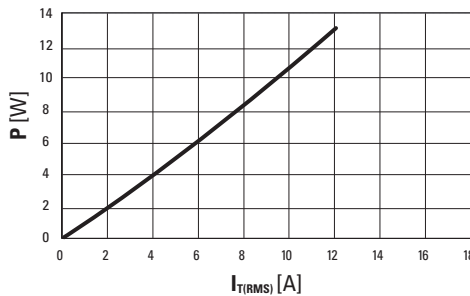

Fig. 1: Power dissipation versus RMS on-state current (full cycle).

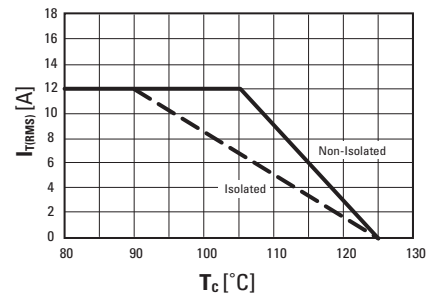

Fig. 2: RMS on-state current versus case temperature (full cycle)

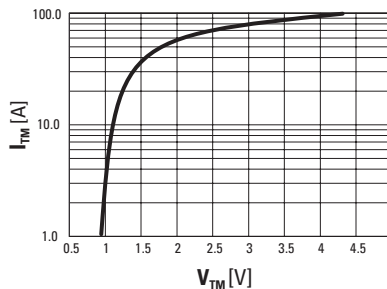

Fig. 3: On-state current versus on-state voltage (instantaneous values)

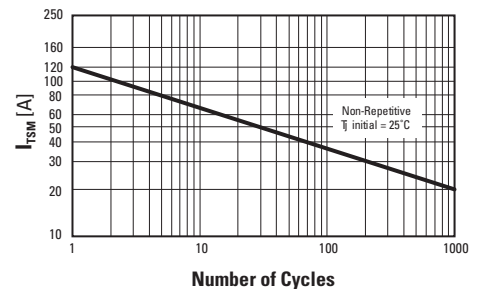

Fig. 4: Non-repetitive surge peak on-state current versus number of cycles.

ISO9001 Certified

Approvals

UL Recognized Component - E72445
(For CTA series)

USA

Sales Support (877) 502-5500
 Tech Support (877) 702-7700
 Fax (619) 710-8540
 Email: sales@crydom.com
 Crydom Corp
 2320 Paseo de las Americas, Suite 201
 San Diego, CA 92154

EUROPE - UK

Telephone +44 (0) 1202 365070
 Fax +44 (0) 1202 365090
 Email: intsales@crydom.com
 Crydom International Ltd.
 7 Cobham Road
 Ferndown Industrial Estate
 Wimborne, Dorset BH21 7PE

Germany

Telephone +49 (0) 180 3000 506

ASIA - Thailand

Telephone +66 (0)2 665 2517
 Fax +66 (0)2 665 2588
 Crydom Asia
 18/8 Fico Place 12th Floor
 Soi Sukhumvit 21 (Asoke)
 Klongtoey Nua, Wattana
 Bangkok, Thailand 10110