

**SCR/Diode
POW-R-BLOK™ Modules
90 Amperes/1200-1600 Volts**

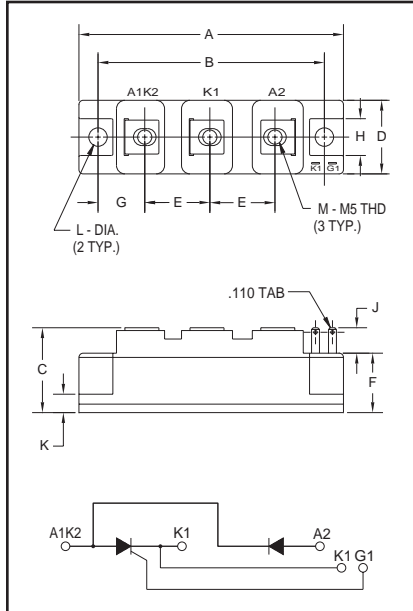

Outline Drawing

Dimension	Inches	Millimeters
A	3.681 Max.	93.5 Max.
B	3.150	80
C	1.181 Max.	30 Max.
D	1.024 Max.	26 Max.
E	0.906	23
F	0.827	21
G	0.650	16.5
H	0.512	13
J	0.354	9
K	0.256	6.5
L	0.256 Dia.	Dia. 6.5
M	M5 Metric	M5



**CM421290, CM421690
SCR/Diode
POW-R-BLOK™ Modules
90 Amperes/1200-1600 Volts**

Description:

Powerex SCR/Diode POW-R-BLOK™ Modules are designed for use in applications requiring Half-Control and isolated packaging. The modules are isolated for easy mounting with other components on common heatsinks.

Features:

- Isolated Mounting
- Glass Passivated Chips
- Metal Baseplate
- Low Thermal Impedance

Applications:

- Battery Supplies
- Bridge Circuits
- AC and DC Motor Control
- Tap Changers
- Lighting Control

Ordering Information:

Select the complete eight digit module part number you desire from the table below. Example: CM421290 is a 1200 Volt, 90 Ampere SCR/Diode POW-R-BLOK™ Module.

Type	Voltage Volts (x100)	Current Rating Amperes (90)
CM42	12 16	90



Powerex, Inc., 200 Hillis Street, Youngwood, Pennsylvania 15697-1800 (724) 925-7272

CM421290, CM421690
SCR/Diode POW-R-BLOK™ Modules
90 Amperes/1200-1600 Volts

Absolute Maximum Ratings

Characteristics	Symbol	CM421290	CM421690	Units
Peak Forward Blocking Voltage	V_{DRM}	1200	1600	Volts
Transient Peak Forward Blocking Voltage (Non-Repetitive), $t < 5\text{ms}$	V_{DSM}	1350	1700	Volts
DC Forward Blocking Voltage	$V_{D(DC)}$	960	1280	Volts
Peak Reverse Blocking Voltage	V_{RRM}	1200	1600	Volts
Transient Peak Reverse Blocking Voltage (Non-Repetitive), $t < 5\text{ms}$	V_{RSM}	1350	1700	Volts
DC Reverse Blocking Voltage	$V_{R(DC)}$	960	1280	Volts
RMS On-State Current	$I_T(\text{RMS}), I_F(\text{RMS})$	140	140	Amperes
Average On-State Current, $T_C = 82^\circ\text{C}$	$I_T(\text{AV}), I_F(\text{AV})$	90	90	Amperes
Peak One-Cycle Surge (Non-Repetitive) On-State Current (60Hz)	I_{TSM}, I_{FSM}	1800	1800	Amperes
Peak One-Cycle Surge (Non-Repetitive) On-State Current (50Hz)	I_{TSM}, I_{FSM}	1730	1730	Amperes
I^2t (for Fusing), 8.3 milliseconds	I^2t	15000	15000	A^2sec
Critical Rate-of-Rise of On-State Current*	di/dt	100	100	Amperes/ μs
Peak Gate Power Dissipation	P_{GM}	5.0	5.0	Watts
Average Gate Power Dissipation	$P_{G(\text{AV})}$	0.5	0.5	Watts
Peak Forward Gate Voltage	V_{GFM}	10	10	Volts
Peak Reverse Gate Voltage	V_{GRM}	5.0	5.0	Volts
Peak Forward Gate Current	I_{GFM}	2.0	2.0	Amperes
Storage Temperature	T_{STG}	-40 to 125	-40 to 125	$^\circ\text{C}$
Operating Temperature	T_j	-40 to 125	-40 to 125	$^\circ\text{C}$
Maximum Mounting Torque M6 Mounting Screw	—	26	26	in.-lb.
Maximum Mounting Torque M5 Terminal Screw	—	17	17	in.-lb.
Module Weight (Typical)	—	160	160	Grams
V Isolation	V_{RMS}	2500	2500	Volts

* $T_j = 125^\circ\text{C}$, $I_G = 1.0\text{A}$, $V_D = 1/2 V_{DRM}$

Electrical and Thermal Characteristics, $T_j = 25^\circ\text{C}$ unless otherwise specified

Characteristics	Symbol	Test Conditions	CM421290/CM421690	Units
Blocking State Maximums				
Forward Leakage Current, Peak	I_{DRM}	$T_j = 125^\circ\text{C}$, $V_{DRM} = \text{Rated}$	15	mA
Reverse Leakage Current, Peak	I_{RRM}	$T_j = 125^\circ\text{C}$, $V_{RRM} = \text{Rated}$	15	mA
Conducting State Maximums				
Peak On-State Voltage	V_{FM}, V_{TM}	$I_{FM} = 270\text{A}$, $I_{TM} = 270\text{A}$	1.4	Volts
Switching Minimums				
Critical Rate-of-Rise of Off-State Voltage	dv/dt	$T_j = 125^\circ\text{C}$, $V_D = 2/3 V_{DRM}$	500	Volts/ μs
Thermal Maximums				
Thermal Resistance, Junction-to-Case	$R_{\theta(J-C)}$	Per Module	0.3	$^\circ\text{C}/\text{Watt}$
Thermal Resistance, Case-to-Sink (Lubricated)	$R_{\theta(C-S)}$	Per Module	0.2	$^\circ\text{C}/\text{Watt}$
Gate Parameters Maximums				
Gate Current-to-Trigger	I_{GT}	$V_D = 6\text{V}$, $R_L = 2\Omega$	100	mA
Gate Voltage-to-Trigger	V_{GT}	$V_D = 6\text{V}$, $R_L = 2\Omega$	2.0	Volts
Non-Triggering Gate Voltage	V_{GDM}	$T_j = 125^\circ\text{C}$, $V_D = 1/2 V_{DRM}$	0.25	Volts

CM421290, CM421690
SCR/Diode POW-R-BLOK™ Modules
 90 Amperes/1200-1600 Volts

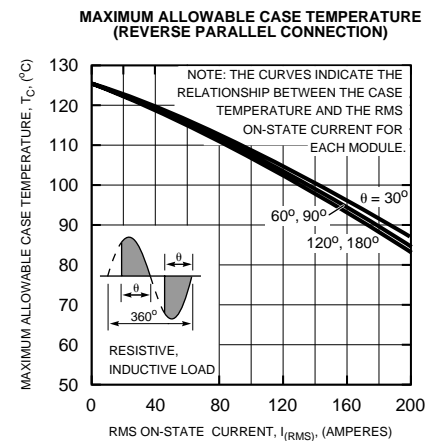
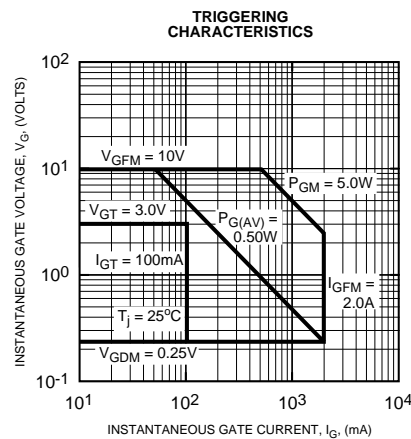
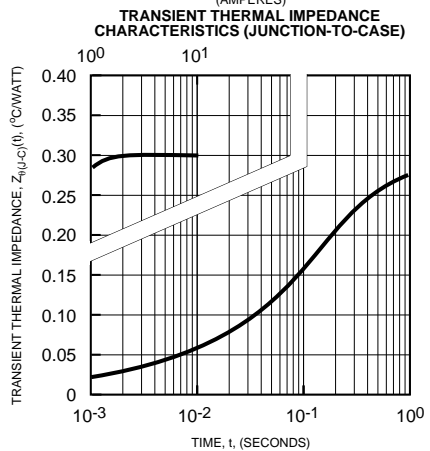
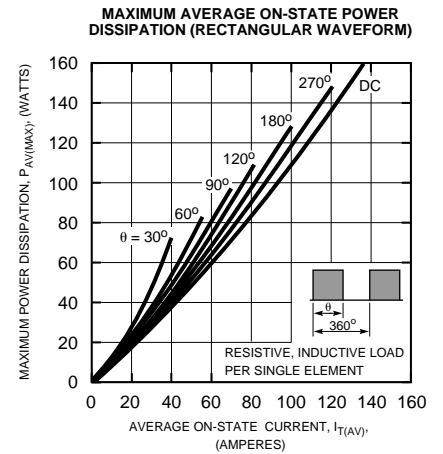
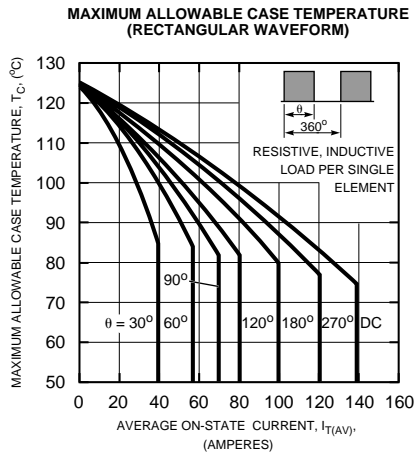
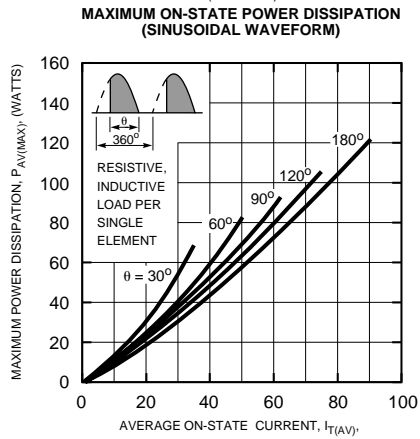
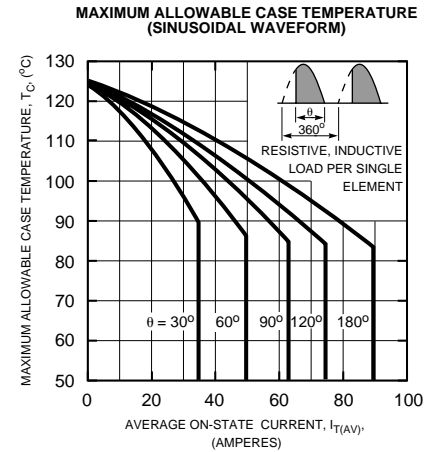
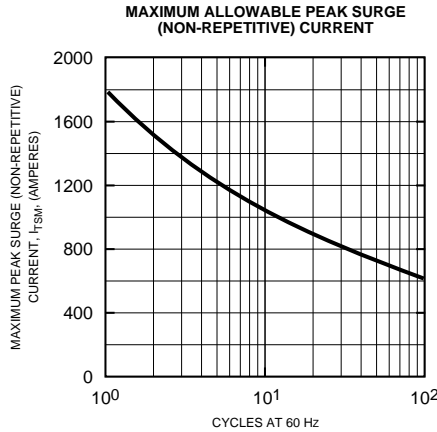
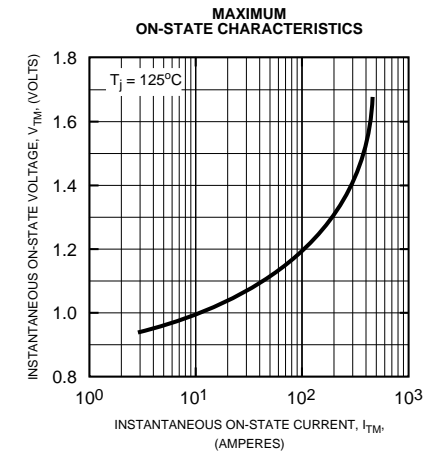

CM421290, CM421690
SCR/Diode POW-R-BLOK™ Modules
 90 Amperes/1200-1600 Volts

MAXIMUM ON-STATE POWER DISSIPATION (REVERSE PARALLEL CONNECTION)

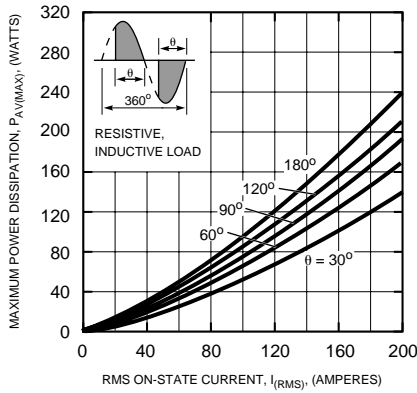

NOTE: THE CURVES INDICATE THE RELATIONSHIP BETWEEN THE AVERAGE ON-STATE POWER DISSIPATION PER MODULE AND THE RMS ON-STATE CURRENT.

MAXIMUM ALLOWABLE CASE TEMPERATURE (SINGLE PHASE BRIDGE CONNECTION)

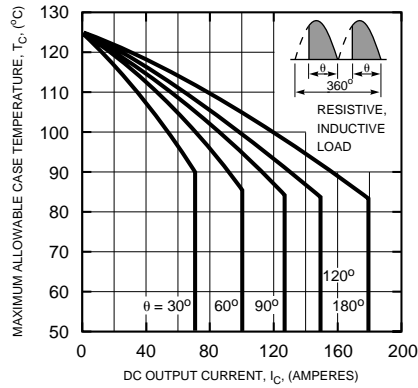

NOTE: THE CURVES INDICATE THE RELATIONSHIP BETWEEN THE CASE TEMPERATURE AND THE DC OUTPUT CURRENT (FOR TWO ELEMENTS) WHEN USED IN THE SINGLE PHASE BRIDGE CONFIGURATION.

MAXIMUM ON-STATE POWER DISSIPATION (SINGLE PHASE BRIDGE CONNECTION)

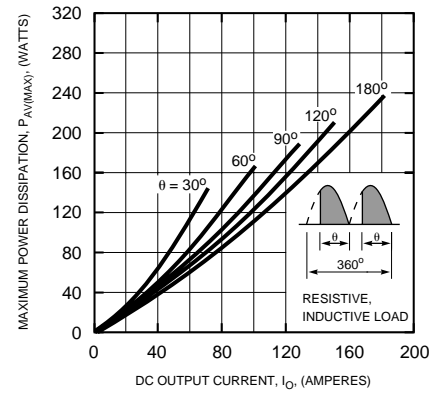

NOTE: THE CURVES INDICATE THE RELATIONSHIP BETWEEN THE AVERAGE ON-STATE POWER DISSIPATION AND THE DC OUTPUT CURRENT FOR THE SINGLE PHASE BRIDGE CONFIGURATION (POWER DISSIPATION EXPRESSED FOR EACH MODULE AND DC OUTPUT CURRENT EXPRESSED FOR THE PAIR)

MAXIMUM ALLOWABLE CASE TEMPERATURE (THREE PHASE BRIDGE CONNECTION)

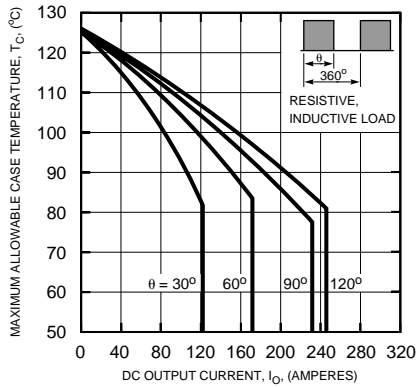

NOTE: THE CURVES INDICATE THE RELATIONSHIP BETWEEN THE CASE TEMPERATURE AND THE DC OUTPUT CURRENT (FOR THREE MODULES) IN THE THREE PHASE CONFIGURATION.

MAXIMUM ON-STATE POWER DISSIPATION (THREE PHASE BRIDGE CONNECTION)

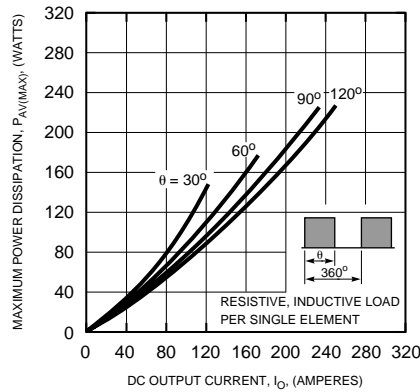

NOTE: THE CURVES INDICATE THE RELATIONSHIP BETWEEN THE ON-STATE POWER DISSIPATION (PER MODULE) AND THE DC OUTPUT CURRENT (FOR THREE MODULES) IN THE THREE PHASE BRIDGE CONFIGURATION.