

# MITSUBISHI IGBT MODULES

## CM400HU-24H

HIGH POWER SWITCHING USE  
INSULATED TYPE

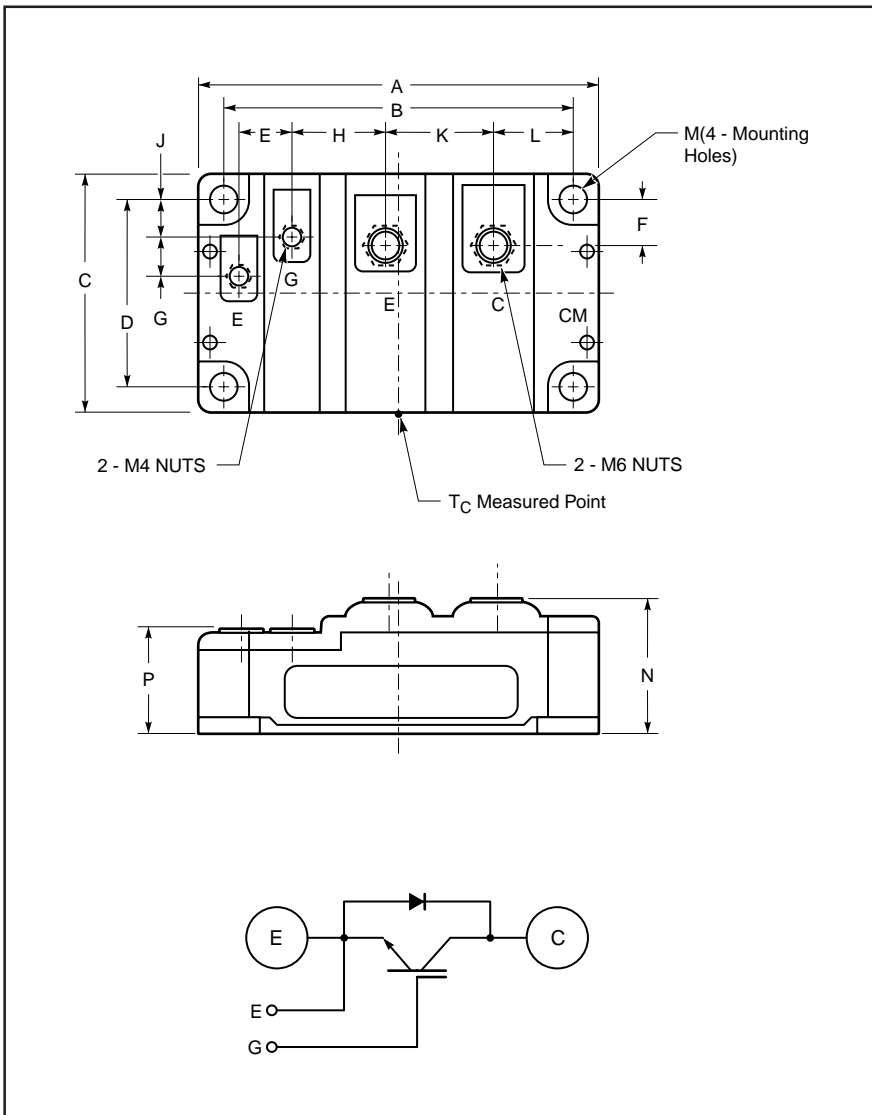

Outline Drawing and Circuit Diagram

Dimensions	Inches	Millimeters
A	4.21	107.0
B	3.66±0.01	93.0±0.25
C	2.44	62.0
D	1.89±0.01	48.0±0.25
E	0.53	13.5
F	0.37	9.5
G	0.45	11.5

Dimensions	Inches	Millimeters
H	0.96	24.5
J	0.31	8.0
K	1.14	29.0
L	0.81	20.5
M	0.26 Dia.	6.5 Dia.
N	1.34 +0.04/-0.02	34 +1.0/-0.5
P	1.02 +0.04/-0.02	26 +1.0/-0.5



### Description:

Mitsubishi IGBT Modules are designed for use in switching applications. Each module consists of one IGBT in a single configuration with a reverse-connected super-fast recovery free-wheel diode. All components and interconnects are isolated from the heat sinking baseplate, offering simplified system assembly and thermal management.

### Features:

- Low Drive Power
- Low  $V_{CE(sat)}$
- Discrete Super-Fast Recovery Free-Wheel Diode
- High Frequency Operation
- Isolated Baseplate for Easy Heat Sinking

### Applications:

- AC Motor Control
- Motion/Servo Control
- UPS
- Welding Power Supplies

### Ordering Information:

Example: Select the complete module number you desire from the table - i.e. CM400HU-24H is a 1200V ( $V_{CES}$ ), 400 Ampere Single IGBT Module.

Type	Current Rating Amperes	$V_{CES}$ Volts (x 50)
CM	400	24

## CM400HU-24H

HIGH POWER SWITCHING USE  
INSULATED TYPEAbsolute Maximum Ratings,  $T_j = 25\text{ }^\circ\text{C}$  unless otherwise specified

	Symbol	Ratings	Units
Junction Temperature	$T_j$	-40 to 150	$^\circ\text{C}$
Storage Temperature	$T_{stg}$	-40 to 125	$^\circ\text{C}$
Collector-Emitter Voltage (G-E SHORT)	$V_{CES}$	1200	Volts
Gate-Emitter Voltage (C-E SHORT)	$V_{GES}$	$\pm 20$	Volts
Collector Current ( $T_c = 25^\circ\text{C}$ )	$I_C$	400	Amperes
Peak Collector Current ( $T_j \leq 150^\circ\text{C}$ )	$I_{CM}$	800*	Amperes
Emitter Current** ( $T_c = 25^\circ\text{C}$ )	$I_E$	400	Amperes
Peak Emitter Current**	$I_{EM}$	800*	Amperes
Maximum Collector Dissipation ( $T_c = 25^\circ\text{C}$ )	$P_C$	2100	Watts
Mounting Torque, M6 Main Terminal, M6 Mounting	–	3.5~4.5	N · m
Mounting Torque, M4 Terminal	–	1.3~1.7	N · m
Weight	–	450	Grams
Isolation Voltage (Main Terminal to Baseplate, AC 1 min.)	$V_{iso}$	2500	Vrms

\* Pulse width and repetition rate should be such that the device junction temperature ( $T_j$ ) does not exceed  $T_{j(max)}$  rating.

\*\*Represents characteristics of the anti-parallel, emitter-to-collector free-wheel diode (FWDi).

Static Electrical Characteristics,  $T_j = 25\text{ }^\circ\text{C}$  unless otherwise specified

Characteristics	Symbol	Test Conditions	Min.	Typ.	Max.	Units
Collector-Cutoff Current	$I_{CES}$	$V_{CE} = V_{CES}, V_{GE} = 0V$	–	–	2	mA
Gate Leakage Voltage	$I_{GES}$	$V_{GE} = V_{GES}, V_{CE} = 0V$	–	–	0.5	$\mu\text{A}$
Gate-Emitter Threshold Voltage	$V_{GE(th)}$	$I_C = 40\text{mA}, V_{CE} = 10V$	4.5	6	7.5	Volts
Collector-Emitter Saturation Voltage	$V_{CE(sat)}$	$I_C = 400\text{A}, V_{GE} = 15V, T_j = 25^\circ\text{C}$	–	2.9	3.7	Volts
		$I_C = 400\text{A}, V_{GE} = 15V, T_j = 125^\circ\text{C}$	–	2.85	–	Volts
Total Gate Charge	$Q_G$	$V_{CC} = 600V, I_C = 400\text{A}, V_{GE} = 15V$	–	1500	–	nC
Emitter-Collector Voltage*	$V_{EC}$	$I_E = 400\text{A}, V_{GE} = 0V$	–	–	3.2	Volts

\* Pulse width and repetition rate should be such that the device junction temperature ( $T_j$ ) does not exceed  $T_{j(max)}$  rating.Dynamic Electrical Characteristics,  $T_j = 25\text{ }^\circ\text{C}$  unless otherwise specified

Characteristics	Symbol	Test Conditions	Min.	Typ.	Max.	Units	
Input Capacitance	$C_{ies}$		–	–	60	nF	
Output Capacitance	$C_{oes}$	$V_{CE} = 10V, V_{GE} = 0V$	–	–	21	nF	
Reverse Transfer Capacitance	$C_{res}$		–	–	12	nF	
Resistive	Turn-on Delay Time	$t_{d(on)}$	$V_{CC} = 600V, I_C = 400\text{A},$	–	–	250	ns
Load	Rise Time	$t_r$	$V_{GE1} = V_{GE2} = 15V,$	–	–	350	ns
Switch	Turn-off Delay Time	$t_{d(off)}$	$R_G = 0.78\Omega, \text{Resistive}$	–	–	350	ns
Times	Fall Time	$t_f$	Load Switching Operation	–	–	350	ns
Diode Reverse Recovery Time	$t_{rr}$	$I_E = 400\text{A}, di_E/dt = -800\text{A}/\mu\text{s}$	–	–	300	ns	
Diode Reverse Recovery Charge	$Q_{rr}$	$I_E = 400\text{A}, di_E/dt = -800\text{A}/\mu\text{s}$	–	2.2	–	$\mu\text{C}$	

Thermal and Mechanical Characteristics,  $T_j = 25\text{ }^\circ\text{C}$  unless otherwise specified

Characteristics	Symbol	Test Conditions	Min.	Typ.	Max.	Units
Thermal Resistance, Junction to Case	$R_{th(j-c)Q}$	Per IGBT Module	–	–	0.06	$^\circ\text{C}/\text{W}$
Thermal Resistance, Junction to Case	$R_{th(j-c)D}$	Per FWDi Module	–	–	0.09	$^\circ\text{C}/\text{W}$
Contact Thermal Resistance	$R_{th(c-f)}$	Per Module, Thermal Grease Applied	–	0.02	–	$^\circ\text{C}/\text{W}$

# CM400HU-24H

HIGH POWER SWITCHING USE  
INSULATED TYPE

OUTPUT CHARACTERISTICS  
(TYPICAL)

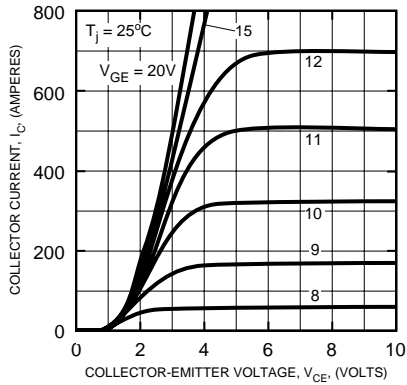

TRANSFER CHARACTERISTICS  
(TYPICAL)

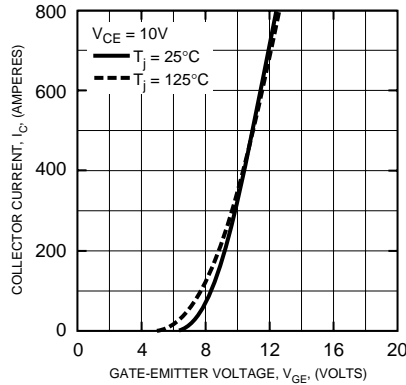

COLLECTOR-EMITTER  
SATURATION VOLTAGE CHARACTERISTICS  
(TYPICAL)

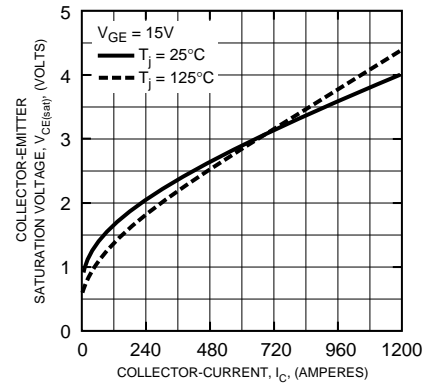

COLLECTOR-EMITTER  
SATURATION VOLTAGE CHARACTERISTICS  
(TYPICAL)

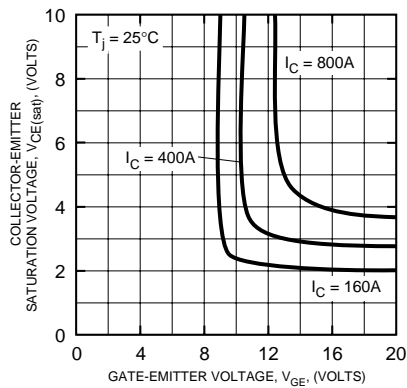

FREE-WHEEL DIODE  
FORWARD CHARACTERISTICS  
(TYPICAL)

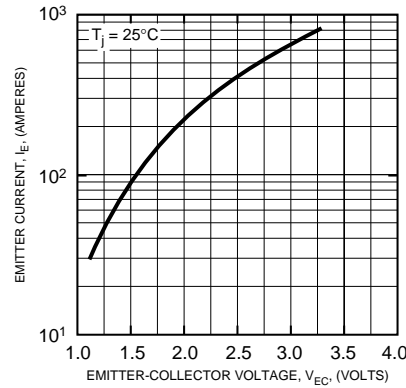

CAPACITANCE VS.  $V_{CE}$   
(TYPICAL)

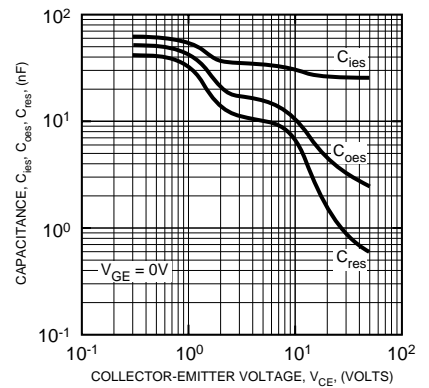

HALF-BRIDGE  
SWITCHING CHARACTERISTICS  
(TYPICAL)

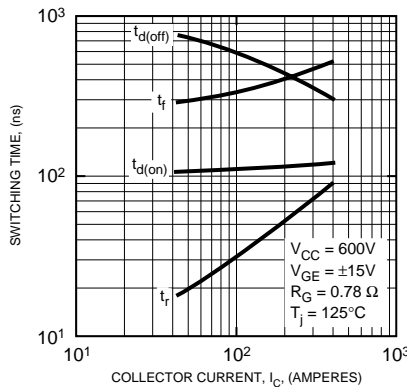

REVERSE RECOVERY CHARACTERISTICS  
(TYPICAL)

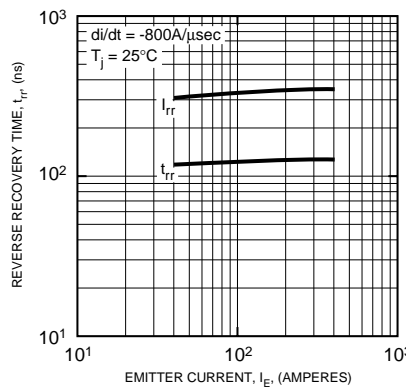

GATE CHARGE,  $V_{GE}$

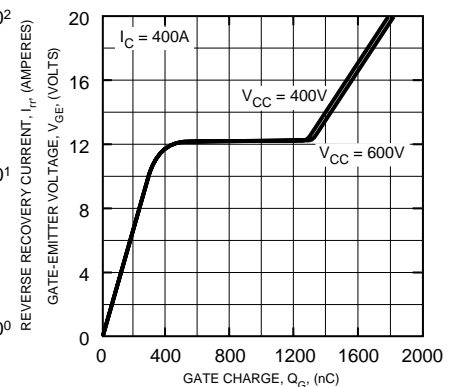

# CM400HU-24H

HIGH POWER SWITCHING USE  
INSULATED TYPE

