

Technische Information / Technical Information

IGBT-Module
IGBT-Modules

BSM15GD120DLC E3224

eupec



Höchstzulässige Werte / Maximum rated values

Elektrische Eigenschaften / Electrical properties

Kollektor-Emitter-Sperrspannung collector-emitter voltage		V_{CES}	1200	V
Kollektor-Dauergleichstrom DC-collector current	$T_C = 80^\circ\text{C}$	$I_{C,nom.}$	15	A
	$T_C = 25^\circ\text{C}$	I_C	35	A
Periodischer Kollektor Spitzenstrom repetitive peak collector current	$t_P = 1\text{ ms}, T_C = 80^\circ\text{C}$	I_{CRM}	30	A
Gesamt-Verlustleistung total power dissipation	$T_C=25^\circ\text{C}$, Transistor	P_{tot}	145	W
Gate-Emitter-Spitzenspannung gate-emitter peak voltage		V_{GES}	+/- 20V	V
Dauergleichstrom DC forward current		I_F	15	A
Periodischer Spitzenstrom repetitive peak forw. current	$t_P = 1\text{ ms}$	I_{FRM}	30	A
Grenzlastintegral der Diode I^2t - value, Diode	$V_R = 0V, t_p = 10\text{ms}, T_{vj} = 125^\circ\text{C}$	I^2t	93	A^2s
Isolations-Prüfspannung insulation test voltage	RMS, $f = 50\text{ Hz}, t = 1\text{ min.}$	V_{ISOL}	2,5	kV

Charakteristische Werte / Characteristic values

Transistor / Transistor

			min.	typ.	max.	
Kollektor-Emitter Sättigungsspannung collector-emitter saturation voltage	$I_C = 15A, V_{GE} = 15V, T_{vj} = 25^\circ\text{C}$	$V_{CE\text{ sat}}$	-	2,1	2,6	V
	$I_C = 15A, V_{GE} = 15V, T_{vj} = 125^\circ\text{C}$		-	2,4	2,9	V
Gate-Schwellenspannung gate threshold voltage	$I_C = 0,6\text{mA}, V_{CE} = V_{GE}, T_{vj} = 25^\circ\text{C}$	$V_{GE(th)}$	4,5	5,5	6,5	V
Gateladung gate charge	$V_{GE} = -15V...+15V$	Q_G	-	0,16	-	μC
Eingangskapazität input capacitance	$f = 1\text{MHz}, T_{vj} = 25^\circ\text{C}, V_{CE} = 25V, V_{GE} = 0V$	C_{ies}	-	1	-	nF
Rückwirkungskapazität reverse transfer capacitance	$f = 1\text{MHz}, T_{vj} = 25^\circ\text{C}, V_{CE} = 25V, V_{GE} = 0V$	C_{res}	-	0,07	-	nF
Kollektor-Emitter Reststrom collector-emitter cut-off current	$V_{CE} = 1200V, V_{GE} = 0V, T_{vj} = 25^\circ\text{C}$	I_{CES}	-	2	76	μA
	$V_{CE} = 1200V, V_{GE} = 0V, T_{vj} = 125^\circ\text{C}$		-	200	-	μA
Gate-Emitter Reststrom gate-emitter leakage current	$V_{CE} = 0V, V_{GE} = 20V, T_{vj} = 25^\circ\text{C}$	I_{GES}	-	-	400	nA

prepared by: Mark Münzer

date of publication: 09.09.1999

approved by: M. Hierholzer

revision: 2

Technische Information / Technical Information

IGBT-Module
IGBT-Modules

BSM15GD120DLC E3224

eupec

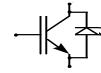

Charakteristische Werte / Characteristic values

Transistor / Transistor

			min.	typ.	max.	
Einschaltverzögerungszeit (ind. Last) turn on delay time (inductive load)	$I_C = 15A, V_{CC} = 600V$	$t_{d,on}$	-	0,07	-	μs
	$V_{GE} = \pm 15V, R_G = 56\Omega, T_{vj} = 25^\circ C$					
	$V_{GE} = \pm 15V, R_G = 56\Omega, T_{vj} = 125^\circ C$					
Anstiegszeit (induktive Last) rise time (inductive load)	$I_C = 15A, V_{CC} = 600V$	t_r	-	0,05	-	μs
	$V_{GE} = \pm 15V, R_G = 56\Omega, T_{vj} = 25^\circ C$					
	$V_{GE} = \pm 15V, R_G = 56\Omega, T_{vj} = 125^\circ C$					
Abschaltverzögerungszeit (ind. Last) turn off delay time (inductive load)	$I_C = 15A, V_{CC} = 600V$	$t_{d,off}$	-	0,3	-	μs
	$V_{GE} = \pm 15V, R_G = 56\Omega, T_{vj} = 25^\circ C$					
	$V_{GE} = \pm 15V, R_G = 56\Omega, T_{vj} = 125^\circ C$					
Fallzeit (induktive Last) fall time (inductive load)	$I_C = 15A, V_{CC} = 600V$	t_f	-	0,03	-	μs
	$V_{GE} = \pm 15V, R_G = 56\Omega, T_{vj} = 25^\circ C$					
	$V_{GE} = \pm 15V, R_G = 56\Omega, T_{vj} = 125^\circ C$					
Einschaltverlustenergie pro Puls turn-on energy loss per pulse	$I_C = 15A, V_{CC} = 600V, V_{GE} = 15V$ $R_G = 56\Omega, T_{vj} = 125^\circ C, L_S = 140nH$	E_{on}	-	2	-	mWs
Abschaltverlustenergie pro Puls turn-off energy loss per pulse	$I_C = 15A, V_{CC} = 600V, V_{GE} = 15V$ $R_G = 56\Omega, T_{vj} = 125^\circ C, L_S = 140nH$	E_{off}	-	1,5	-	mWs
Kurzschlußverhalten SC Data	$t_p \leq 10\mu sec, V_{GE} \leq 15V, R_G = 56\Omega$ $T_{vj} \leq 125^\circ C, V_{CC} = 900V, V_{CEmax} = V_{CES} - L_{sCE} \cdot di/dt$	I_{SC}	-	130	-	A
Modulinduktivität stray inductance module		L_{sCE}	-	60	-	nH
Modul Leitungswiderstand, Anschlüsse – Chip module lead resistance, terminals – chip	$T_C = 25^\circ C$	R_{CC+EE}	-	5,9	-	m Ω

Charakteristische Werte / Characteristic values

Diode / Diode

			min.	typ.	max.	
Durchlaßspannung forward voltage	$I_F = 15A, V_{GE} = 0V, T_{vj} = 25^\circ C$	V_F	-	1,8	2,3	V
	$I_F = 15A, V_{GE} = 0V, T_{vj} = 125^\circ C$					
Rückstromspitze peak reverse recovery current	$I_F = 15A, -di_F/dt = 380A/\mu sec$	I_{RM}	-	14	-	A
	$V_R = 600V, V_{GE} = -15V, T_{vj} = 25^\circ C$					
	$V_R = 600V, V_{GE} = -15V, T_{vj} = 125^\circ C$					
Sperrverzögerungsladung recovered charge	$I_F = 15A, -di_F/dt = 380A/\mu sec$	Q_r	-	1,5	-	μAs
	$V_R = 600V, V_{GE} = -15V, T_{vj} = 25^\circ C$					
	$V_R = 600V, V_{GE} = -15V, T_{vj} = 125^\circ C$					
Abschaltenergie pro Puls reverse recovery energy	$I_F = 15A, -di_F/dt = 380A/\mu sec$	E_{rec}	-	0,6	-	mWs
	$V_R = 600V, V_{GE} = -15V, T_{vj} = 25^\circ C$					
	$V_R = 600V, V_{GE} = -15V, T_{vj} = 125^\circ C$					

Technische Information / Technical Information

IGBT-Module
IGBT-Modules

BSM15GD120DLC E3224

eupec



Thermische Eigenschaften / Thermal properties

			min.	typ.	max.	
Innerer Wärmewiderstand thermal resistance, junction to case	Transistor / transistor, DC	R_{thJC}	-	-	0,86	K/W
	Diode/Diode, DC		-	-	1,50	K/W
Übergangs-Wärmewiderstand thermal resistance, case to heatsink	pro Modul / per module $\lambda_{Paste} = 1 \text{ W/m} \cdot \text{K} / \lambda_{grease} = 1 \text{ W/m} \cdot \text{K}$	R_{thCK}	-	0,02	-	K/W
Höchstzulässige Sperrschichttemperatur maximum junction temperature		T_{vj}	-	-	150	°C
Betriebstemperatur operation temperature		T_{op}	-40	-	125	°C
Lagertemperatur storage temperature		T_{stg}	-40	-	150	°C

Mechanische Eigenschaften / Mechanical properties

Gehäuse, siehe Anlage case, see appendix					
Innere Isolation internal insulation				AL ₂ O ₃	
CTI comperative tracking index				225	
Anzugsdrehmoment f. mech. Befestigung mounting torque	terminals M5	M1	3	6	Nm
Anzugsdrehmoment f. elektr. Anschlüsse terminal connection torque		M2			Nm
Gewicht weight		G		180	g

Mit dieser technischen Information werden Halbleiterbauelemente spezifiziert, jedoch keine Eigenschaften zugesichert. Sie gilt in Verbindung mit den zugehörigen Technischen Erläuterungen.

This technical information specifies semiconductor devices but promises no characteristics. It is valid in combination with the belonging technical notes.

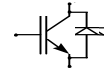

Ausgangskennlinie (typisch)
Output characteristic (typical)

$I_c = f(V_{CE})$
 $V_{GE} = 15V$

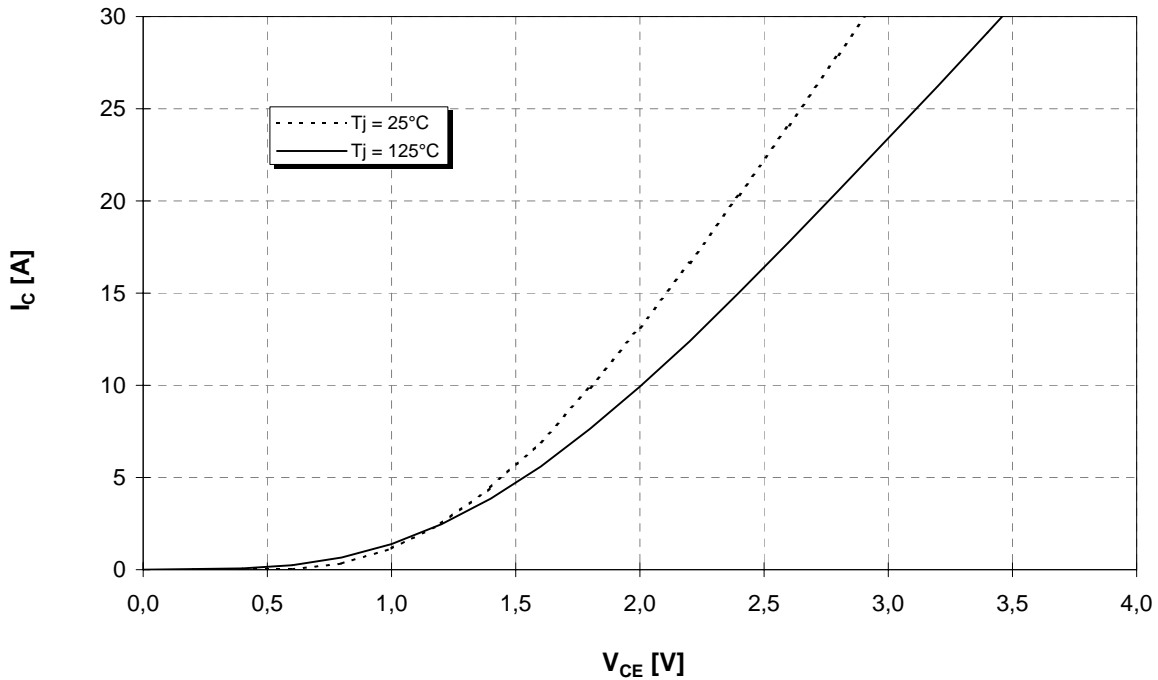

Ausgangskennlinienfeld (typisch)
Output characteristic (typical)

$I_c = f(V_{CE})$
 $T_{vj} = 125°C$

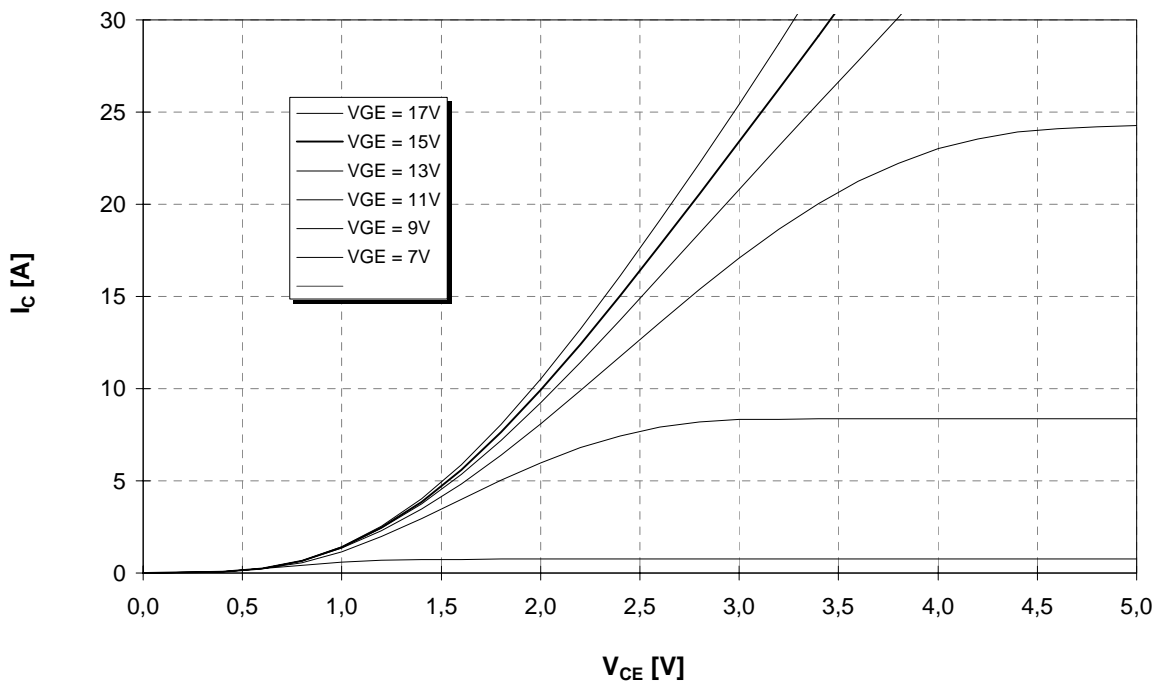

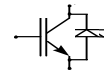

Übertragungscharakteristik (typisch)
Transfer characteristic (typical)

$I_c = f(V_{GE})$
 $V_{CE} = 20V$

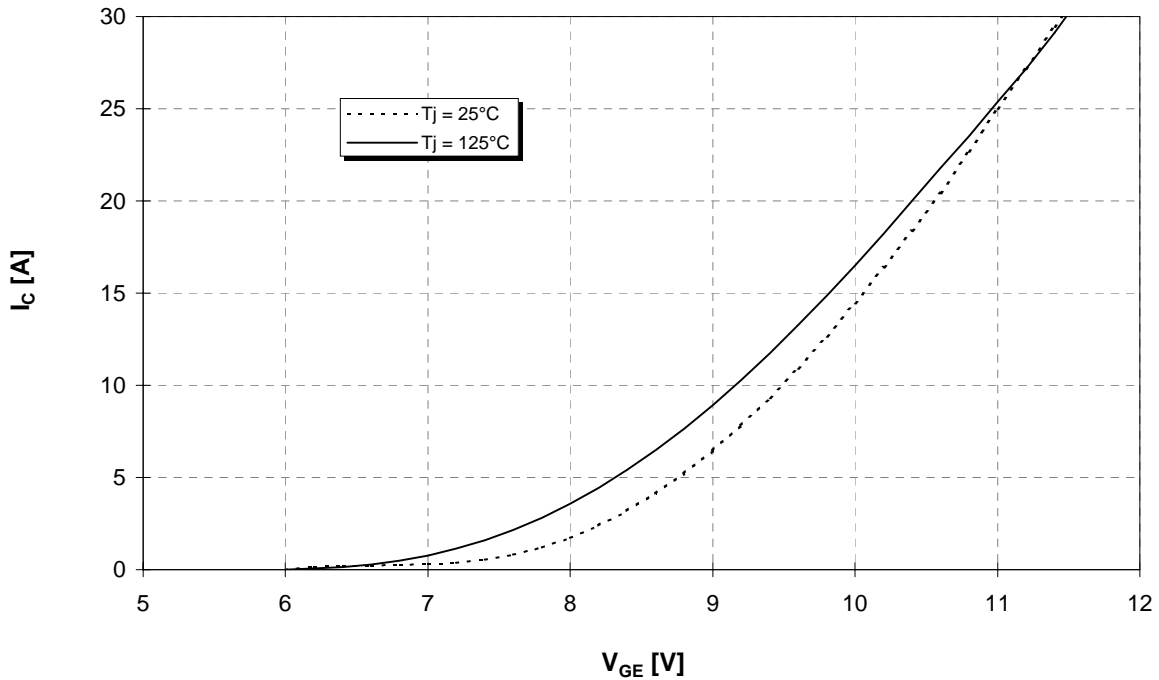

Durchlaßkennlinie der Inversdiode (typisch)
Forward characteristic of inverse diode (typical)

$I_F = f(V_F)$

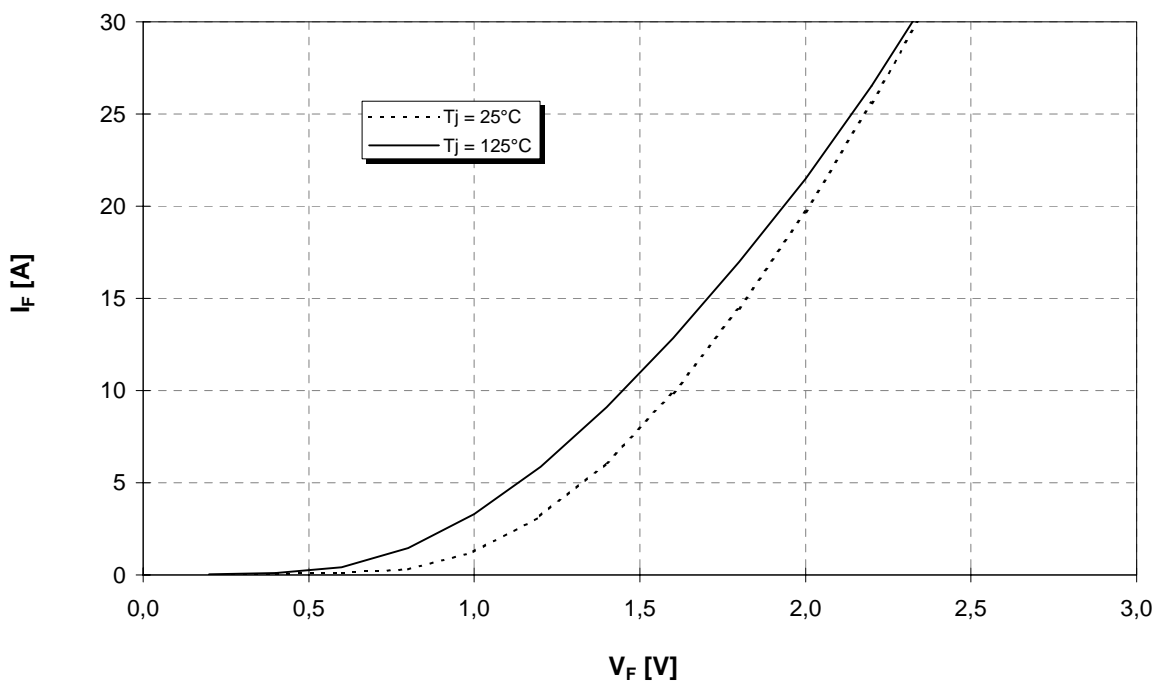

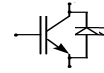

Schaltverluste (typisch) $E_{on} = f(I_C)$, $E_{off} = f(I_C)$, $E_{rec} = f(I_C)$

Switching losses (typical) $V_{GE}=15V$, $R_{gon} = R_{goff} = 56 \Omega$, $V_{CE} = 600V$, $T_J = 125^\circ C$

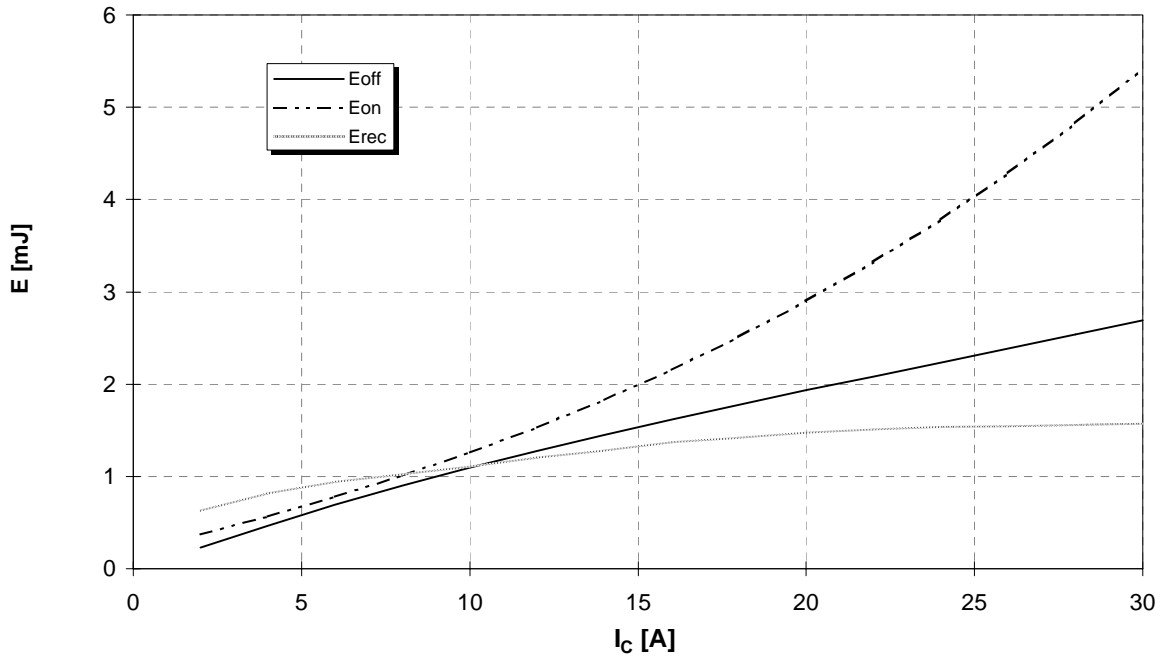

Schaltverluste (typisch)

$E_{on} = f(R_G)$, $E_{off} = f(R_G)$, $E_{rec} = f(R_G)$

Switching losses (typical)

$V_{GE}=15V$, $I_C = 15A$, $V_{CE} = 600V$, $T_J = 125^\circ C$

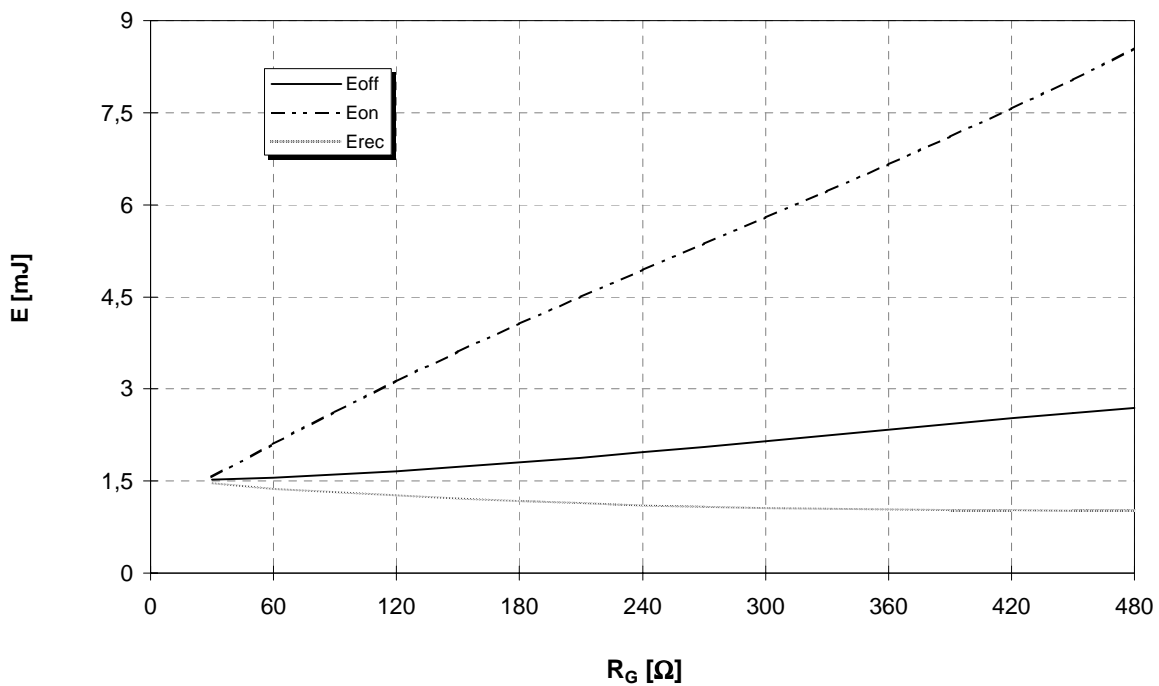

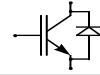

**Transienter Wärmewiderstand
Transient thermal impedance**

$Z_{thJC} = f(t)$

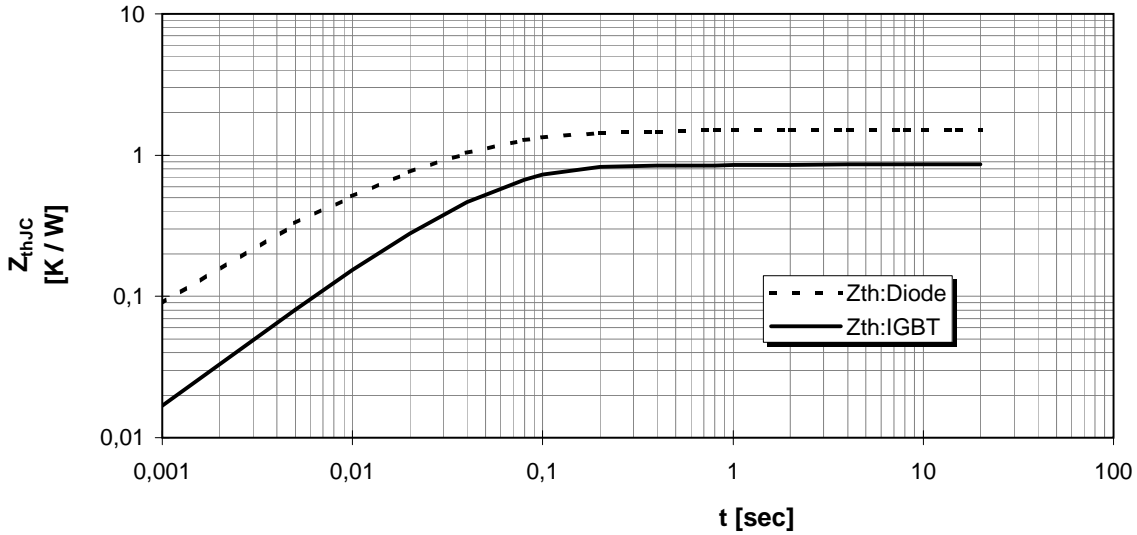

i	1	2	3	4
r_i [K/kW] : IGBT	388	326,8	118,7	26,5
τ_i [sec] : IGBT	0,048	0,049	0,055	1,149
r_i [K/kW] : Diode	164,3	438,7	778,6	118,4
τ_i [sec] : Diode	0,003	0,018	0,043	0,312

Sicherer Arbeitsbereich (RBSOA)

Reverse bias safe operation area (RBSOA)

$V_{GE} = 15V, R_g = 56 \text{ Ohm}, T_v = 125^\circ C$

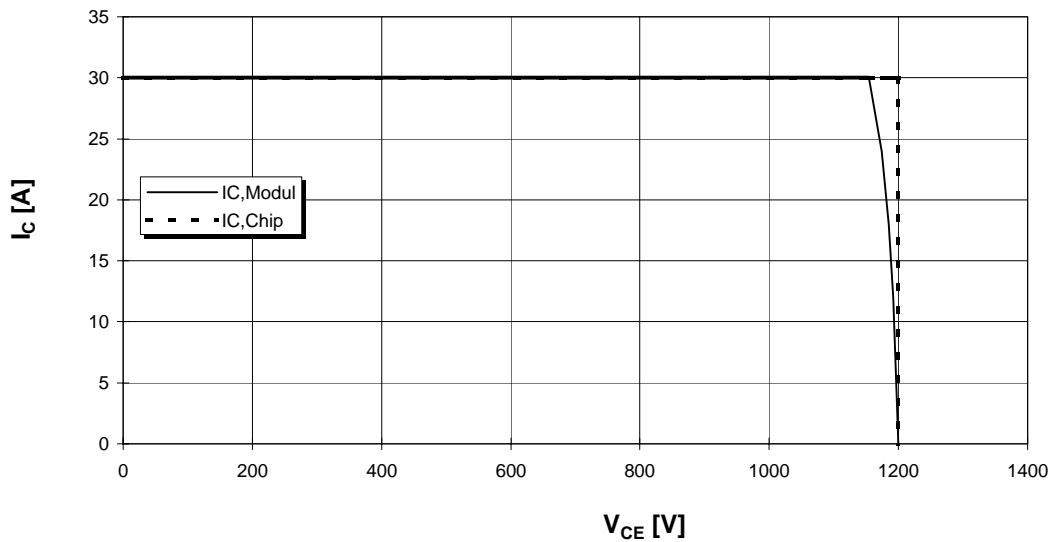

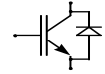

Econo 2 (shortpin)

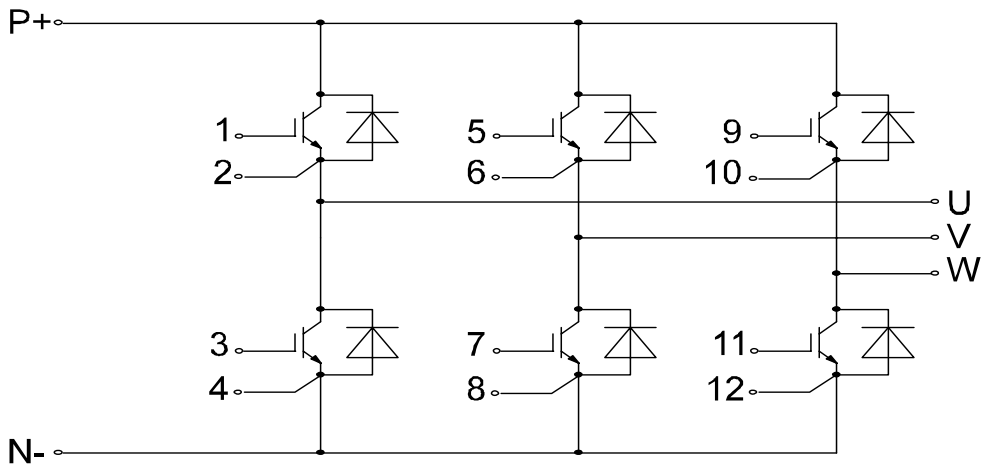
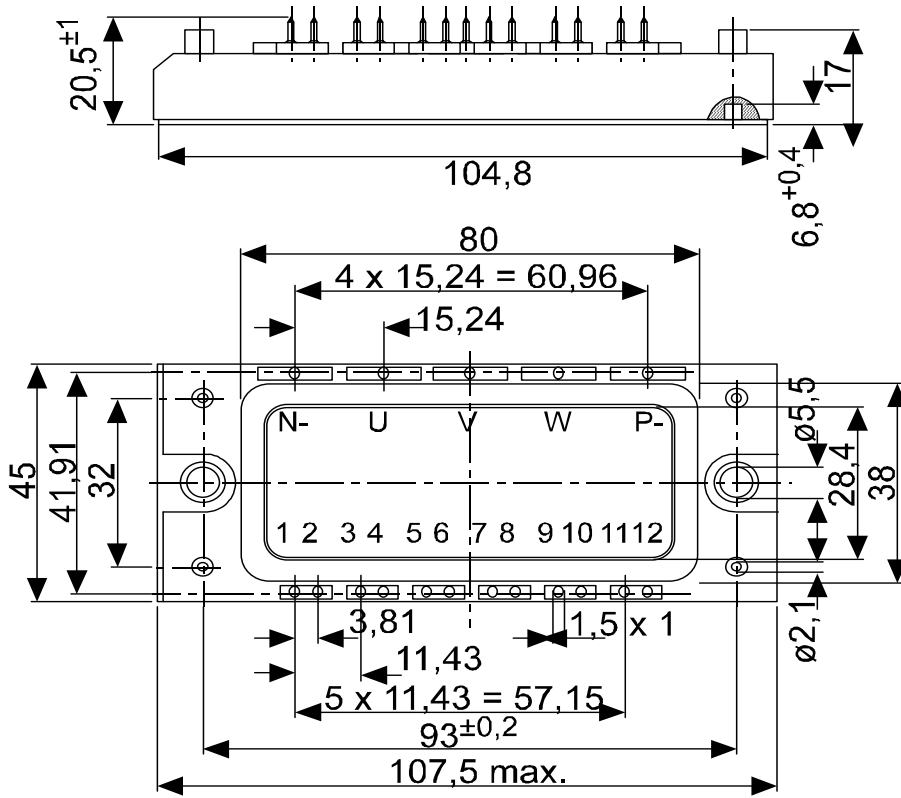

Terms & Conditions of Usage

Attention

The present product data is exclusively subscribed to technically experienced staff. This Data Sheet is describing the specification of the products for which a warranty is granted exclusively pursuant the terms and conditions of the supply agreement. There will be no guarantee of any kind for the product and its specifications. Changes to the Data Sheet are reserved.

You and your technical departments will have to evaluate the suitability of the product for the intended application and the completeness of the product data with respect to such application. Should you require product information in excess of the data given in the Data Sheet, please contact your local Sales Office via "www.eupec.com / sales & contact".

Warning

Due to technical requirements the products may contain dangerous substances. For information on the types in question please contact your local Sales Office via "www.eupec.com / sales & contact".